

ASSEMBLY INSTRUCTIONS



ROYAL SERIES

Table of contents:

CONTENTS	PAGE
GENERAL INFORMATION	
Important information	3
Assembly and safety instructions	4
Warranty statement	5
Instructions for use and information about the foundation	6
Information about the foundation – packaging info	7
Parts list	8 – 12
Twin-wall sheet plan	13
ASSEMBLING YOUR PROFESSIONAL GREENHOUSE	
Step 1: Connecting the longitudinal parts (floor profile, rain gutter, ridge) & the cross strut	14 – 17
Step 2: The floor frame	18 – 19
Step 3: The side corner profiles	20
Step 4: Fitting the rain gutters	21
Step 5: Fitting the cross struts	22
Step 6: Strut assembly (rear wall)	23 – 24
Step 7: Strut assembly (side wall)	25 – 27
Step 8: Door frame profiles	28 – 29
Step 9: Gable corner profiles	30 – 31
Step 10: The ridge	32
Step 11: Assembling the roof struts	33 – 36
Step 12: Inserting the twin-wall sheets	37 – 39
Step 13: Window stop	40
Step 14: Window assembly and installation	41 – 43
Step 15: Installing the door rail/assembling the door	44 – 45
Step 16 – Assembling and installing the door	46 – 50
Step 17 Final work	51
Step 18 – Screwing on the struts and profiles	52 -53

IMPORTANT INFORMATION

CHECKING PARTS LISTS

We strongly recommend checking the parts of the frame as well as the twin-wall sheets for completeness on the basis of the parts list.

With the guarantee that all parts are completely available, a continuous structure is ensured and you save time and hassle of having to stop assembly.

ATTENTION:

To rule out shortfalls as far as possible, we use **the most modern weighing techniques**, and the individual packing steps are **continuously and fully monitored by exact weight checks**.

This allows us to largely rule out any shortages or any mixing up of parts.

However, if a part is damaged during transport, or if a part is missing, we will send it to you as quickly as possible.

REQUEST:

The manufacturer / importer is GFP Handels GesmbH, Passauerstr. 24, A-4070 Eferding, Austria (hereinafter also referred to as "the manufacturer", "we" or "us").

If you have any questions about the assembly or the product itself, please contact the supplier through whom you purchased your product.

COMPLAINT CLAIMS FOR TWIN-WALL SHEETS

Sometimes when stapling the wall sheet cartons, **sheets** can be **slightly damaged at the side ends** by the stapler.

Please note that **twin-wall sheets normally do not have closed side edges** and this is a unique feature we offer.

Therefore, **minor damage** (any damage no longer visible either after insertion into aluminium profiles or after attachment of the rubber seal – i.e., no longer visible **further than approx. 7 mm** into the sheet) **do not constitute grounds for complaint**, since neither the function nor the appearance is impaired as a result.

Exchanging sheets of this type is **only possible after returning the original sheets!**

Assembly and safety instructions

Dear Customer,

You have acquired a meticulously constructed greenhouse, made by people for whom precision has become a tradition. The compact design allows for quick assembly. The possible applications are very versatile.

We reserve the right to make further developments in the interest of technical progress.

We ask for your understanding that there may be minor deviations from the illustrations and descriptions. We wish you every success with your new garden jewel.

PLEASE NOTE:

Before assembly, identify the aluminium profiles and check the quantities and dimensions.

Before assembling the greenhouse, make sure that no parts are missing on the basis of the individual parts list.

We are unable to pay any additional expenses or idle times arising from any inspection not carried out in advance for any installation companies commissioned.

If spare parts are required, please contact the supplier. Please let them know the item number of the part you need.

With twin-wall sheets, it should be noted that there is an interior side and an exterior side. The side covered with film or the side labelled "outside" is covered with a UV-protective coating. To avoid confusion, always remove the foil after inserting each sheet.

The foundation can be made of concrete or masonry. Your greenhouse must have a firm footing and must be properly secured (see sketches on page 3) – we therefore strongly recommend that you place the greenhouse on a foundation.

CAUTION – Safety instructions for assembly!

Assembly should be carried out by 2 people. We recommend wearing protective gloves, safety goggles and safety shoes when assembling the frame and glazing (risk of injury and breakage!). After complete assembly, all screw connections must be tightened again using an open-ended or ring spanner.

NOTE!

The manufacturer is not liable for storm, wind, water or snow load damage (**we recommend that you remove snow from the roof during the winter months**). The warranty does not cover compensation for consequential damage or financial loss. If there is visible damage to components, they must be replaced with original spare parts.

TOOL LIST:

The following tools are required for assembly:

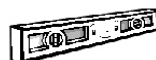

EXPLANATION OF SIGNS AND TERMS:

The following symbols are used in our assembly instructions:



Attention!
Important!



This
component



component is
moved!



Assembly
order

Danger of explosion!

The product can heat up strongly due to solar radiation. Explosive substances may explode and highly flammable or combustible substances may catch fire if stored in the product.

Do not store highly flammable, highly combustible or explosive substances in the product.

Danger of suffocation!

Small children can put individual assembly parts in their mouths and swallow them or get caught in the packaging film. In both cases, they can suffocate in the process.

Keep small children away from all assembly parts and the assembly site.

Make sure that small children do not put small parts in their mouths.

Do not let children play with the packaging wrapper.

Risk of injury!

During assembly, there is a particular risk of injury for children and people with reduced physical, sensory or mental abilities. They may not be able to assess the risks correctly.

Keep children and people with reduced physical, sensory or mental abilities away from the product during assembly.

Do not allow children or people with reduced physical, sensory or mental capabilities to assemble, clean, maintain or repair the product.

Risk of injury!

When stepping on the roof, you can break through the roof due to your weight.

Do not walk on roof surfaces! Risk of falling!

Risk of damage!

Improper handling of the product may result in damage to the product.

Close the door and windows in wind and storms.

Free the product from snow and ice. The roof is not designed to support large amounts of snow.

A depth of 36 cm for dry snow, 10 cm for wet snow and 5.5 cm for ice correspond to a weight of approx. 50 kg/m².

The roof cannot support the weight of a person!

Do not place heavy materials on the roof or on the glazing sheets of the product.

Do not strike the twin-wall sheets with hard objects at low temperatures below freezing point.

These may break as a result.

Do not step on the product if the individual parts are cracked or deformed. Only replace damaged components with suitable original spare parts.

Do not group several products together in one location.

NOTE!

The manufacturer is not liable for storm, wind, water or snow load damage (we recommend that you remove snow from the roof during the winter months).

The warranty does not cover compensation for consequential damage or financial loss.

To prevent theft, we recommend installing a padlock on the sliding door (not included).

Before assembly check product and delivery contents

The product can be quickly damaged if you are not careful when opening the packaging with a sharp knife or another pointed object.

Be very careful when opening it.

- 1. Take the individual parts of the product out of the packaging.**
- 2. Check whether the delivery is complete.**
- 3. Check whether the individual parts of the product are damaged. If this is the case, do not assemble or use the product. Please contact our service centre.**

Determine the installation site

Improper handling of the product may result in damage to the product.

Place the product in an easily accessible location that provides a minimum of protection from the wind.

Only place the foundation and the product on sufficiently solid ground.

If possible, do not place the product at the edge of your garden, so that it is accessible from all sides.

Place the product on a suitable foundation and attach the product to it.

Place the product in a suitable location only.

Assembly instructions

Perform the assembly step by step and with great care. If you do not follow these assembly instructions exactly, mistakes can be made, which may be very dangerous.

Assemble the product with great care and step by step, as specified in the assembly instructions.

Wear protective gloves, goggles and safety shoes during assembly.

Blunt sharp edges on the aluminium profiles with a file so that you do not cut yourself or get caught on them.

Do not step on the roof of the product. There is a danger of falling off or through the roof.

Movements during the assembly operations can loosen screw connections again somewhat. As a result, the product can become unstable.

After assembly, tighten all screw connections using an open-ended or ring spanner.

Warranty statement

In addition to the seller's statutory liability for defects in greenhouses purchased from us, we also assume a 15-year warranty on the construction and frame and a 10-year warranty on our hollow chamber panels.

The warranty period begins with the date of taking charge of the goods. Any replacement deliveries shall not result in an extension of the warranty period.

The warranty for our greenhouses applies exclusively to the construction and frame.

Not covered by the warranty are delivery components such as seals, plastic parts and fasteners/joining elements. Similarly, the warranty does not extend to our extra greenhouse accessories.

The warranty for our twin-wall sheets extends exclusively to their weather resistance. It only applies in connection with the purchase of one of our greenhouses.

If justified claims arise under the warranty, the following warranty plan applies to the twin-wall sheets:

Time from date of purchase of material replacement	
Up to 5 years	100%
In the 6th year	75%
In the 7th year	60%
In the 8th year	45%
In the 9th year	30%
In the 10th year	15%

The basic prerequisite for claims under the warranty is a professional installation and proper maintenance of both the frame and the hollow-chamber twin-wall sheets.

The warranty expires in the event of reassembly.

Furthermore, the warranty does not cover defects and damage directly or indirectly attributable to the following:

- Using a material in a way that does not comply with our instructions
- Damage caused by improper handling before, during or after the assembly work
- Damage caused by force majeure
- Inappropriate foundations and fastenings
- An unsuitable location (e.g., with a particular wind or heat load)
- Insufficiently secured greenhouse anchoring
- On-site modifications made to the delivered item
- Improper cleaning with unsuitable cleaning agents (including aggressive cleaning agents, salt water, etc.)
- Lack of product care (cleaning)
- Contact of the material with incompatible chemicals
- Incorrect installation of the double or triple-wall sheets and causing scratches and stresses, or the use of incompatible adhesives or sealants or other incompatible materials

Materials

- Colour changes to the powder-coated surface caused by solar radiation
- A surface change of the press-finished parts caused by the formation of a natural oxide layer
- Maintenance joints (silicone joints)
- Commercial use

Warranty claims can only be made with the original purchase receipt, provided that the customer has fulfilled all payment obligations under the purchase contract.

If a warranty claim is made within the granted warranty period and is considered to be justified, we will supply material replacement free of charge. This warranty does not cover any other warranty claims, such as compensation for direct or indirect damage or other consequential damage.

Any further liability, e.g., for the removal or installation of claimed or subsequently delivered parts, as well as for other ancillary costs or consequential damages, is not covered under this warranty.

Such liability exists only within the framework of the legal requirements.

The roof of your greenhouse must be cleared of snow and ice during the winter months!

Warranty in case of complaints/claims:

Despite careful handling in production and shipping, there may be reasons for claims. In this case, we therefore ask for your support so that the missing or defective parts can be delivered and/or re-delivered as soon as possible.

Therefore, to ensure a smooth assembly, we recommend checking the delivered goods for completeness and intactness using the supplied parts list before assembly.

If you find that parts are missing or damaged, please inform us of the parts you need by email so that we can arrange for them to be delivered as soon as possible.

The scope of warranty covers only the free replacement of the defective or broken part. Consequential or additional costs, in particular, delivery and assembly or conversion costs, are not included in the scope of warranty.

For information purposes, here is the legal basis, in brief, on which both we as a supplier and our customers may rely on:

Warranty

Warranty refers to customers' and buyers' rights to receive goods which are not defective. The defects at the time of purchase can be very different in nature:

- The product does not function as promised and expected.
- The product does not correspond to the specified and purchased size.
- The external part of the product is defective.

If such a defect becomes apparent, then the warranty is valid for a period of two years. The buyer can report this defect through a complaint to the seller and demand rectification. On the other hand, a seller is not obliged to exchange the product.

What is a buyer entitled to in the event of a complaint?

The law defines exactly what rights and claims buyers have in the event of a complaint. Buyers should note that the law divides the claims into two successive stages. In plain language, this means: if a buyer submits a complaint, they cannot immediately withdraw from the purchase contract. Nor can they immediately claim compensation in monetary form, although the law lists this as an eventual possibility. In the event of a complaint, the seller must first be given the opportunity to repair the product. This is done, for example, by...

- repairing the product.
- exchanging the product.

Only if the seller lets a deadline elapse and does not comply with the claim for rectification due to the complaint, can buyers withdraw from the purchase contract or claim financial compensation in the second step.

Based on the legal basis, the following applies:

- ➔ Warranty claims are limited to the replacement of faulty or missing material.
- ➔ There will only be financial compensation, without exception, if we are unable to remedy the defect by replacing the product!
- ➔ Defective components that have already been installed or painted are excluded from replacement.
- ➔ All other claims are excluded!

Instructions for use and information about the foundation

INSTRUCTIONS FOR MAINTENANCE AND USE:

- Every 3 to 4 months, check the screw connections of your greenhouse and tighten them if necessary.
- After strong winds or storms, Ensure that the twin-wall sheets and screw connections are fitted securely.
- In windy and stormy weather, windows and doors must be closed.
- When temperatures are below freezing, do not strike the twin-wall sheets with hard objects.
- The roof of your greenhouse must be cleared of snow and ice during the winter months. (Caution! – The roof cannot support the weight of a person!)
- The national building regulations must be observed.

FOUNDATION

You can place your new greenhouse on a previously constructed concrete or masonry foundation (see Figure 1). The foundation must be right-angled and level. Place your finished greenhouse on the foundation. You have two options for securing the greenhouse:

OPTION A:

Drill a hole through the floor profile. (See detail A). Secure the greenhouse to the foundation with suitable screws and dowels.

OPTION B:

Securing the greenhouse using brackets. These brackets can be fixed to the floor profile using screws (see detail B). No drilling work on the greenhouse is necessary for this. The greenhouse can then be attached to the foundation with suitable dowels and screws. (The brackets are not included in the delivery.)

NOTE! Dowels, screws and ground anchors are not included in the delivery. Your greenhouse is made of lightweight aluminium and hollow twin-wall sheets. Neither has a particularly heavy weight. However, storms and wind have a particularly large loading surface. For this reason, anchor your greenhouse particularly securely to the floor. Pay particular attention to the quality of the materials used!

CONCRETE OR MASONRY FOUNDATION

Here, you will find the matching dimensions:

Model	Width [B] Inner dimensions	Length [L] Inner dimensions	Height [H]	Level [K]
ROYAL greenhouse	2160 mm	2920 mm	approx. 80 cm	min. 50 mm

Figure 1:

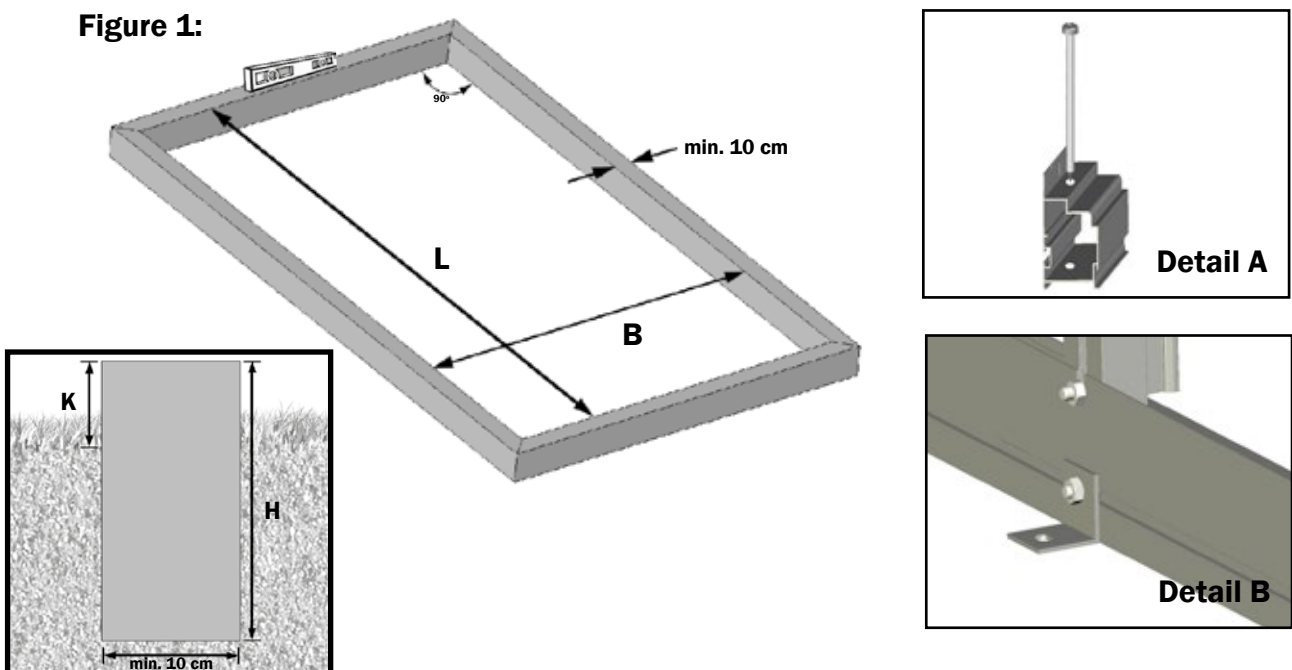

Information about the foundation – packaging info

A supporting role – the greenhouse foundation

With a solid greenhouse foundation, do-it-yourselfers have the guarantee that their building will withstand extreme weather conditions and that their valuable plants will be reliably protected against the weather.

As a load-bearing substructure, the greenhouse foundation should guarantee structural integrity under all conceivable weather conditions. The foundation must be capable of absorbing all static forces such as dead load and roof load, wind pressure and wind suction.

Furthermore, it must not sink into the ground or lift off from the ground if it is a lightweight construction. Also, the function for protecting against heat loss into the ground must not be forgotten, since this is particularly important for the plants in the greenhouse.

Installing a greenhouse in the garden without appropriate anchoring is not recommended.

Does every greenhouse need a foundation?

In principle, a foundation is required for almost every project in which a building is in contact with the ground. **A greenhouse should also stand on a firm foundation.**

Overview of common foundation options



ATTENTION, IMPORTANT INFORMATION ON PACKAGING!















The individual parts are packaged into the different boxes exclusively according to logistical considerations, which does not correspond to the order of the assembly steps!

Please open all frame boxes before starting your assembly work and sort out the parts according to the parts list – this is the only way to ensure a simple, smooth assembly!











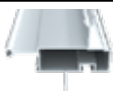



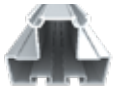



(The boxes with glazing can remain closed until you start with the glazing work!)

Parts list

PACKAGE 1 of 3 - "ROYAL"

SKETCH	PART. NO.	DESIGNATION	LENGTH	QTY.
	9140014	Floor profile 3 sections	2231 mm	2
	9040143	Side corner profile	1633 mm	4
	9040068	Side wall strut	1633 mm	6
	9140112	Roof support	521 mm	2
	9140150	Entrance/door frame upright	1633 mm	4
	9140168	Cross strut, single door	2231 mm	2
	9040200	Wind band	1772 mm	8
	9040201	Wind band	1400 mm	4
	9140266	Upper door rail	1494 mm	1
	9140280	Lower door rail	1494 mm	1
	9140303	Door roller profile	767 mm	2
	9040211	Window stop profile	771 mm	2
	9040242	Window profile, side	617 mm	4
	9140235	Lower window profile	750 mm	2
	9140228	Hinge profile	750 mm	2



PACKAGE 2 of 3 - "ROYAL"

SKETCH	PART. NO.	DESIGNATION	LENGTH	QTY.
	9040136	Gable corner profile	1223 mm	4
	9140007	Floor profile 2 sections	1494 mm	4
	9140045	Ridge 2 sections	1494 mm	2
	9040075	Roof strut	1223 mm	4
	9140082	Coupling strut, sidewall	1633 mm	2
	9140099	Coupling strut roof	1223 mm	2
	9040518	Connector, 20x20 mm	250 mm	5
	9040563	Reinforcement ridge (1 hole)		1
	9040570	Reinforcement rain gutter (2 holes)		2
	9040311	Window stay		2
	664555	Axle pin		4
	NG209	Door roller		4
	9040344	Fastening clip		2
	9040341	Brackets for floor profile		4
	9040358	Door handle, inside		1
	9040365	Door handle, outside		1
	665973	Door rail protection		1
	3901411	Aluminium self-adhesive tape	50 m	1







Continued on page 10

Parts list

PACKAGE 2 of 3 - "ROYAL"

SKETCH	PART. NO.	DESIGNATION	LENGTH	QTY.
	9040464	Ridge cover		2
	9040471	Drain pipe, left		2
	9040488	Drain pipe, right		2
	9040495	Covering cap, floor profile		4
	690509	M6x12 screws		130
	690523	M6x16 screws (possibly also delivered with the window stay)		2
	690547	M6 nut		20
	690548	M6 hexagon nut with flange		130
	690549	Self-locking M6 hexagon nut (possibly also delivered with the window stay)		2
	690592	Trapping screw, 4.8 x 22		24
	9040556	Drilling screw, 4.8 x 13		68
	690622	Rhombus screw		12

PACKAGE 3 of 3 - "ROYAL"

SKETCH	PART. NO.	DESIGNATION	LENGTH	QTY.
	9140021	Rain gutter 2 sections	1494 mm	4
	CT5120165	Half rubber, 165 cm	1650 mm	21
	CT5120125	Half rubber, 125 cm	1250 mm	16
	CT5130165	Whole rubber, 165 cm	1650 mm	6
	CT5130125	Whole rubber, 125 cm	1250 mm	5
	CT5100370	Door seal, 370 cm	3700 mm	1

Twin-wall sheet plan - "ROYAL" greenhouse

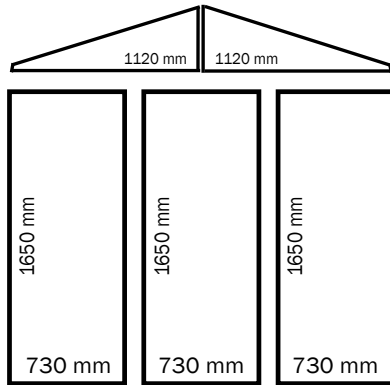

Rear wall

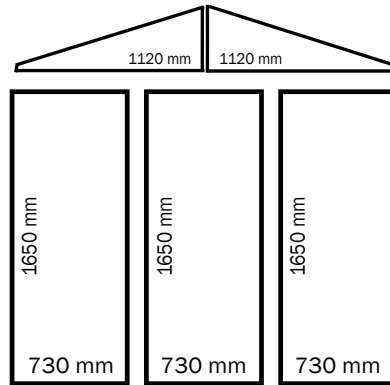

Front wall

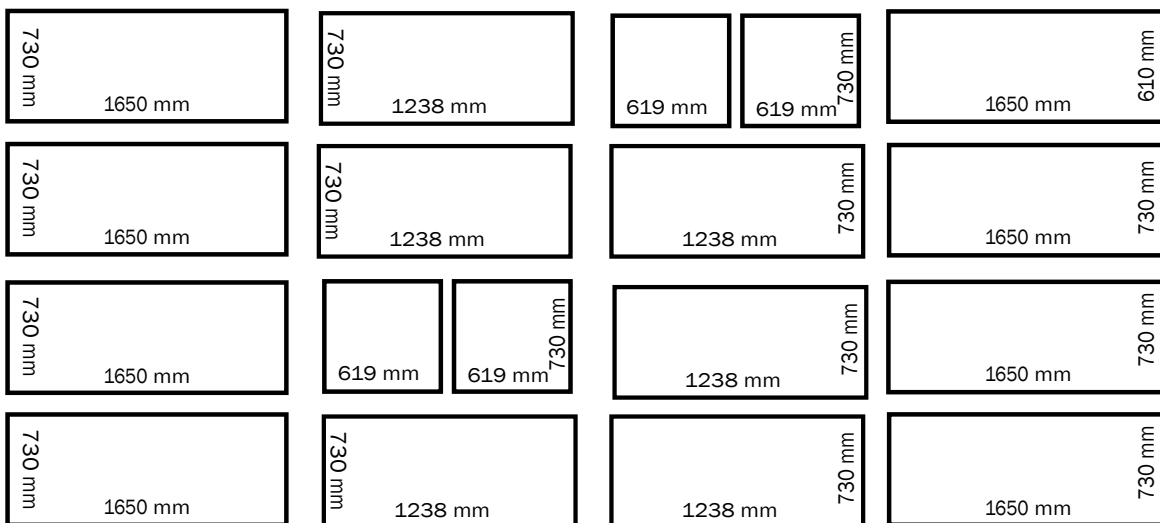

NOTE:

An aluminium adhesive tape is supplied to cover the upper edge of the twin-wall sheets. This prevents insects from getting trapped in the twin-wall sheets from above. We recommend not closing the underside of the wall sheets with the adhesive tape, so that any condensation water that may occur can drain downwards!

Step 1 – Connecting the floor profiles

STEP 1 – Connecting the longitudinal parts

In the first step, the floor profiles, rain gutters and ridge are connected using the supplied connectors. The floor, rain gutter and ridge must all be the same length!

1a

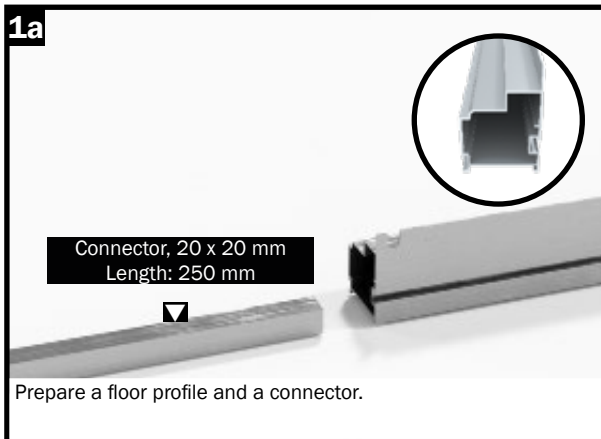

1b

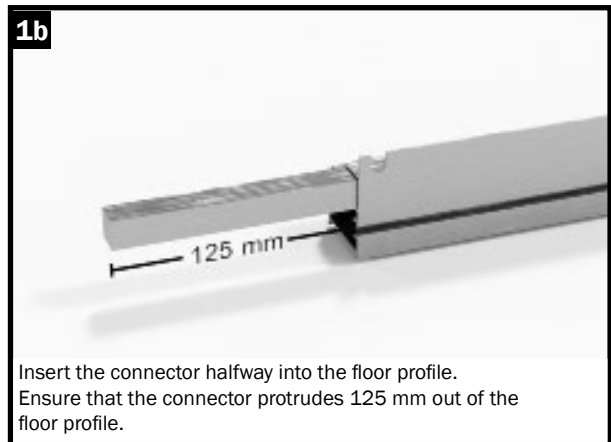

1c

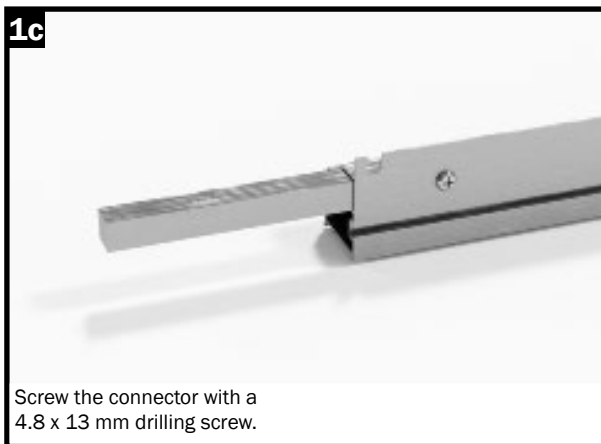

1d

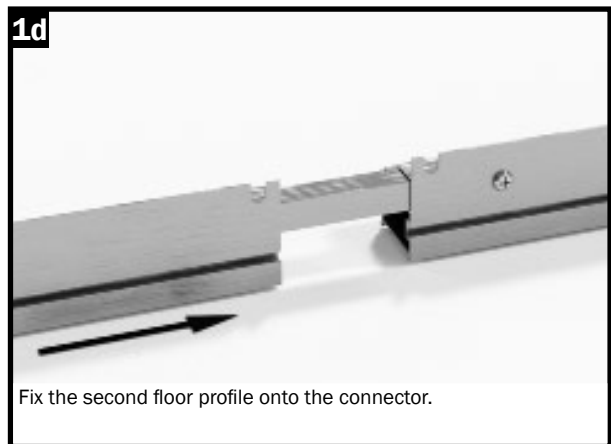

1e

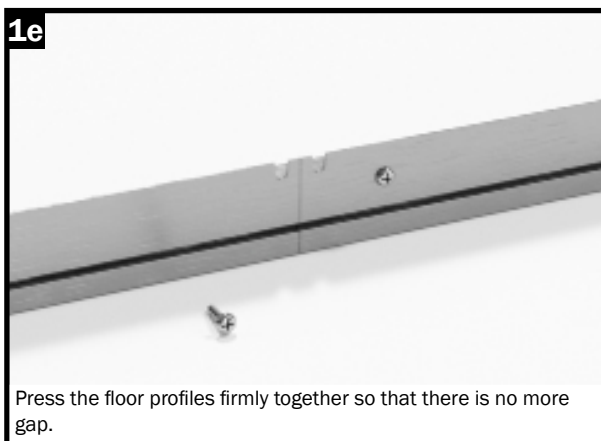

1f

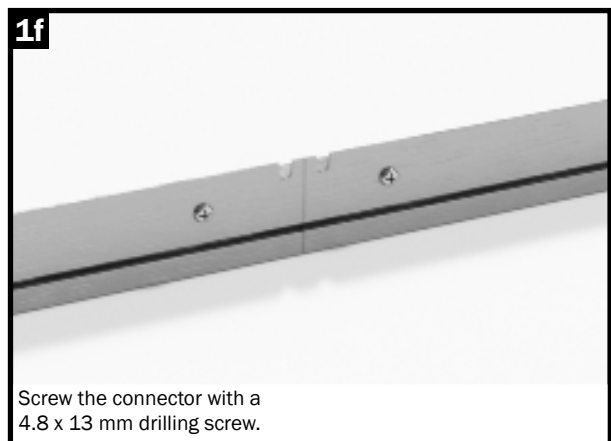

Step 1 - Connecting the rain gutters

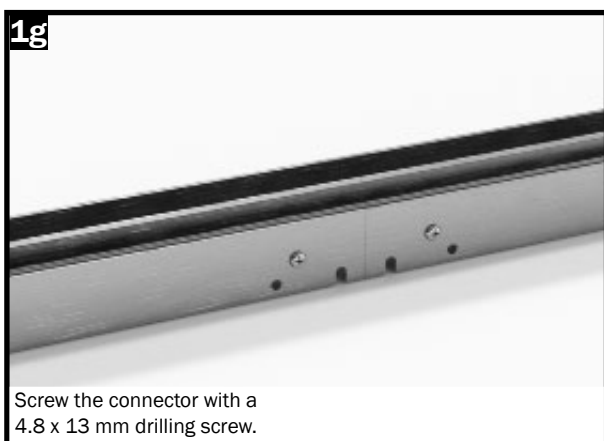
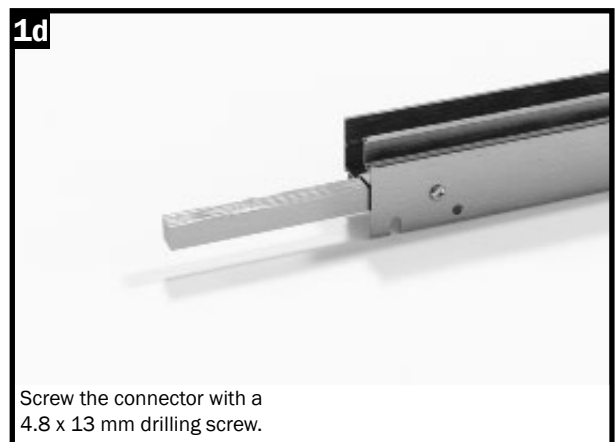
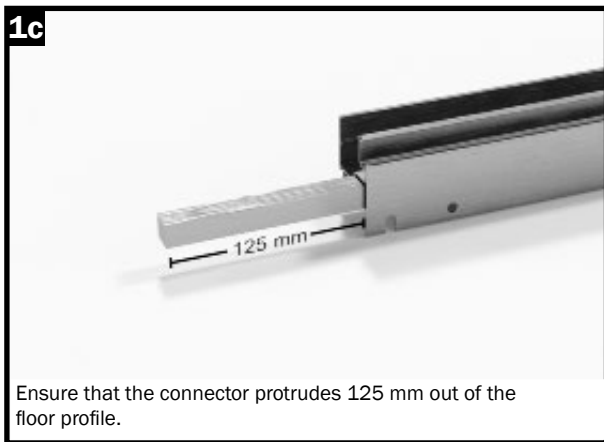

Step 1 - Connecting the ridge

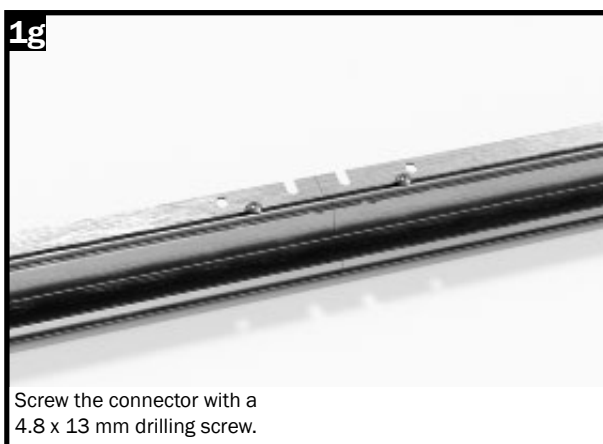
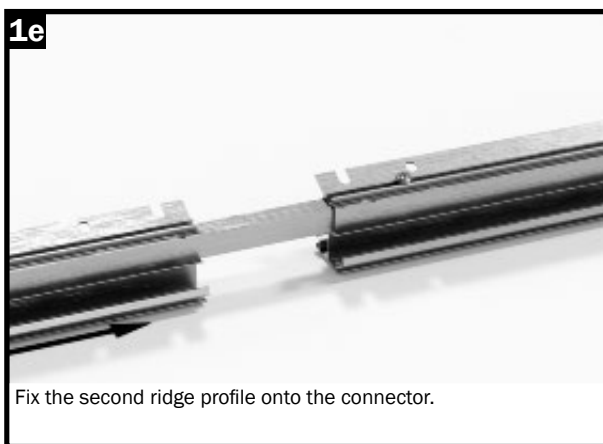
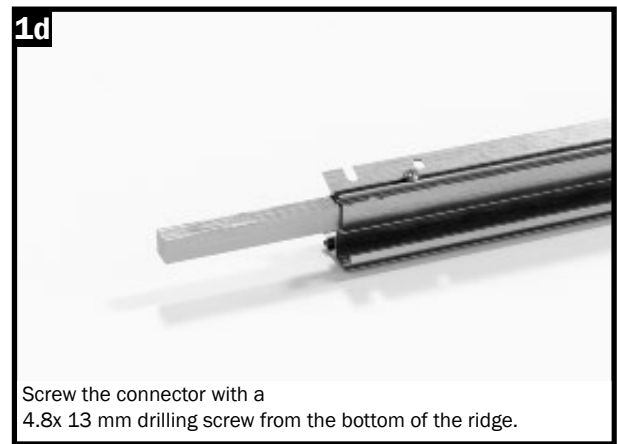
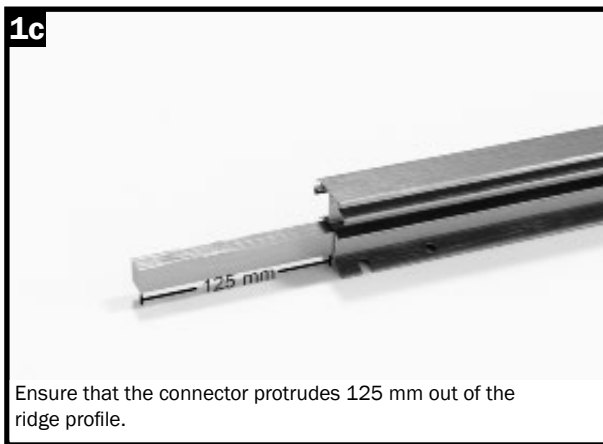
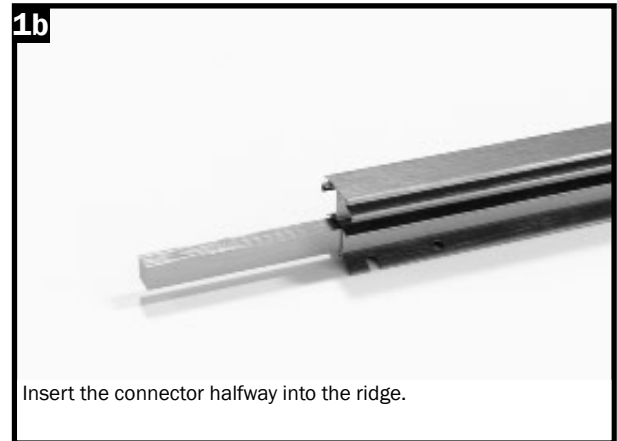
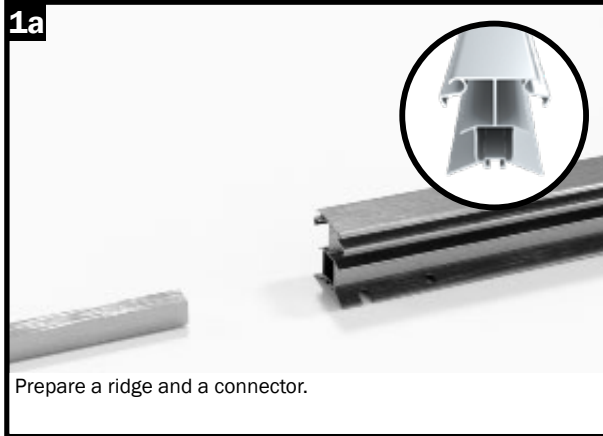

Step 2 – Assembling the floor frame

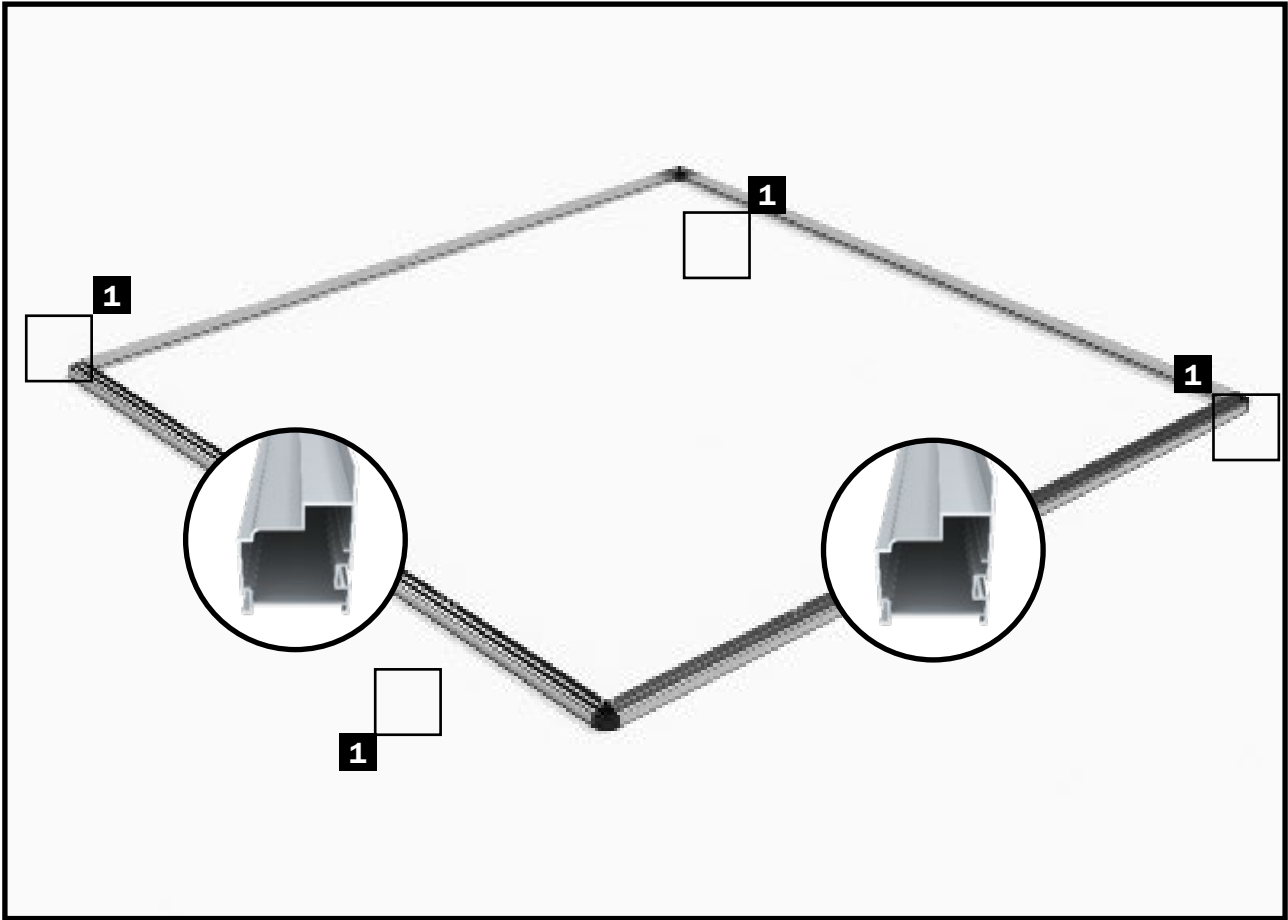

STEP 2 – Floor frame

In the following phase of assembly the floor profiles are joined at the corners. Before inserting the covering cap, insert an M6x12 screw each into the screw channel of the floor profile.

The floor profiles are screwed to the bracket (No. 9040341) using these M6x12 screws.

Note:

If you have also ordered a bracket set for the greenhouse, it would be advisable to insert the M6x12 mm screws into the screw channel beforehand.

1a Interior view

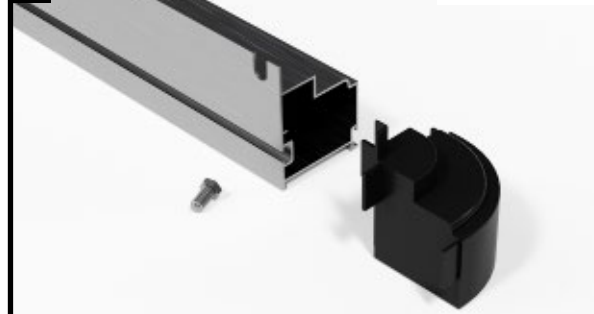

Prepare a floor profile of the front/rear wall together with a M6x12 screw and a covering cap.

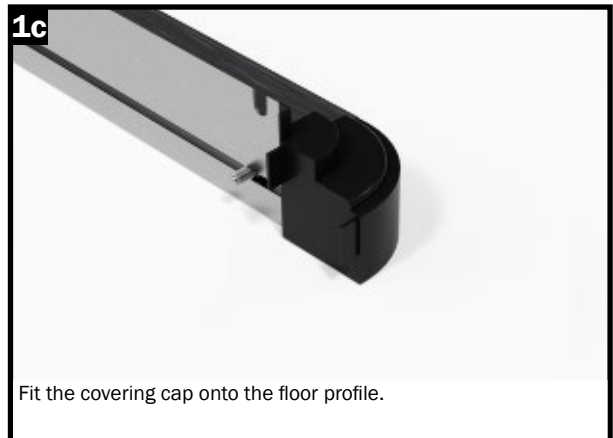
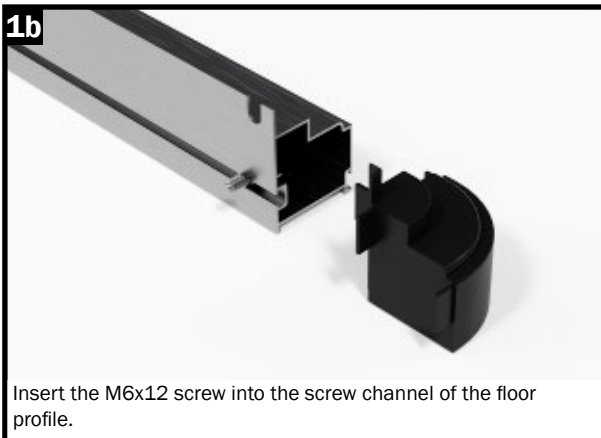

Step 2 – Assembling the floor frame

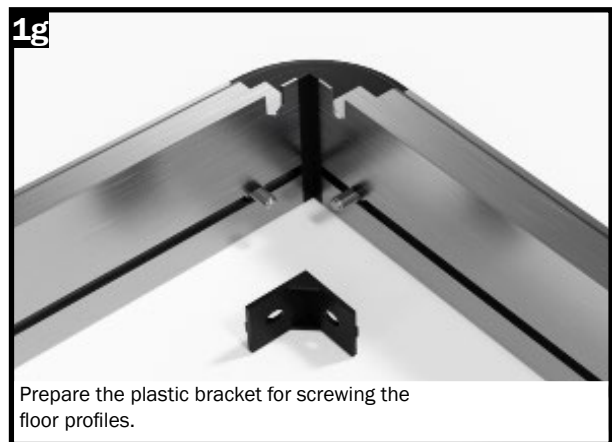
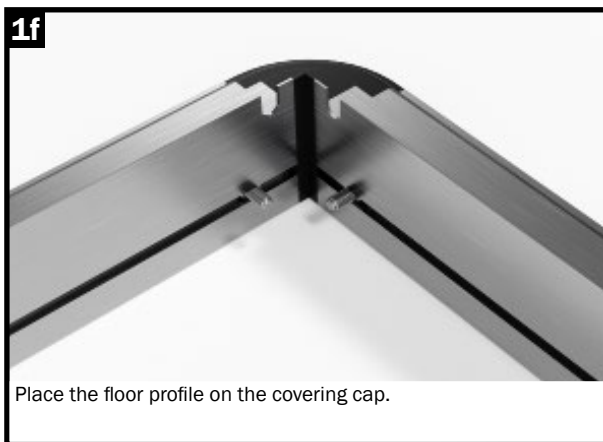
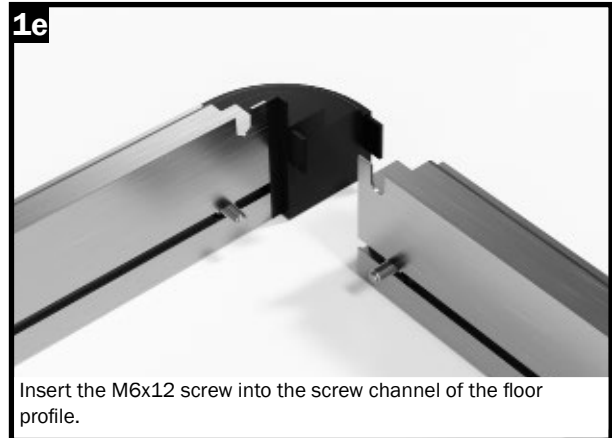

Step 3 – Assembling the side corner profiles

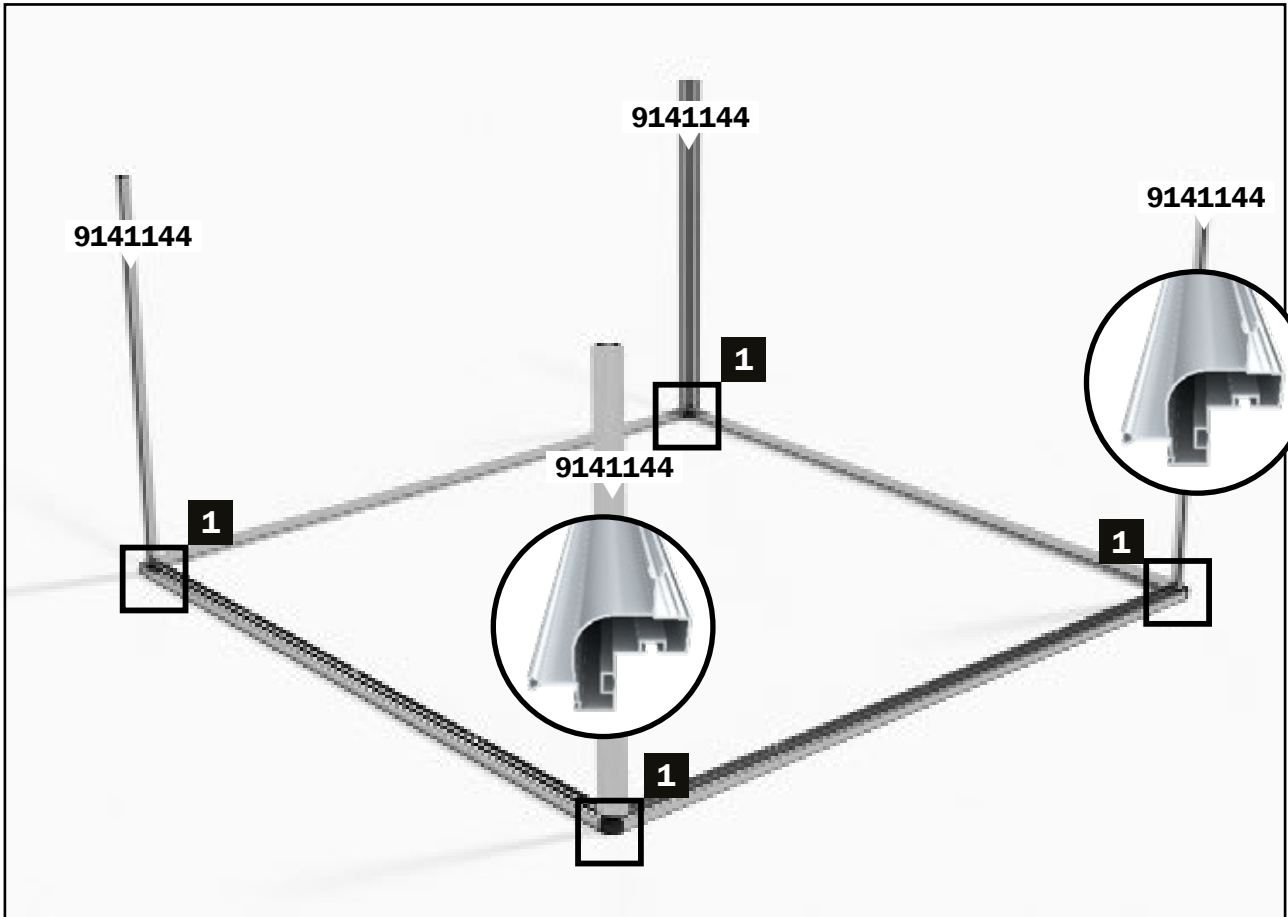

STEP 3 – Assembling the side corner profiles

In the following assembly phase, the side corner profiles are fitted onto the four corners. Before fitting the side corner profile, insert two M6x12 screws each into the screw channels of the side corner profile.

We recommend securing these screws with M6 nuts to prevent them from slipping.

Fit the side corner profile and screw it tightly with two M6 nuts.

Proceed the same way for all four corners.

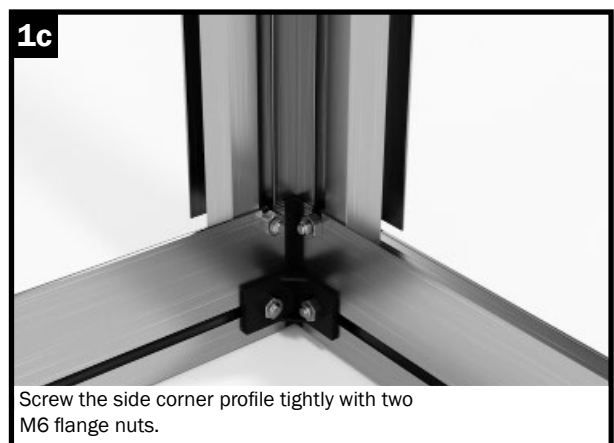
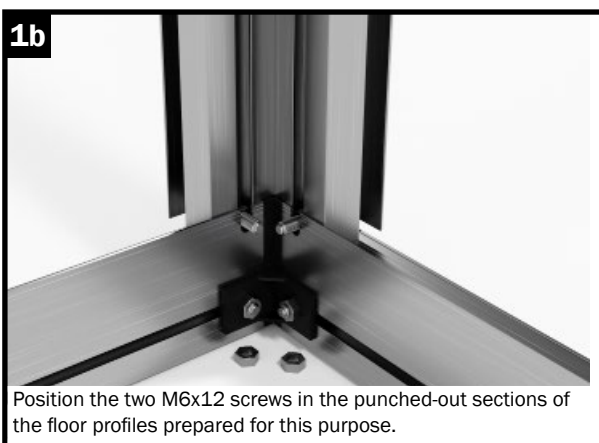
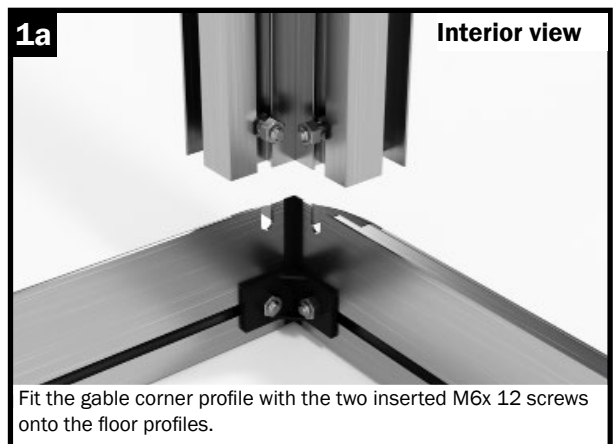

Step 4 - Fitting the rain gutters

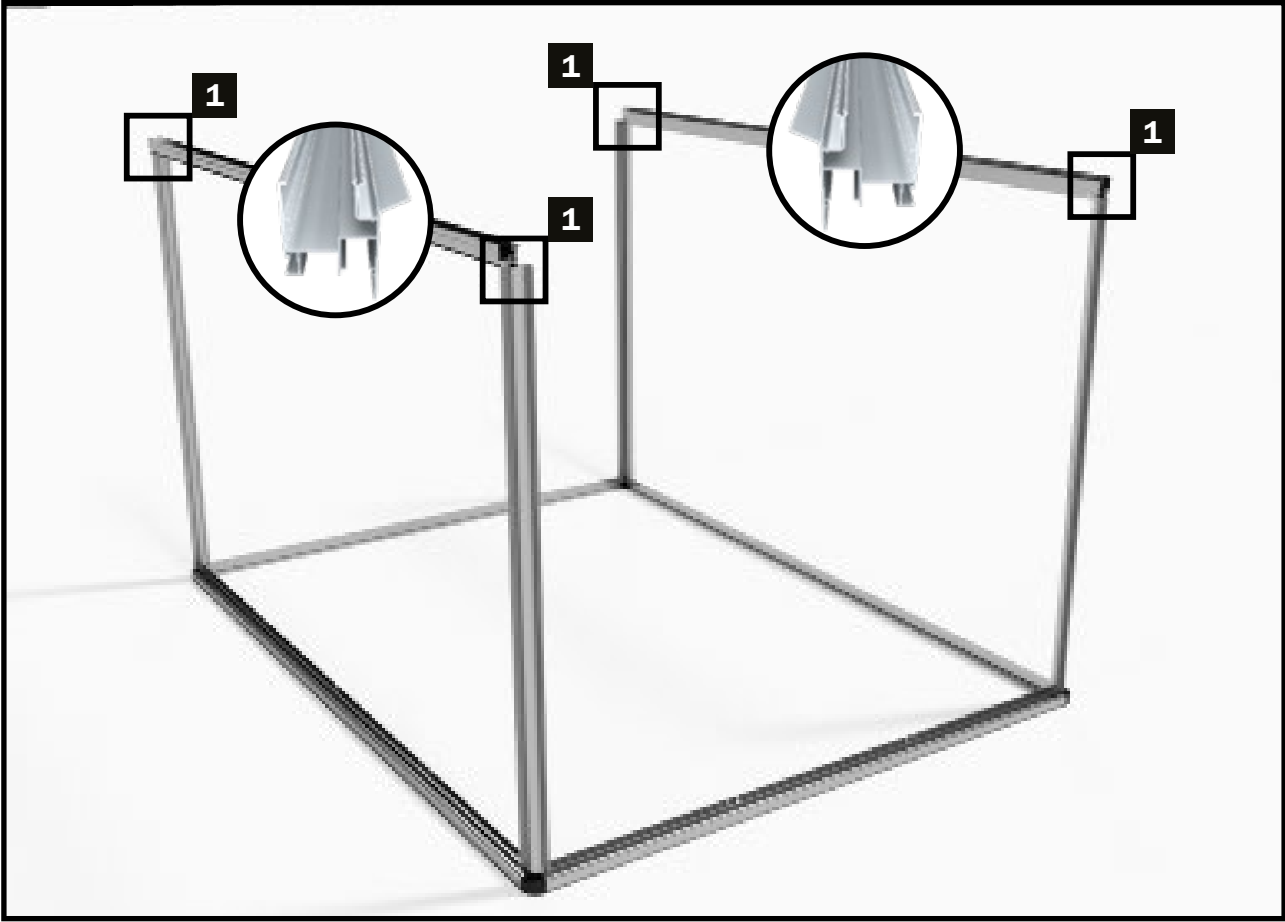

STEP 4 - Assembling the rain gutters

In the following assembly phase, the rain gutters are fitted onto the side corner profiles and screwed onto them.

This assembly step should be carried out by two persons so that the rain gutters can be screwed together parallel on both sides.

For this assembly step, prepare a rain gutter, M6x12 screws and M6 flange nuts.

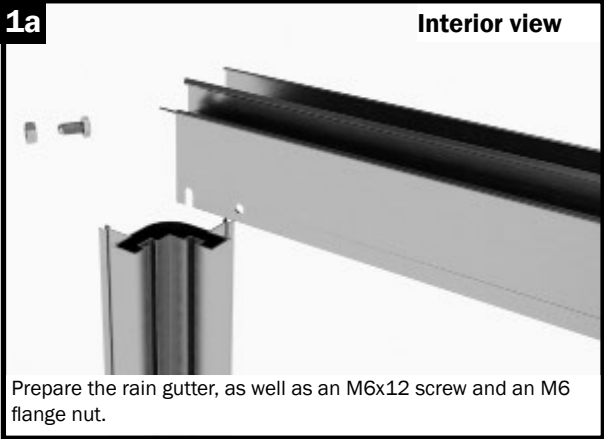

Step 5 - Fitting the cross struts

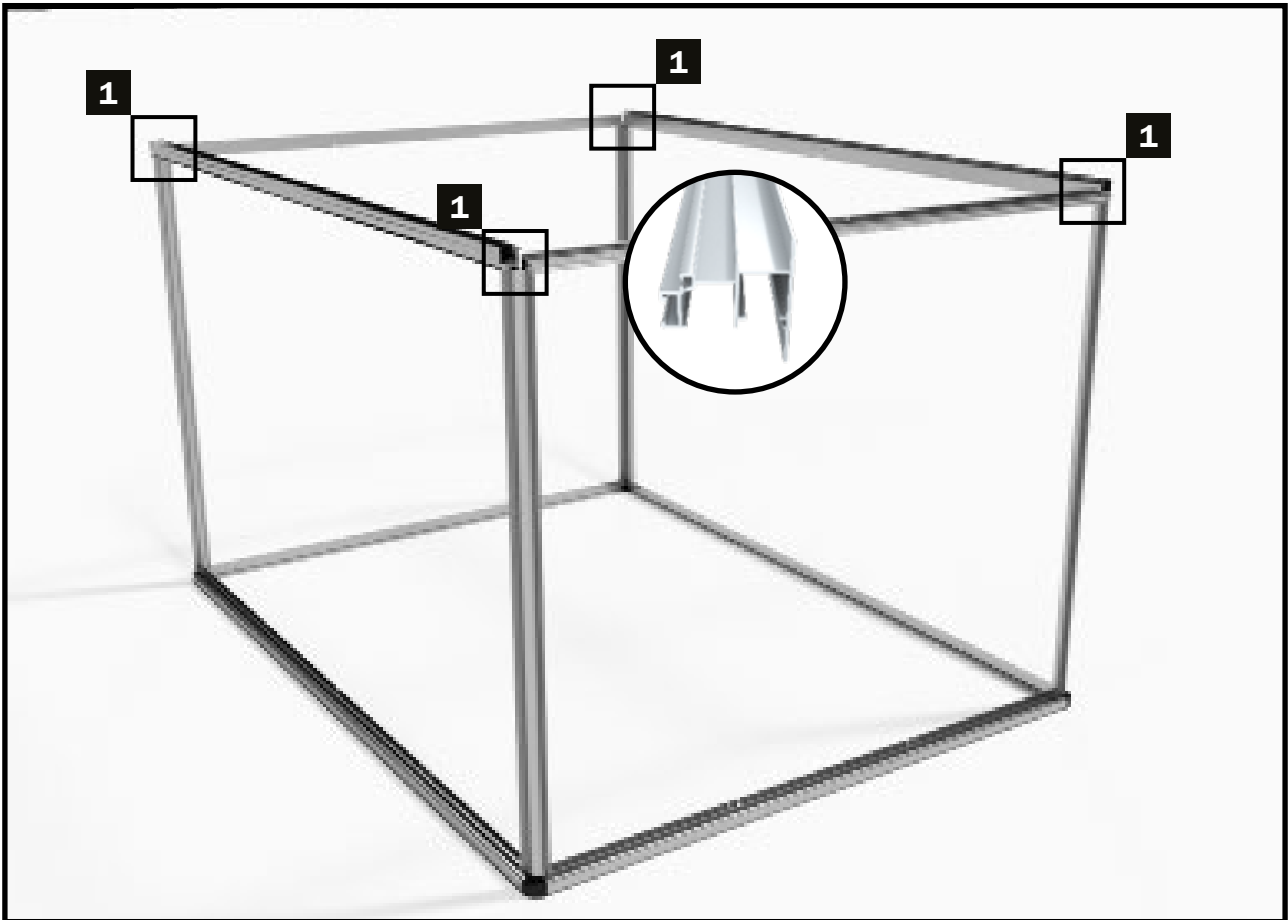

STEP 5 - Assembling the cross struts

In the following construction section, the cross struts of the front and rear walls are fitted onto the side corner profiles and screwed onto them.

This assembly step should be carried out by two persons so that the cross struts can be screwed together at the same time on both sides.

For this assembly step, prepare a cross strut, an M6x12 screw and M6 flange nuts.

1a



Prepare the cross strut, as well as an M6x12 screw and an M6 flange nut.

1b



Insert the M6x12 screw into the screw channel of the side corner profile and fit the cross strut.

1c



Screw the cross strut tightly onto the side corner profile using an M6 flange nut.

Step 6 – Assembling the rear wall struts

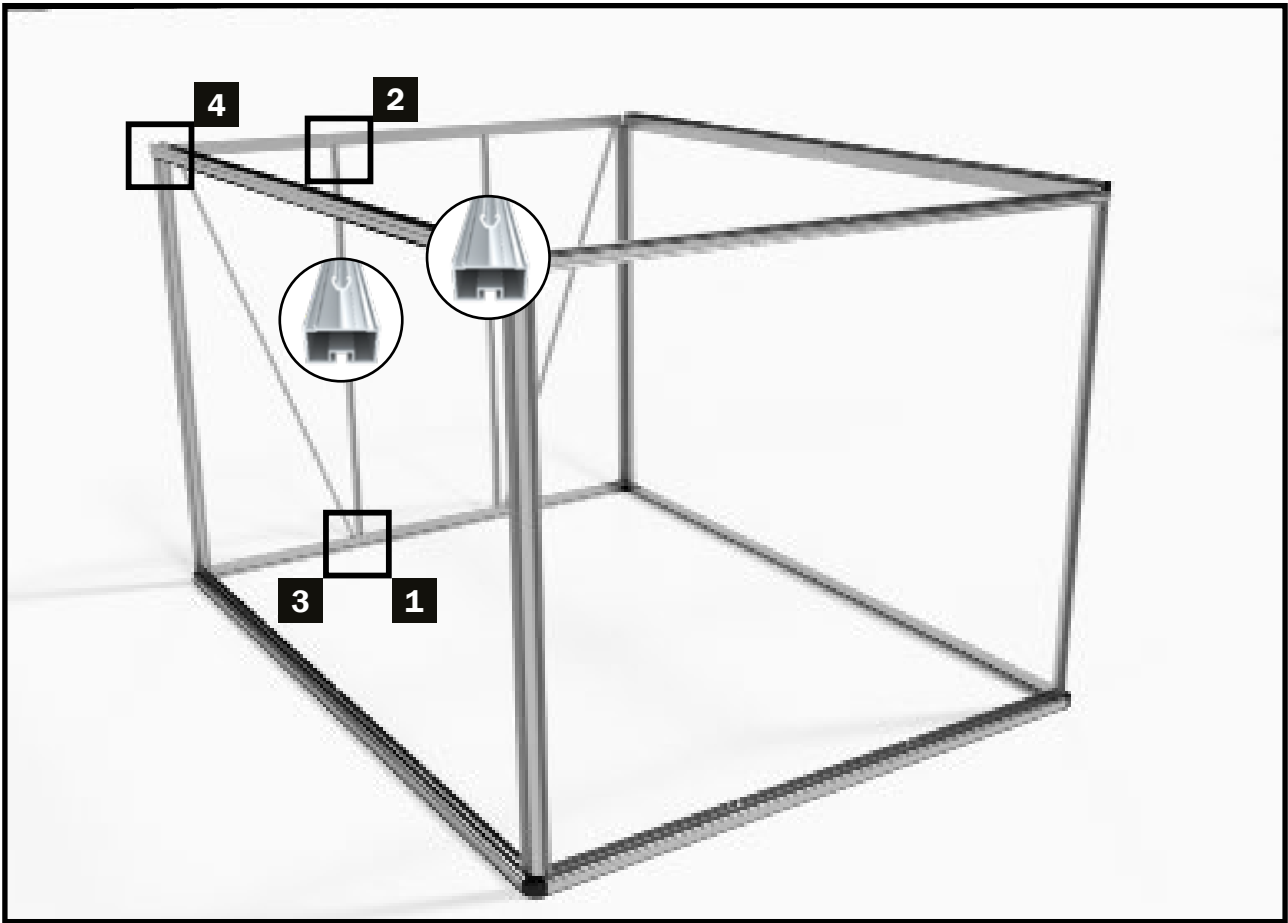

STEP 6 – Strut assembly of the rear wall

In the following assembly phase, the struts are installed on the rear wall, together with the two wind bracings.

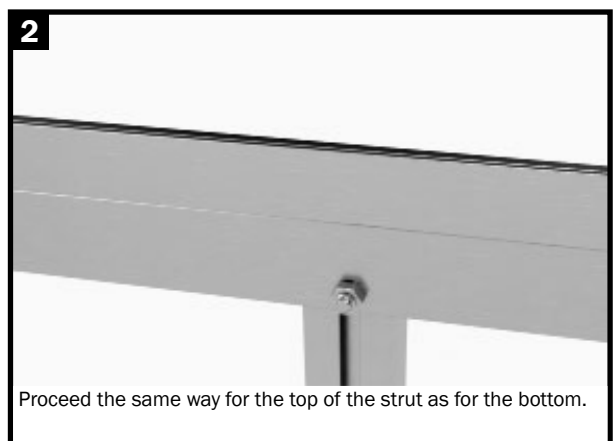
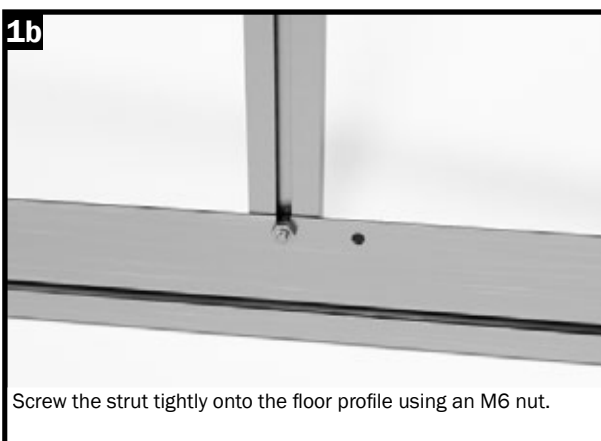
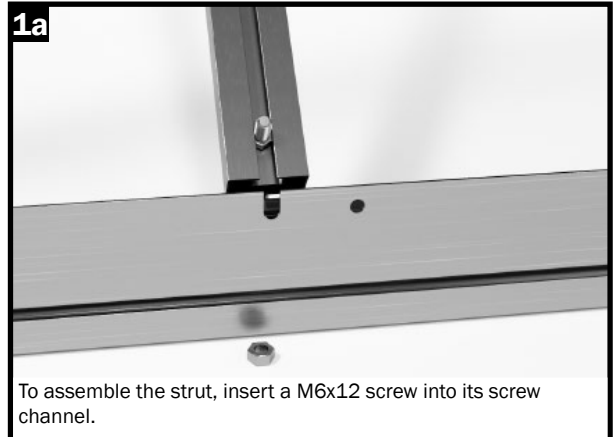

Step 6 – Assembling the rear wall struts

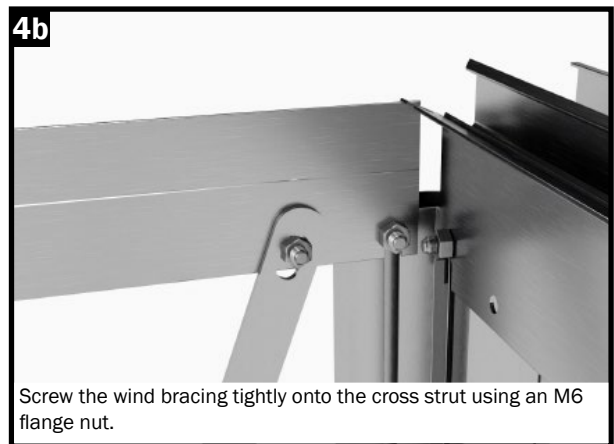
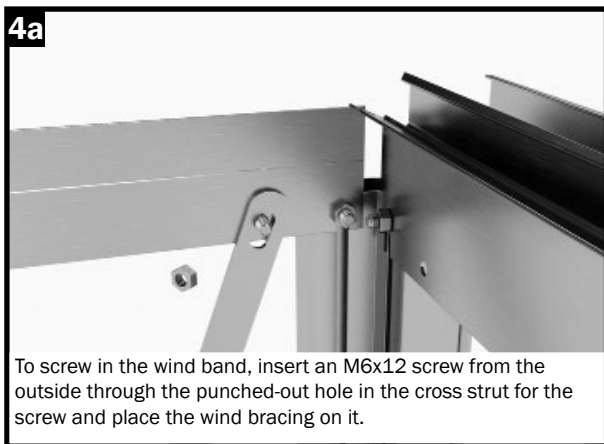
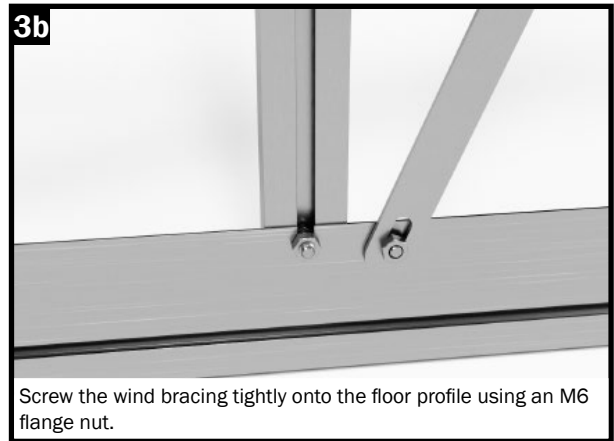
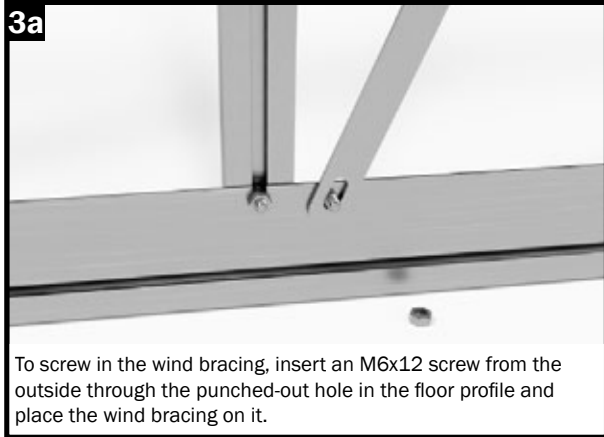

Step 7 – Assembling the side wall struts

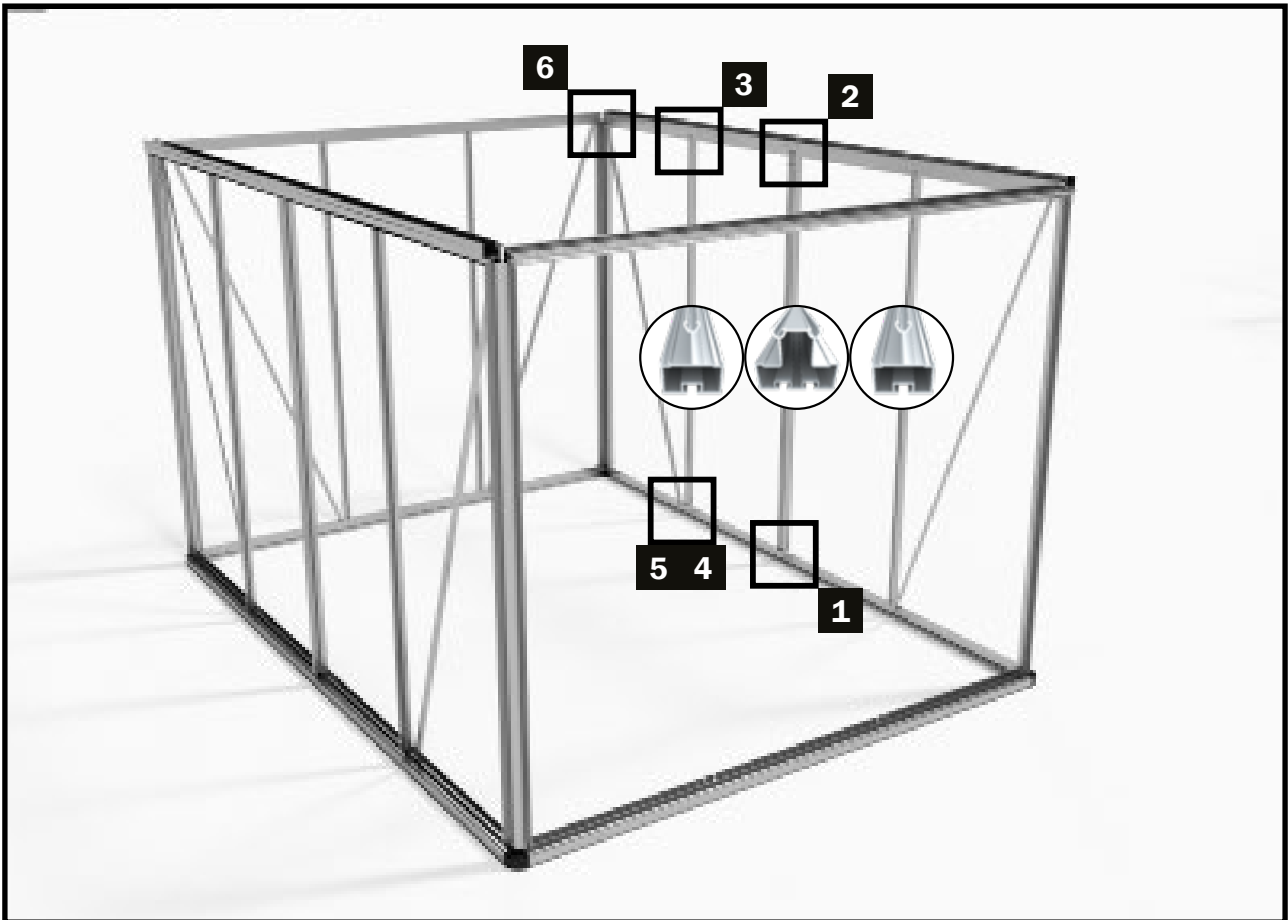

STEP 7 – Assembly of the sidewall struts

In the following assembly phase, the struts and the coupling struts are installed on the side walls, together with the respective two wind bracings.

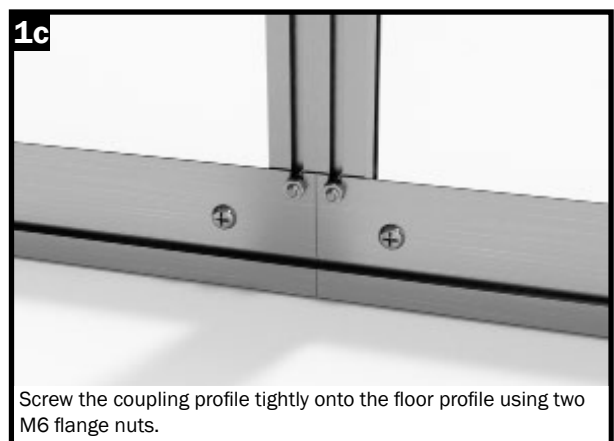
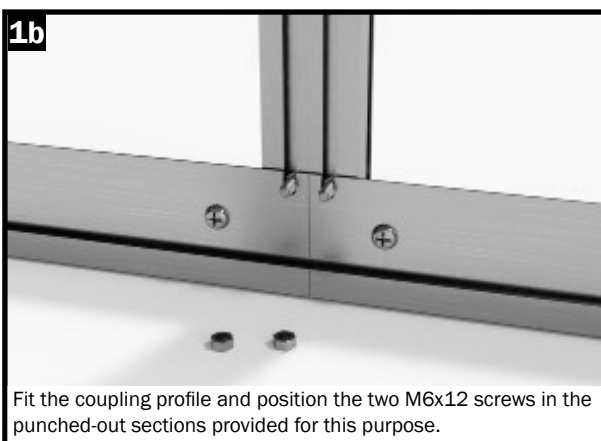
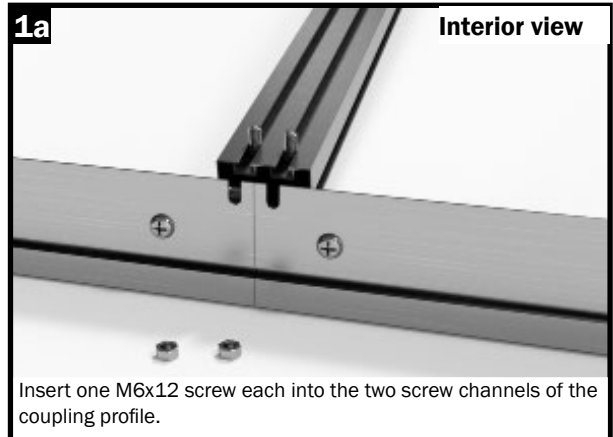

Step 7 – Strut assembly (sidewall)

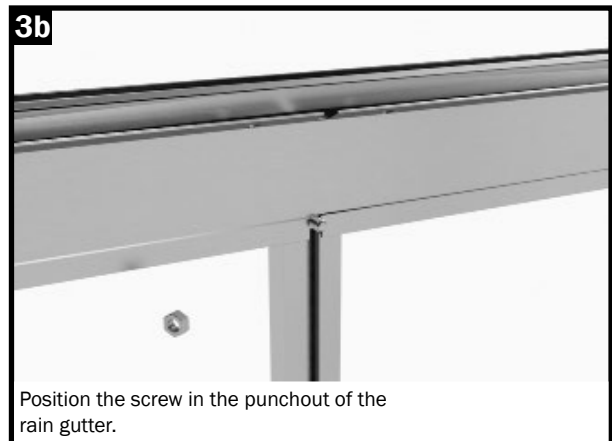
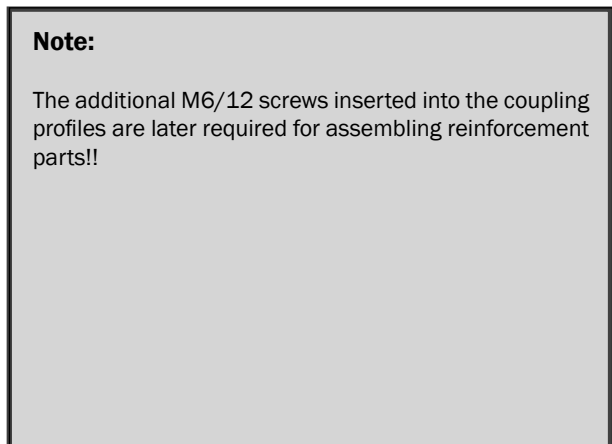
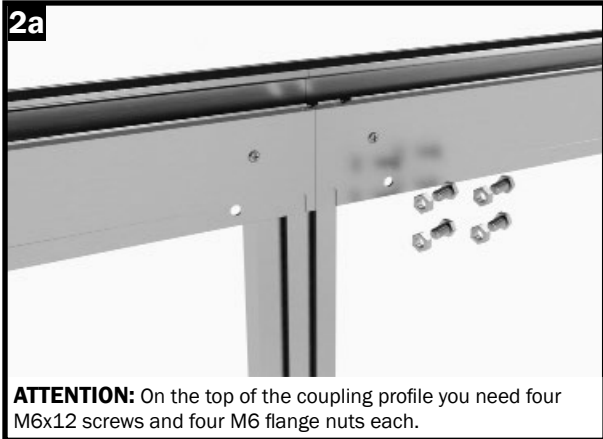

Step 7 – Strut assembly (sidewall)

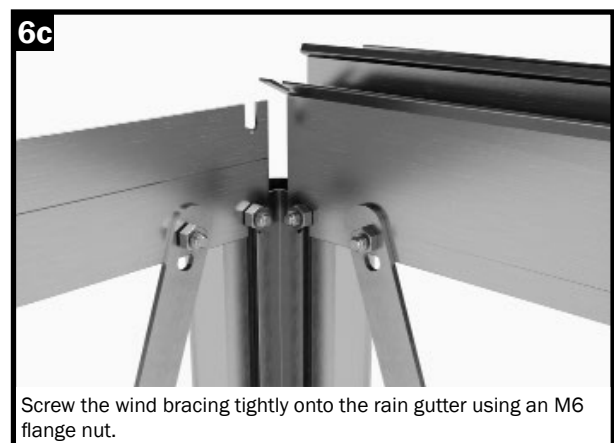
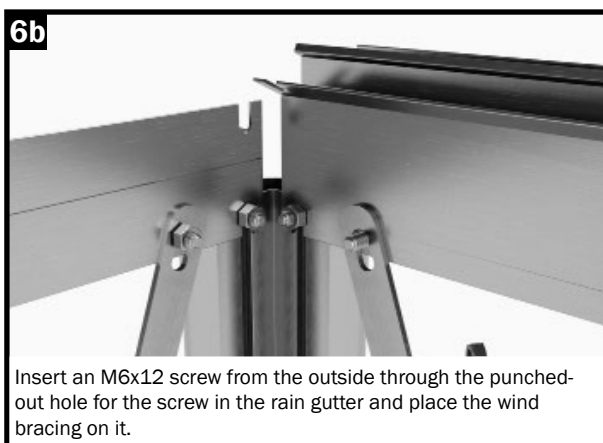
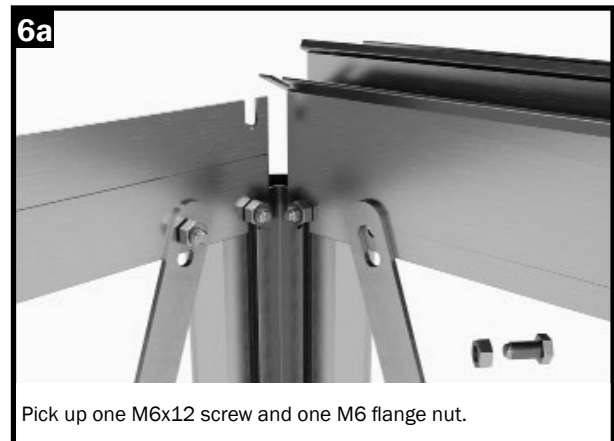
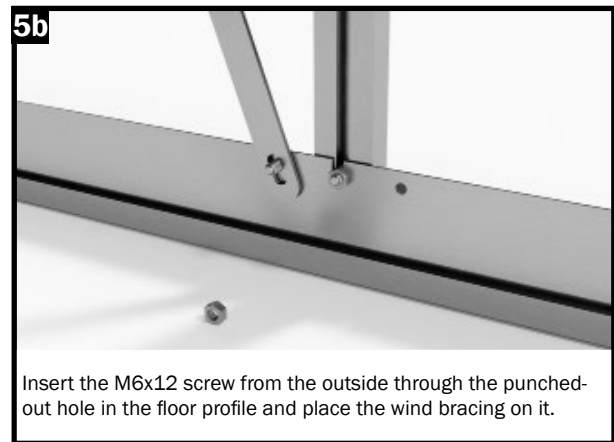
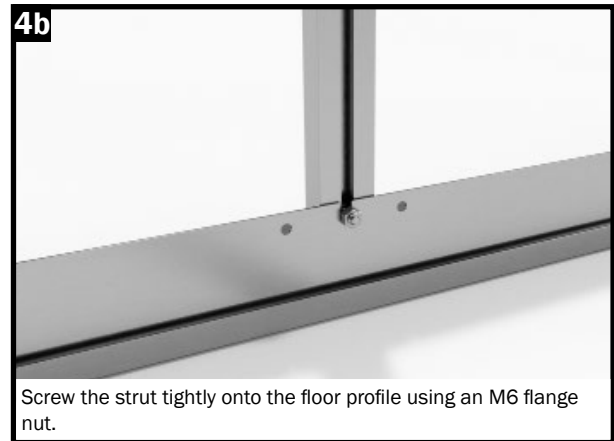
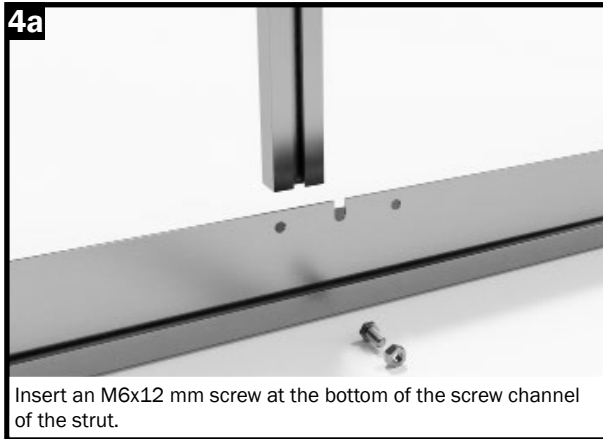

Step 8 – Assembling the door frame profiles

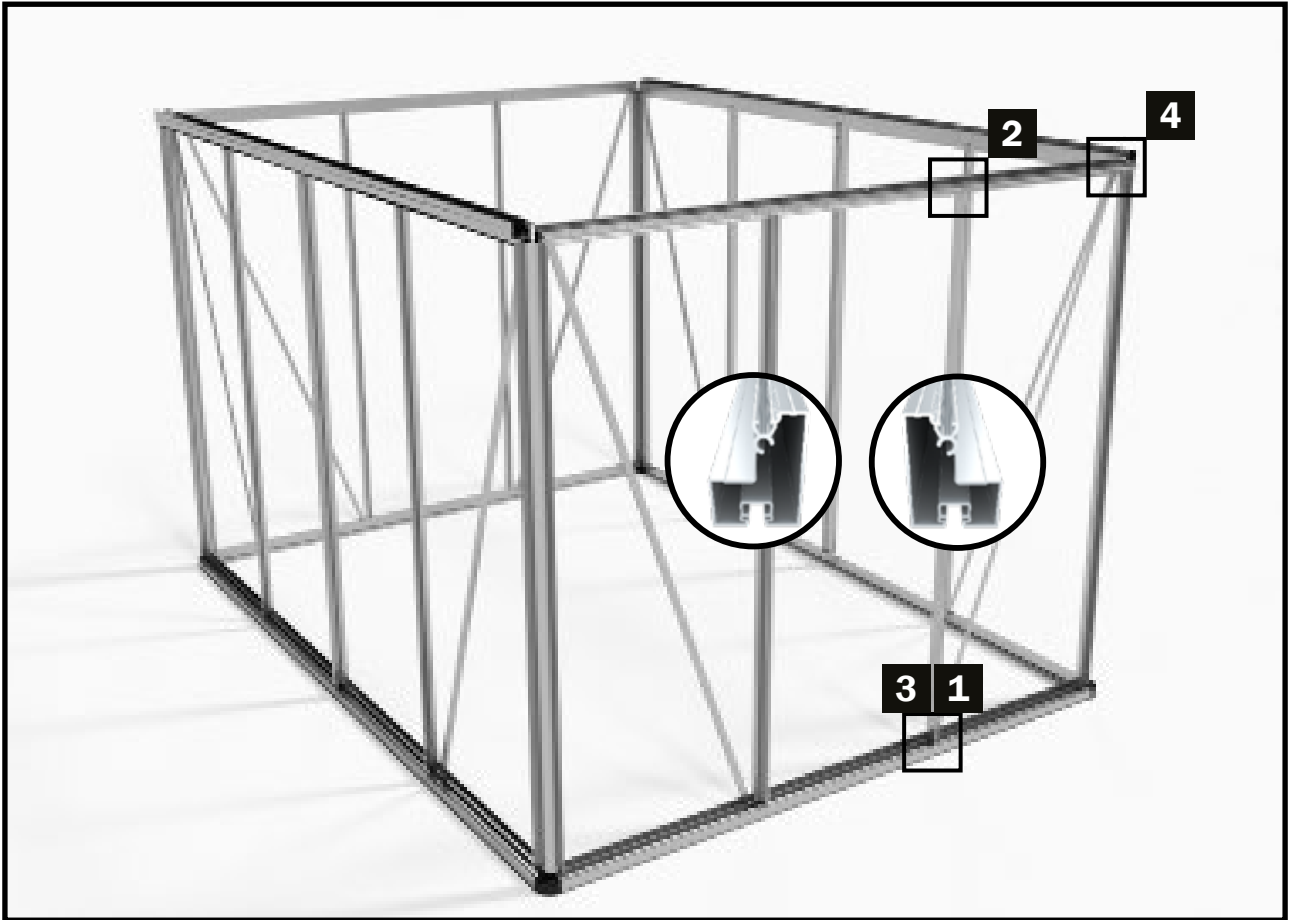

STEP 8 – Door frame profiles

In the following assembly phase, the door entrance profiles, together with the two wind bracings, are installed on the front wall.

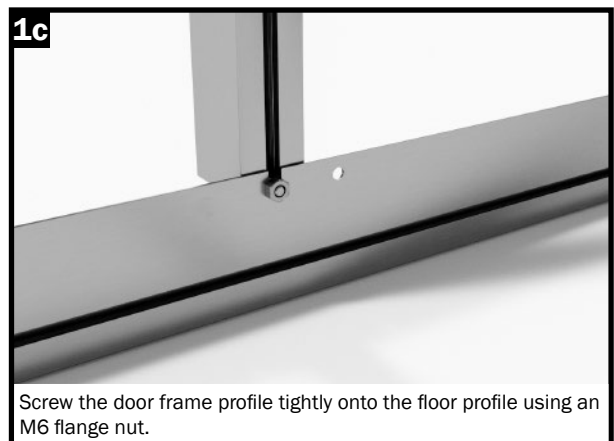
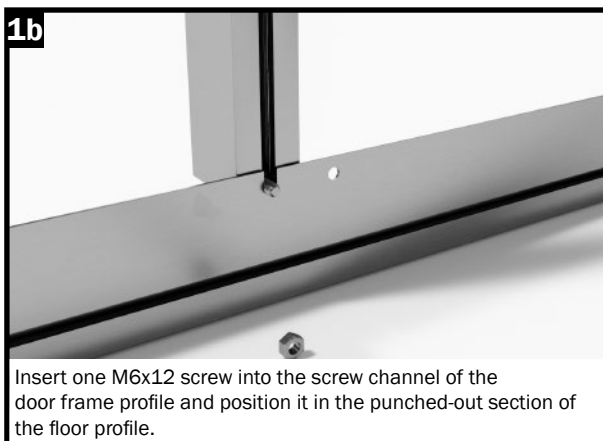
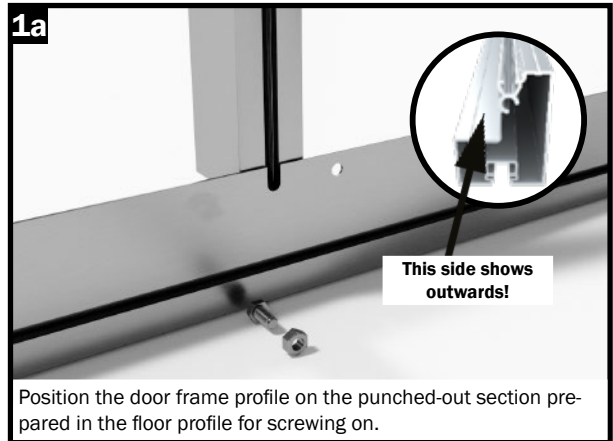

Step 8 – Door frame profiles

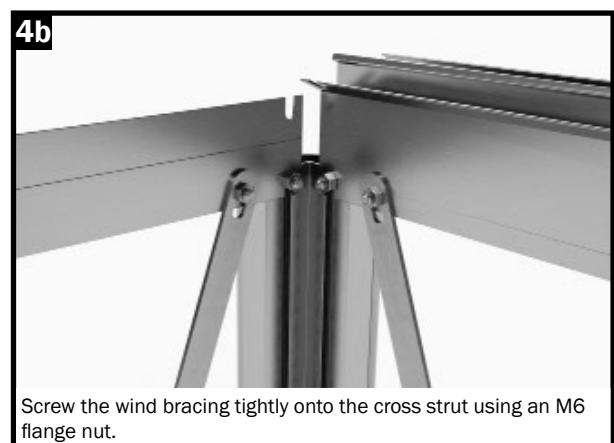
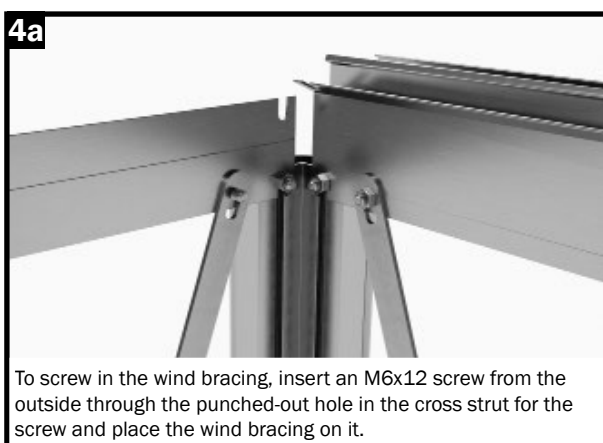
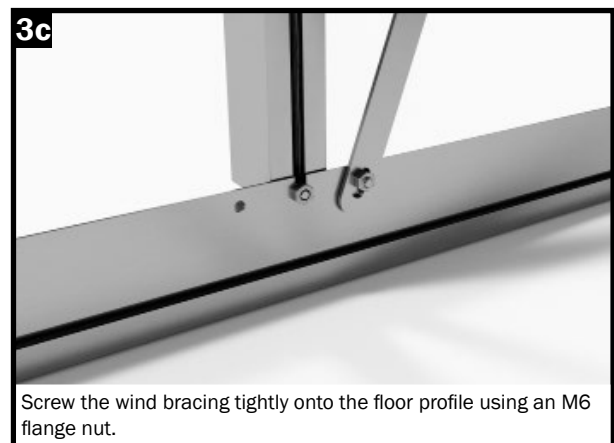
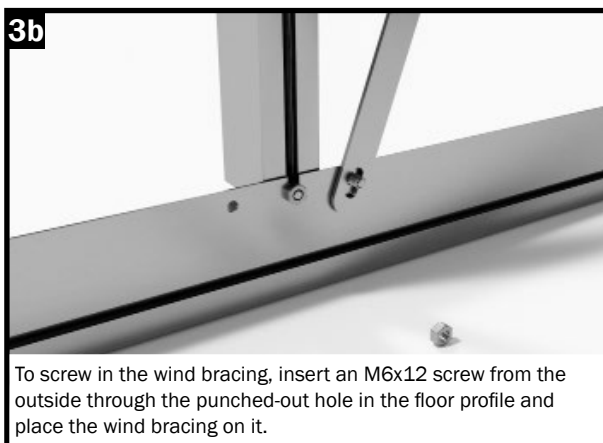
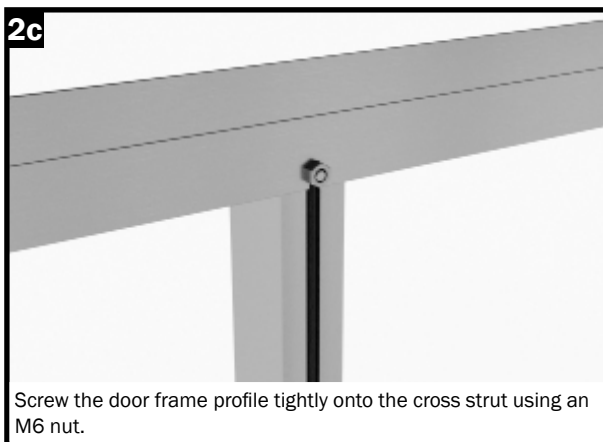
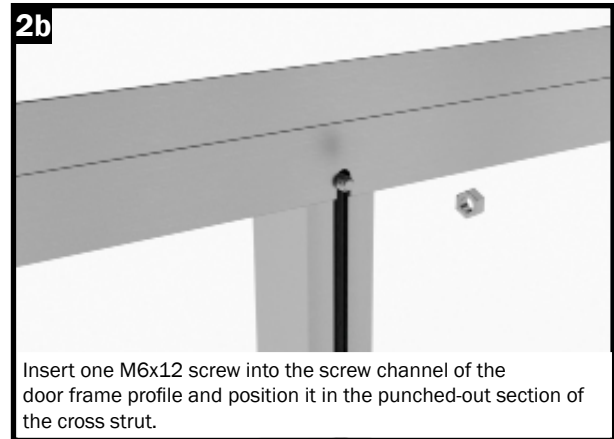

Step 9 – Roof support and gable corner profiles

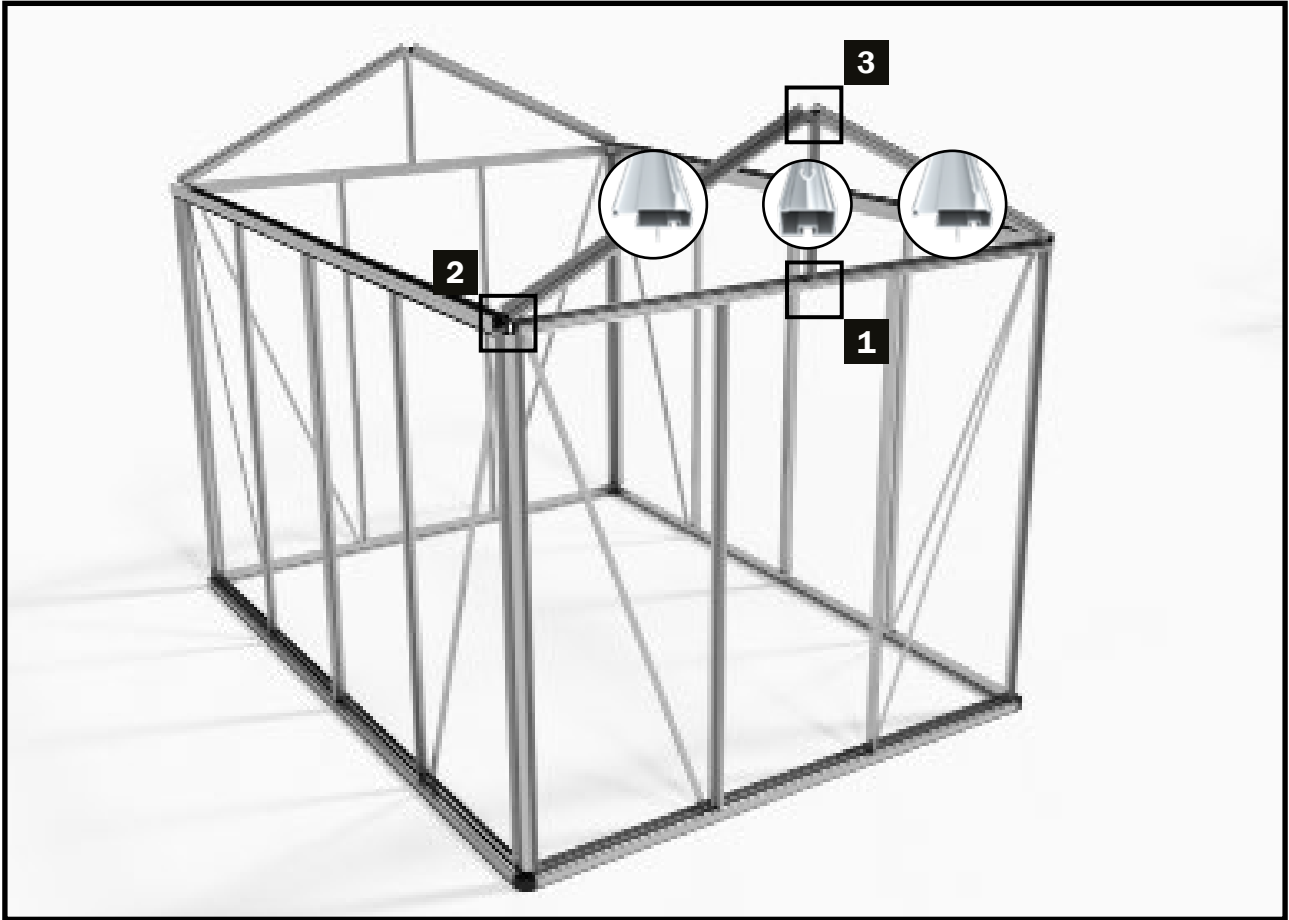

STEP 9 – Roof corner profiles

In the following assembly phase, the gable corner profiles, as well as the roof supports, are installed.

Note:

For assembling the roof corner profiles, seek help from a second person!

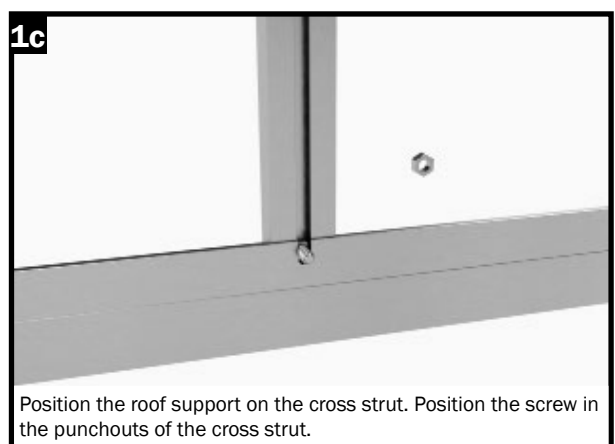
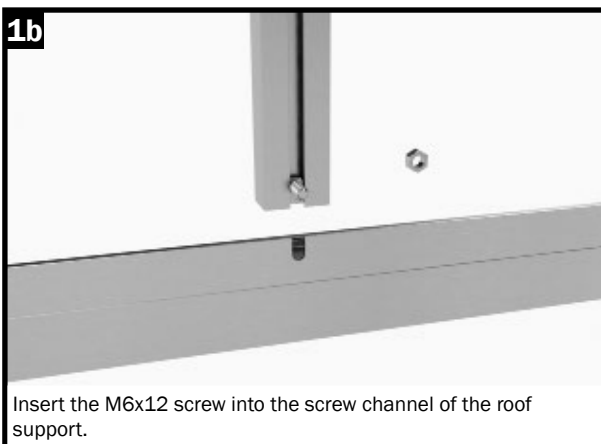
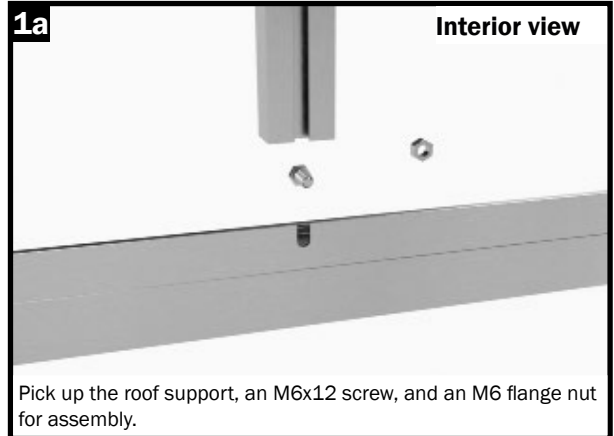

Step 9 – Roof support and gable corner profiles

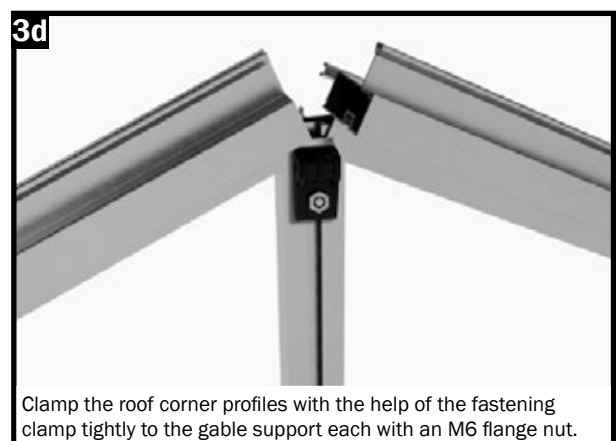
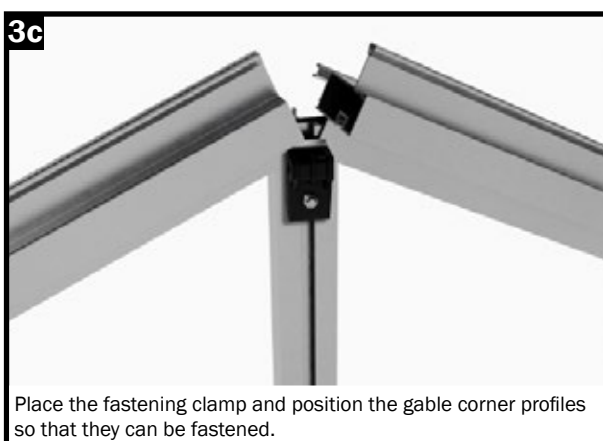
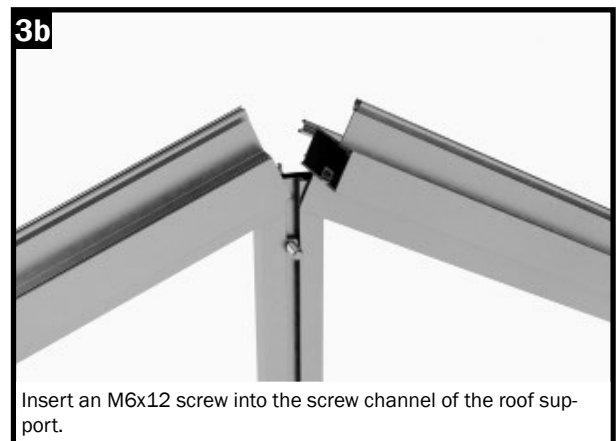
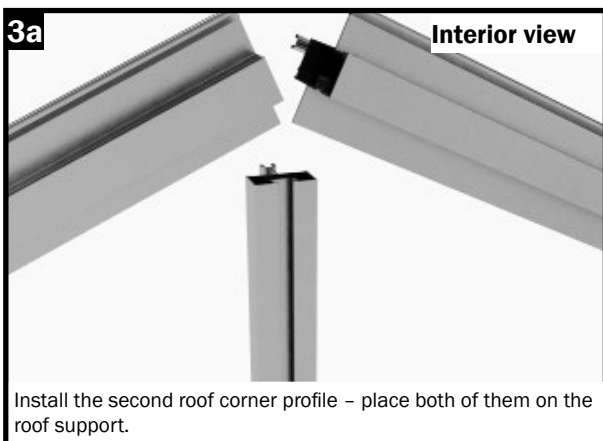
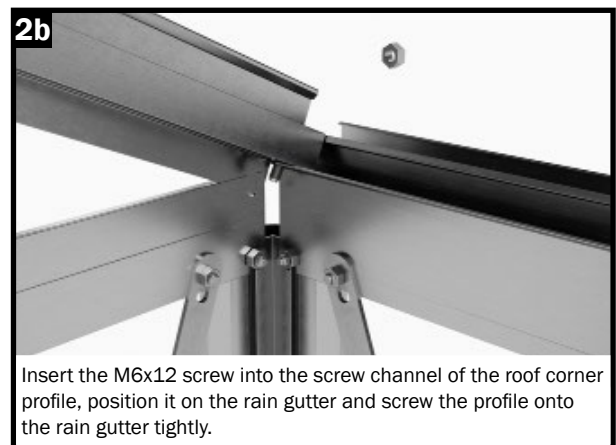
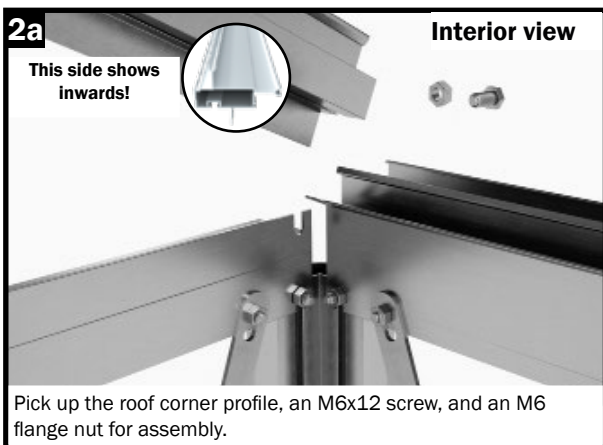
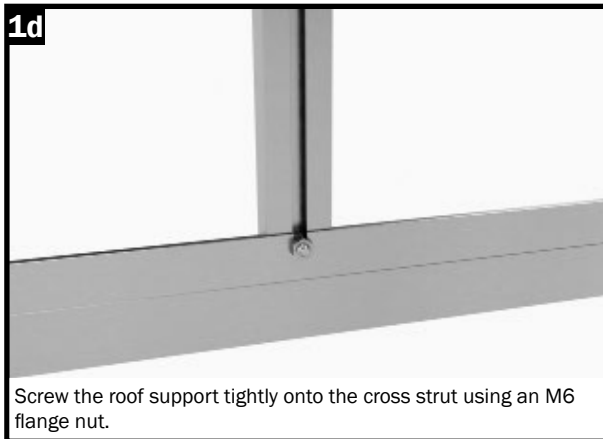

Step 10 - Ridge

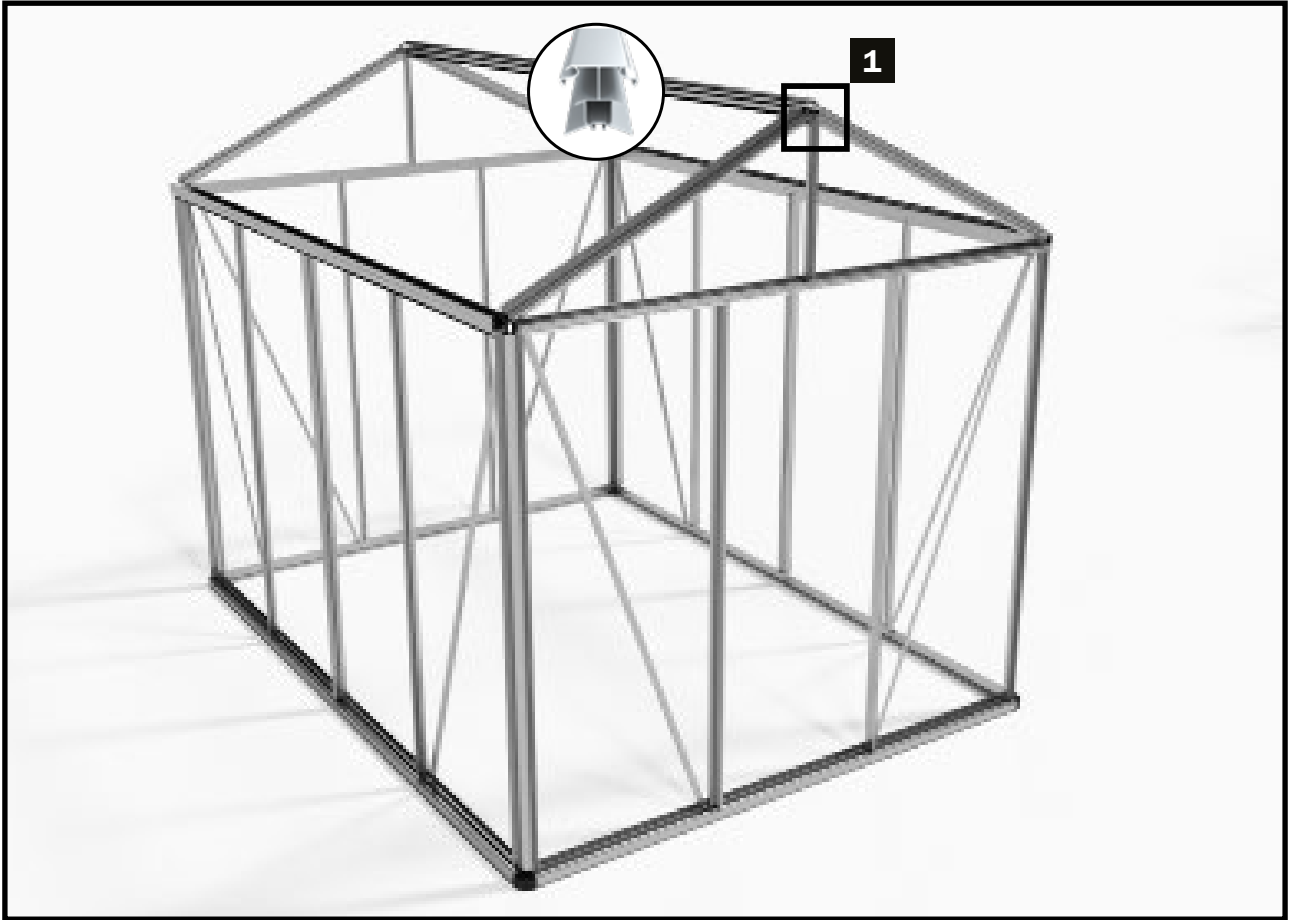

Step 11 – Assembling the roof struts

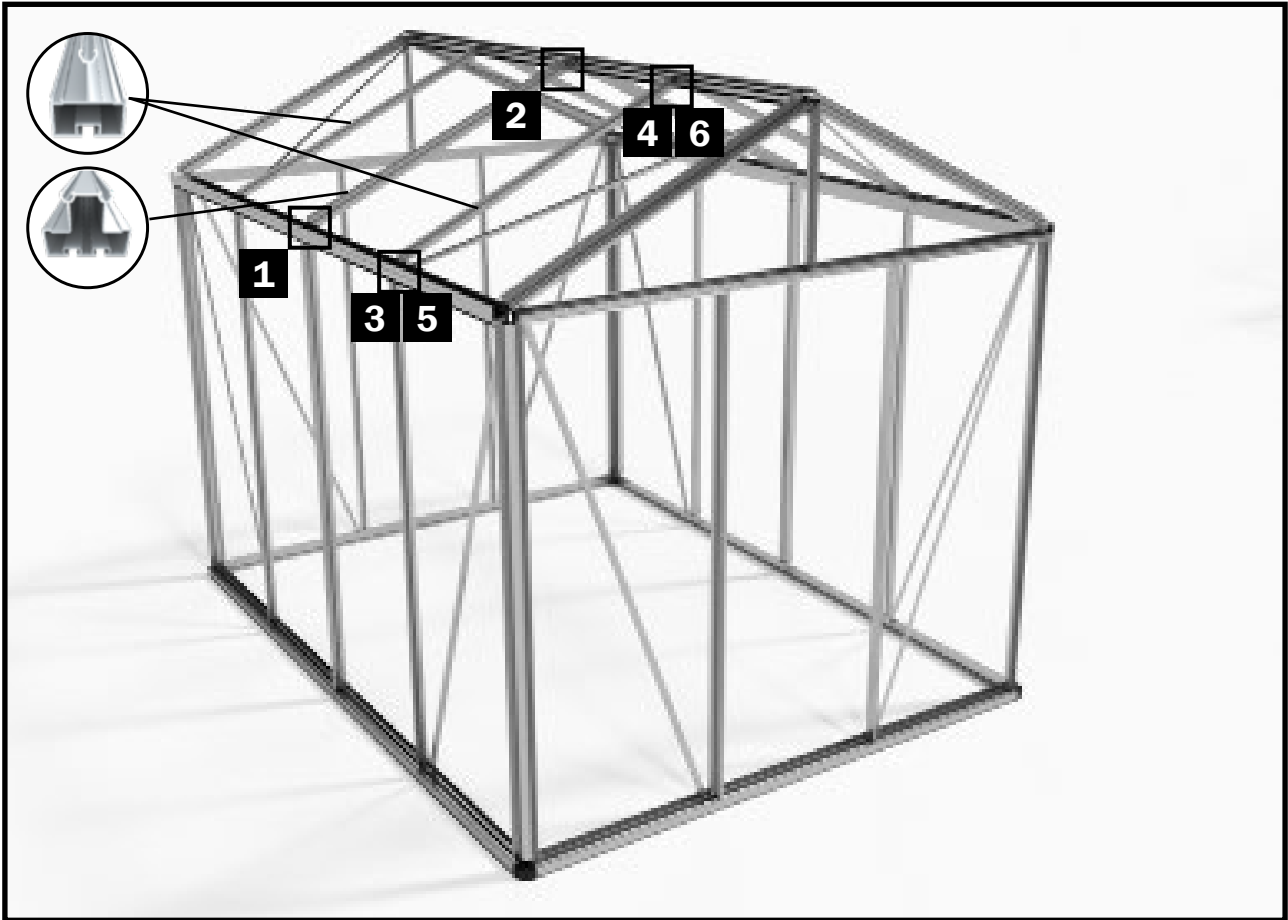

Step 11 – Assembling the roof struts

In the following assembly phase, the struts are installed on the roof surfaces.

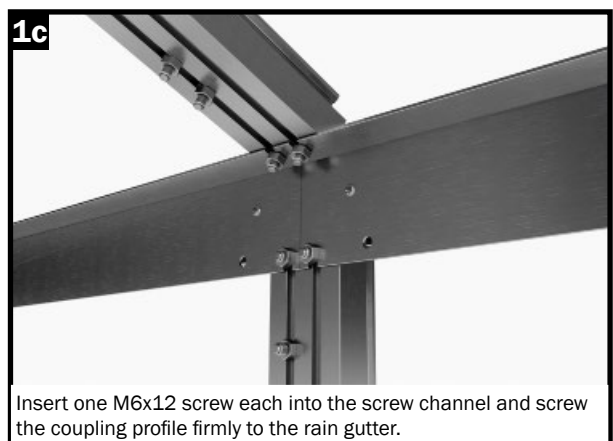
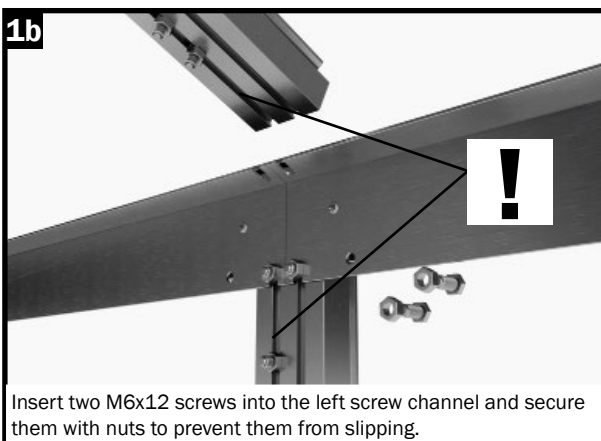

Step 11 – Assembling the roof struts

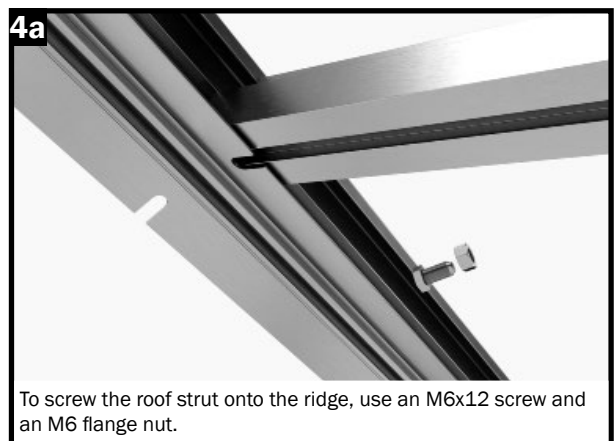

Step 11 – Assembling the roof struts

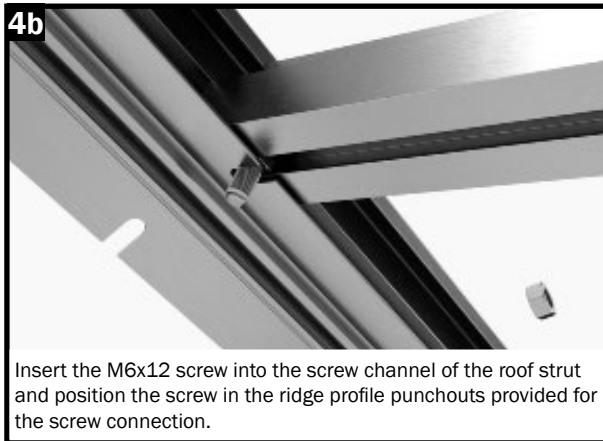

Step 11 – Assembling the gusset plates (reinforcement of ridge, eaves)

Step 11a – Assembling the gusset plates

To further improve the roof loads of our greenhouses, we have added additional gusset plates to the joints of the longitudinal profiles (ridge profile and rain gutter).

Please install one gusset plate each on the ridge partition and one on each of the two rain gutters. Please pay attention to the difference in the angles of the gusset plates at the ridge versus the rain gutter!

(The ridge gusset plate has one punched-out hole, the rain gutter gusset plate has two punched-out holes)

Tip:

To achieve the best stability, we recommend that you slightly span the ridge outwards with a support before installing the gusset plate onto the ridge.

When installing the gusset plates onto the rain gutters, please make sure that they are aligned exactly straight and under no circumstances bend outwards!

It is best to remove the support of the ridge only after the greenhouse has been glazed!

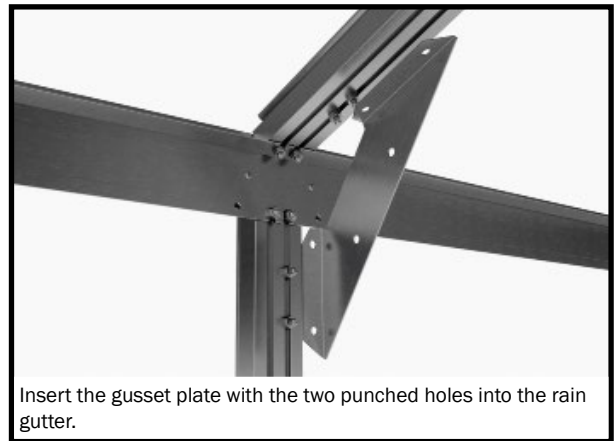
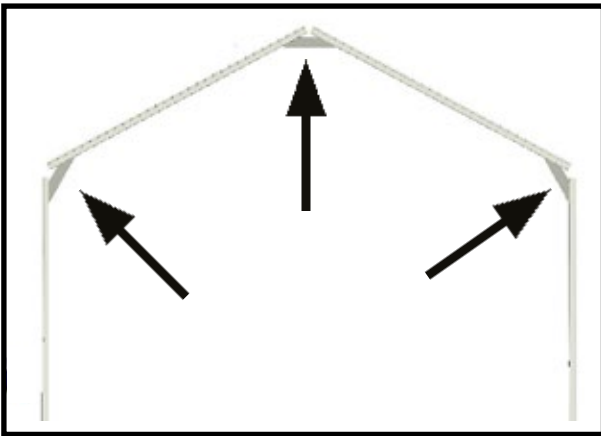

Insert the gusset plate with the two punched holes into the rain gutter.

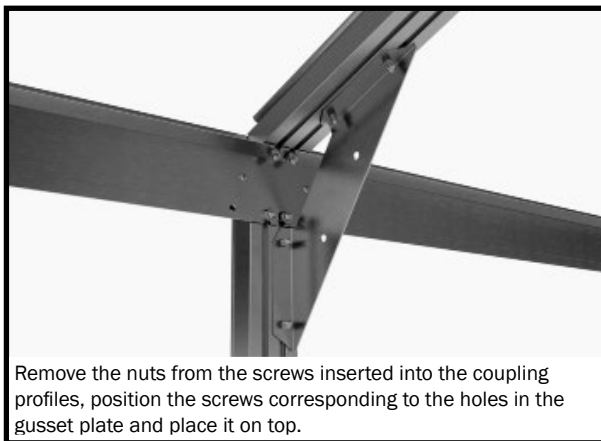

Remove the nuts from the screws inserted into the coupling profiles, position the screws corresponding to the holes in the gusset plate and place it on top.

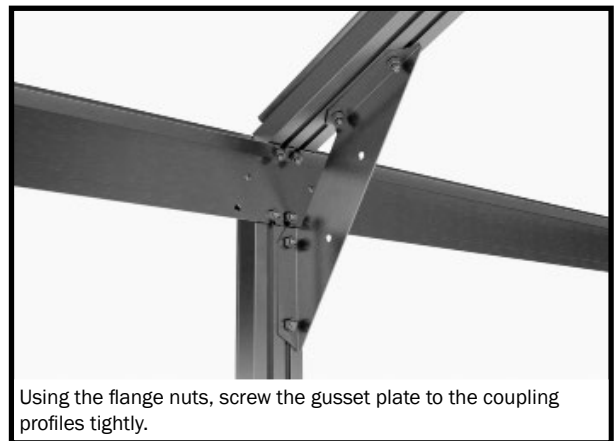

Using the flange nuts, screw the gusset plate to the coupling profiles tightly.



Proceed immediately with the gusset plate of the ridge – loosen the nuts, attach the gusset plate...

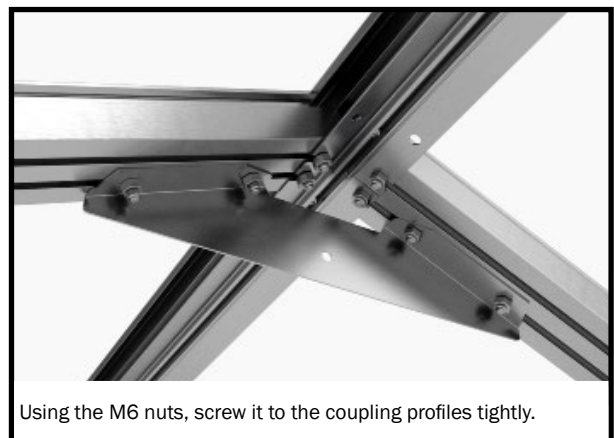

Using the M6 nuts, screw it to the coupling profiles tightly.

Step 12 – Inserting the twin-wall sheets

STEP 12 – Inserting the twin-wall sheets

In the following steps, the twin-wall sheets of your greenhouse are inserted into the prepared aluminium frame.

BEFORE ASSEMBLY:

Note that the glazing sheets have an inside and outside. The outside is UV-resistant and is marked with the inscription "OUTSIDE".

Alternatively, a film may have been applied to the sheets – the side with the film is the outer side.

The rubber seal must be fitted to the correct length.

Please use a sharp carpet knife for this purpose.

In cold temperatures, we recommend storing the rubber seal in a warm place before processing, as the rubber will therefore be more flexible and assembly will be easier.

NOTE:

Cover the top of the twin-wall sheet with the aluminium adhesive tape included in delivery. This prevents insects from getting trapped in the twin-wall sheets from above. We recommend not closing the underside of the twin-wall sheets with the adhesive tape, so that any condensation water that may occur can drain downwards!

WARNING!!

The supplied U-profiles are **also supplied in "natural aluminium"** with coloured models!

These are **only used at the bottom of the twin-wall sheets!**

The **gable sheets** do not get a U-profile!

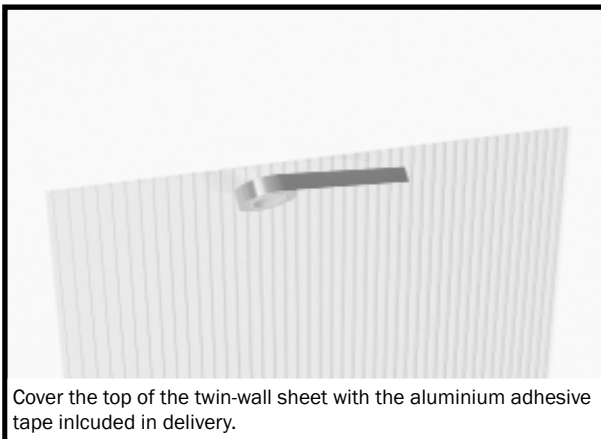

Cover the top of the twin-wall sheet with the aluminium adhesive tape included in delivery.

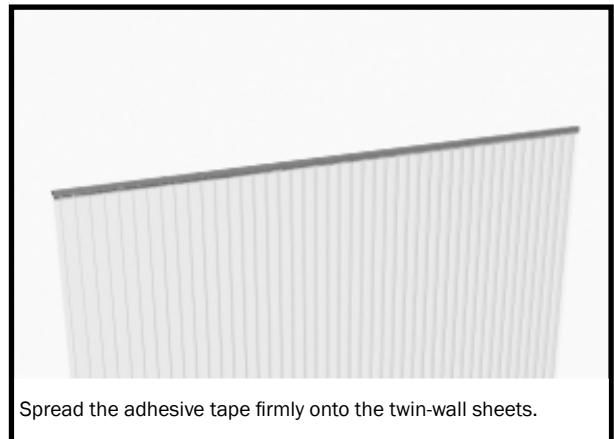

Spread the adhesive tape firmly onto the twin-wall sheets.

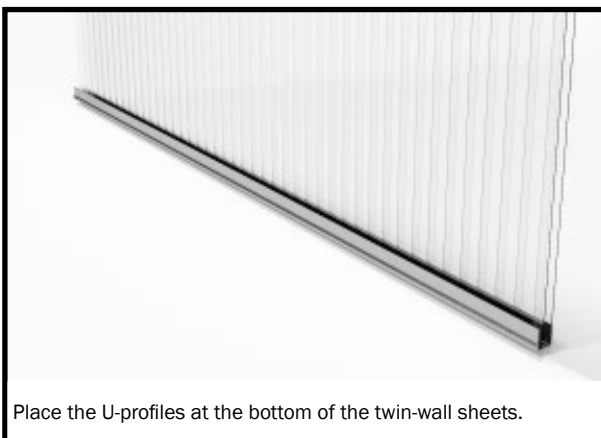

Place the U-profiles at the bottom of the twin-wall sheets.

NOTE:

For the roof and side wall panels, the U-profiles are placed in different directions!

For the roof panels, the "fastening lip" on the U-profile should point towards the inside of the panel, for the side wall panels towards the outside.

We recommend that the U-profiles only be placed on the individual panels immediately before insertion, so that they are not incorrectly attached.

Step 12 – Inserting the twin-wall sheets

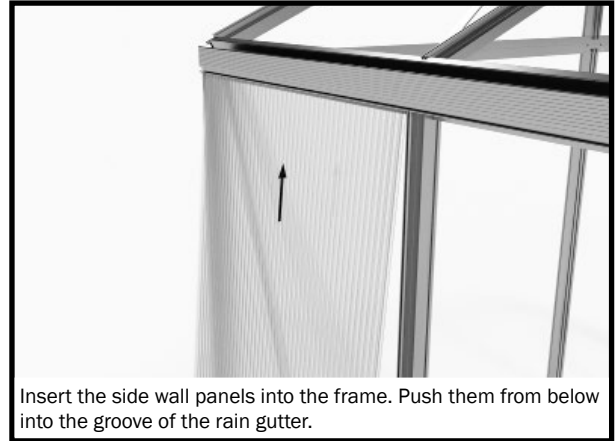

Insert the side wall panels into the frame. Push them from below into the groove of the rain gutter.

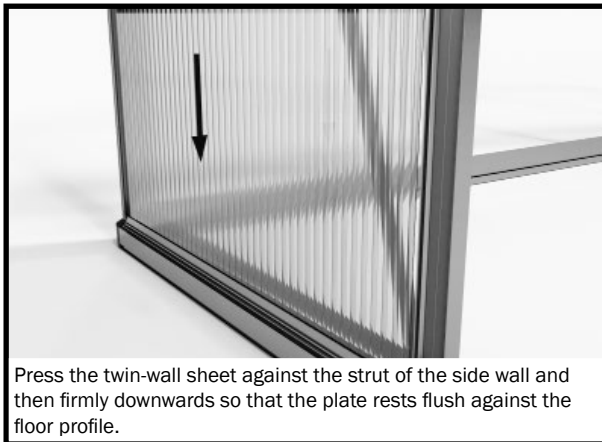

Press the twin-wall sheet against the strut of the side wall and then firmly downwards so that the plate rests flush against the floor profile.



Make sure that the "fastening lip" of the U-profile is pointing outwards.

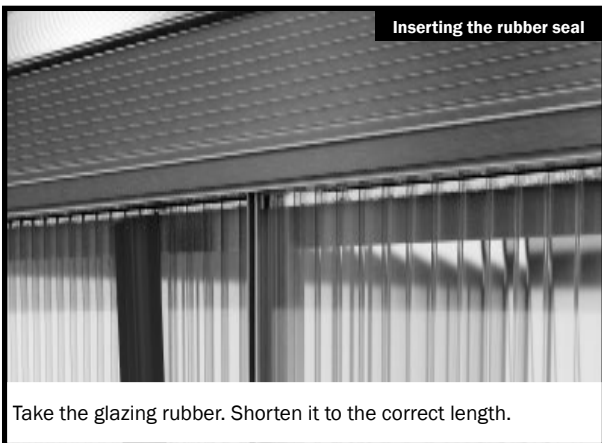

Take the glazing rubber. Shorten it to the correct length.



Press the rubber seal firmly against the strut until it snaps into place and holds the strut firmly.

Glaze the side walls and the roof in the same way.

Note on twin-wall roof sheets:

When glazing the roof, you need to decide in advance where the skylights will be situated. For these panels, you will only glaze the roof halfway to the ridge.

We recommend installing the window openings on the weather side facing away from the wind, if possible.

Note that two skylights cannot be positioned directly next to each other!

Step 12 – Inserting the twin-wall sheets

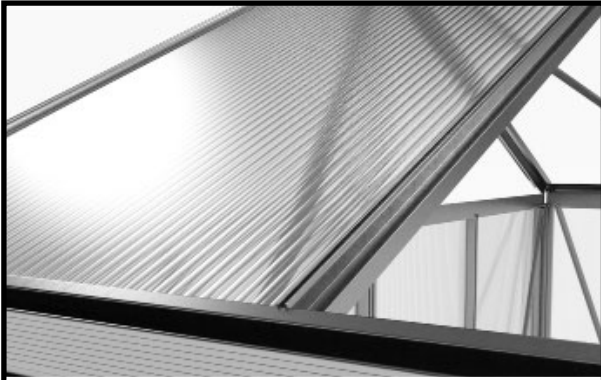

Insert the roof panels or sheets under the skylights into the roof surface sections.

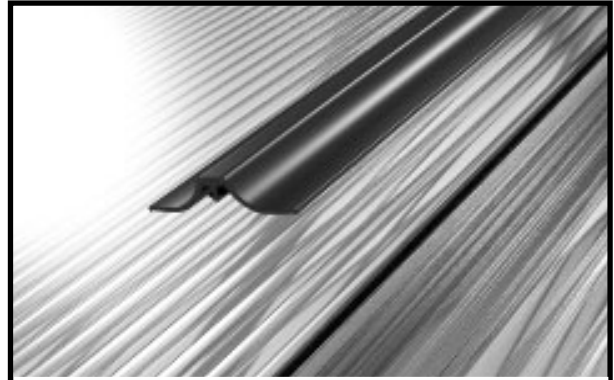

Take a rubber seal and shorten it to the appropriate length.

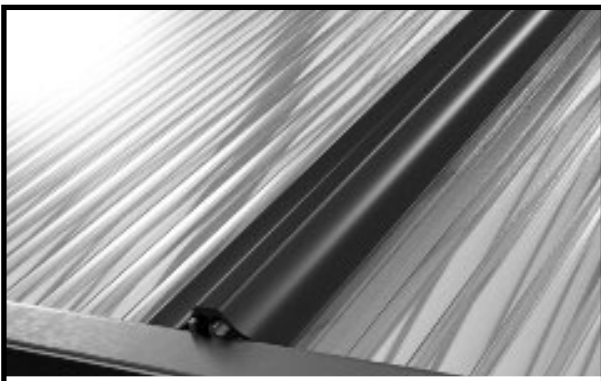

Press the rubber seal firmly into the strut until its hooks snap into the profile thus holding the rubber seal firmly.



Inserting the gable triangles

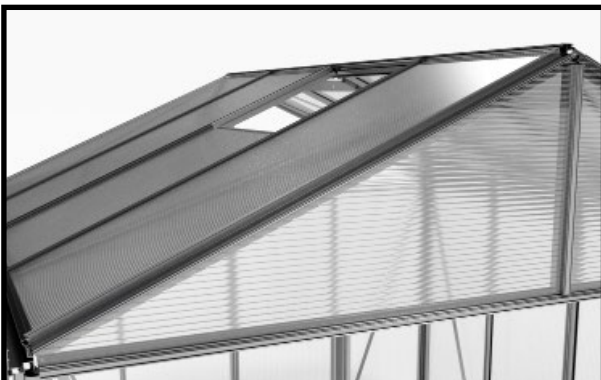

Insert the twin-wall sheets of the gable corners into the frame.

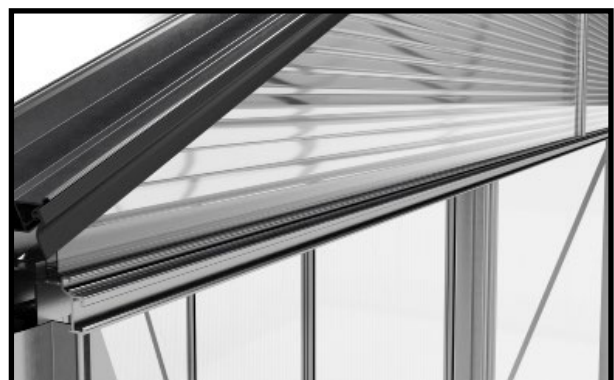

Install the half rubbers on the roof corner profiles to hold the top panel to the frame.



Triangular gable plates

Attach the rubber to the gable supports.



Install the half rubber on the cross strut - this allows the gable sheets to be held together with rubber seals all around.

Step 13 – Window stop

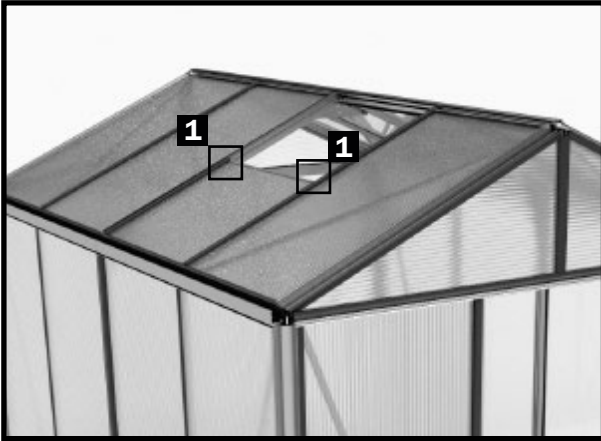

STEP 13 - WINDOW STOP

In the following phase of assembly the window stop profile is mounted at each of the roof panels where a window is to be fixed.

Note:

An M6/12 rhombus screw (no. 690622) is used for assembling each window stop profile on each roof strut!

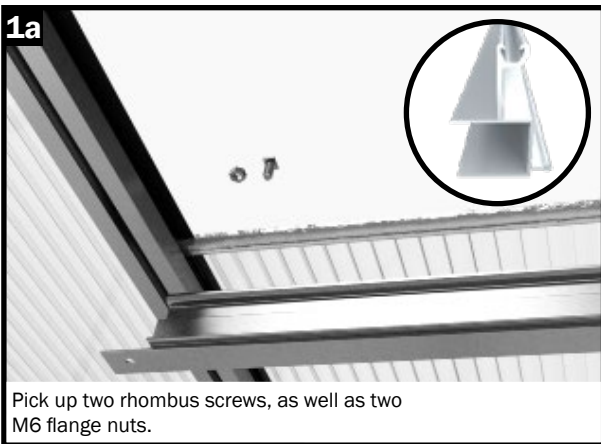

Pick up two rhombus screws, as well as two M6 flange nuts.



Insert an M6x12 mm rhombus screw into the screw channel of the roof strut on each side.

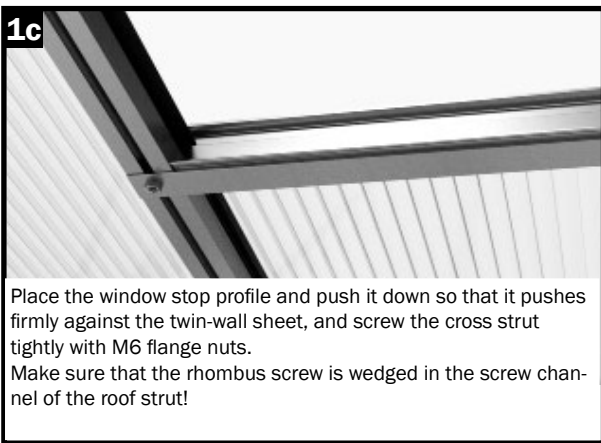

Place the window stop profile and push it down so that it pushes firmly against the twin-wall sheet, and screw the cross strut tightly with M6 flange nuts.
Make sure that the rhombus screw is wedged in the screw channel of the roof strut!

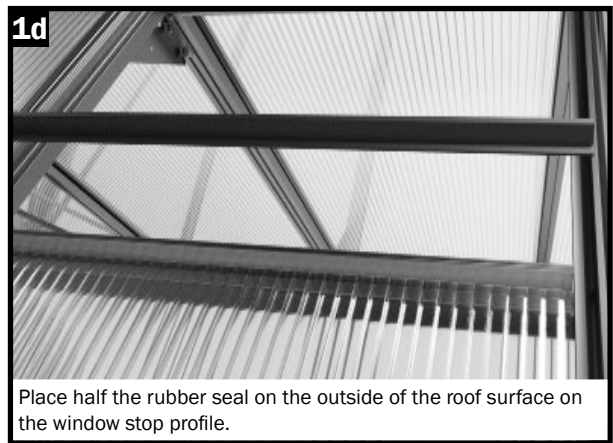

Place half the rubber seal on the outside of the roof surface on the window stop profile.



This also closes the top side of the "half" roof panel.

Automatic window opener

The installation of an automatic skylight opener is recommended as a useful accessory. This ensures carefree and optimal ventilation of your greenhouse. It protects your valuable plants from heat accumulation inside the greenhouse. The temperature is adjustable and it works without electricity.

The clasp included in the delivery contents is simply exchanged for the automatic opener.

IMPORTANT: In winter, the automatic window opener needs to be protected from frost. Replacing the automatic window opener with the manual window stay is recommended!

Step 14 – Window assembly and installation

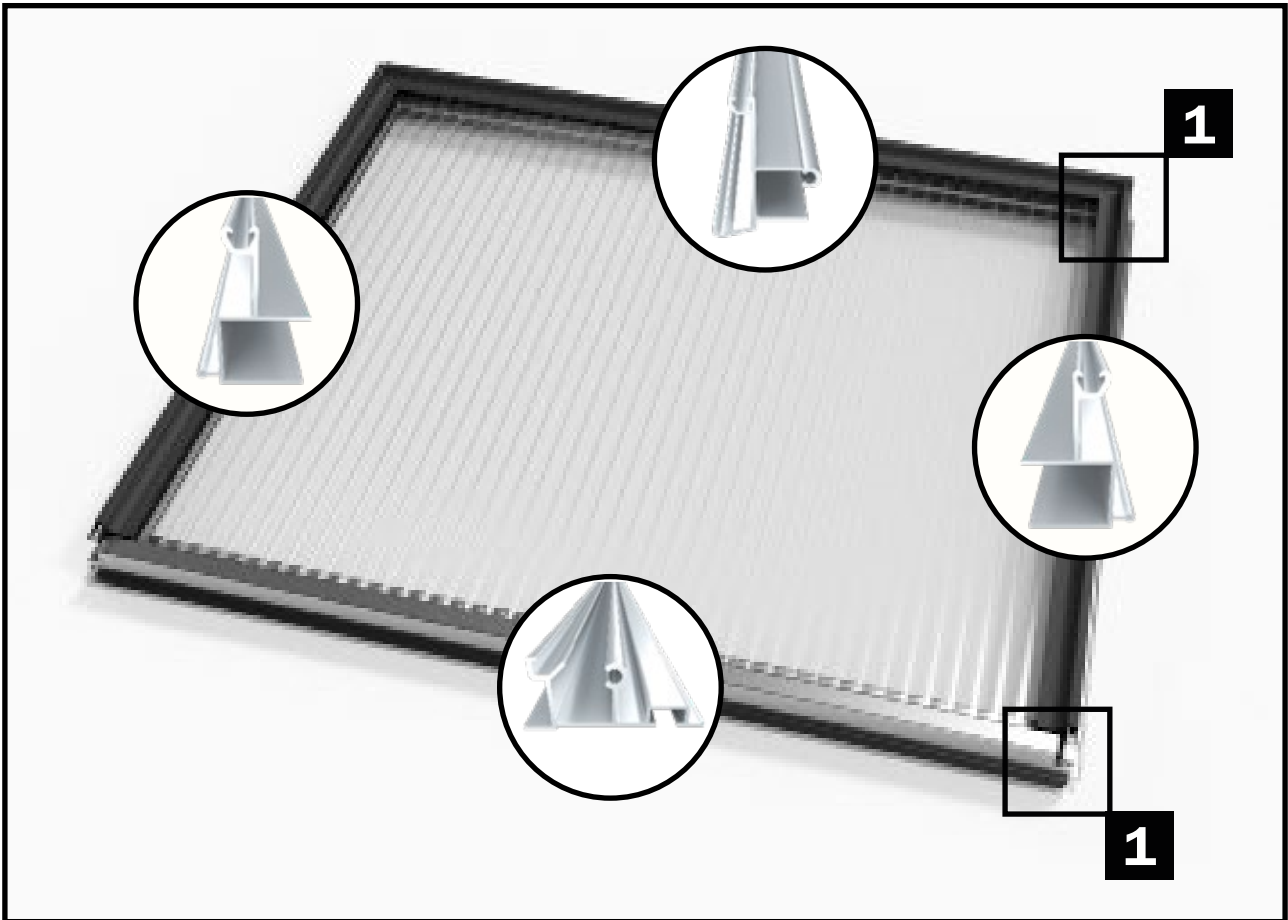

STEP 14 – Assembling and installing the window

The window is assembled in the following phase of assembly.

Note: The M6/12 screws shown in Figure 1a are only needed once and therefore only inserted into the screw channel on one side.

After assembly, the window is pushed into the ridge. **IMPORTANT:** Push the window from the end of the ridge profiles to the desired location.

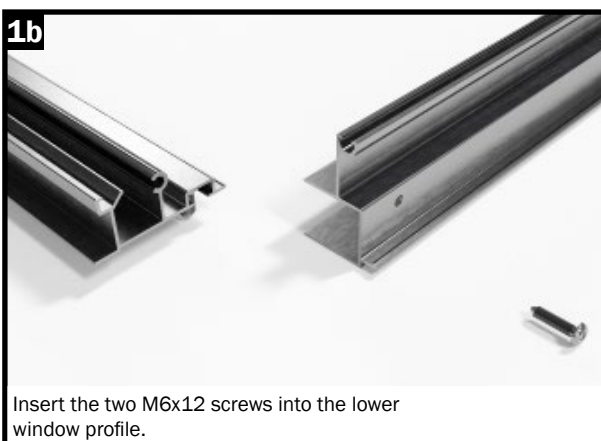
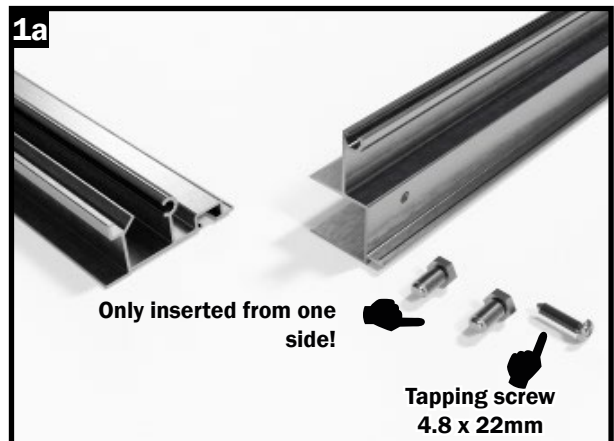

Insert the two M6x12 screws into the lower window profile.



Fix the side window profile onto the lower window profile and screw it on with the 4.8 x 22 mm tapping screw.

Step 14 – Window assembly and installation

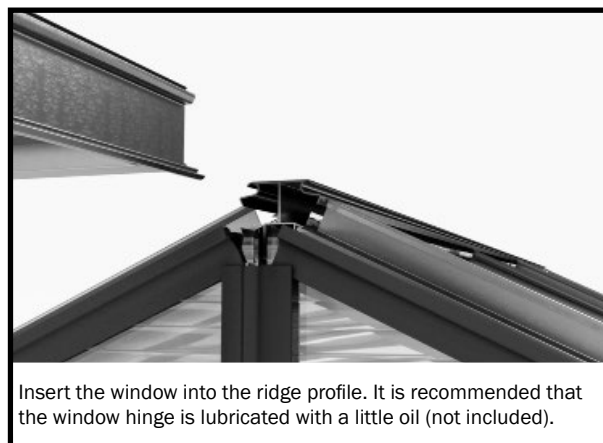
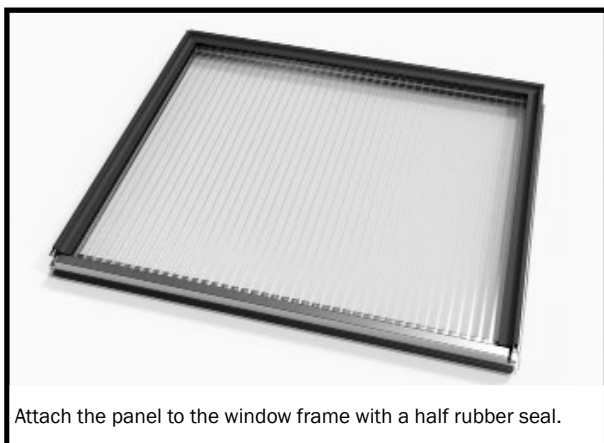
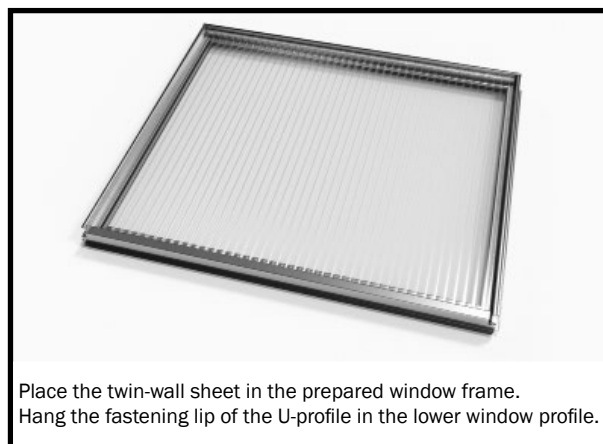
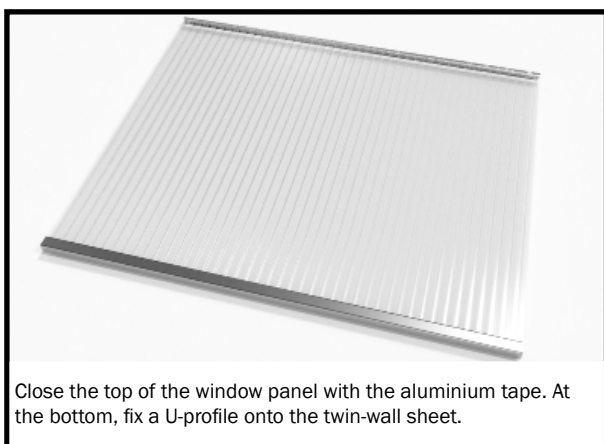

Step 14 – Window assembly and installation

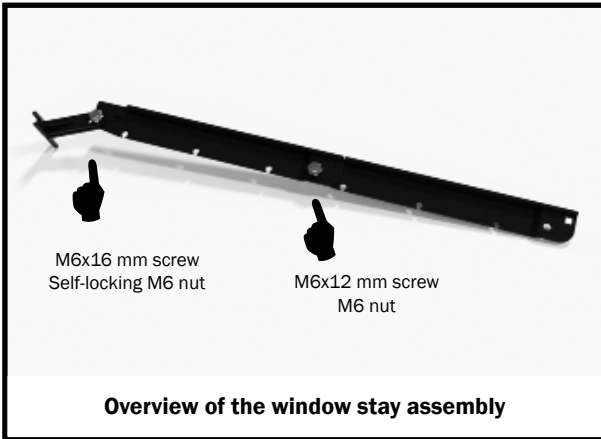

Step 15 - Installing the door rails above and below

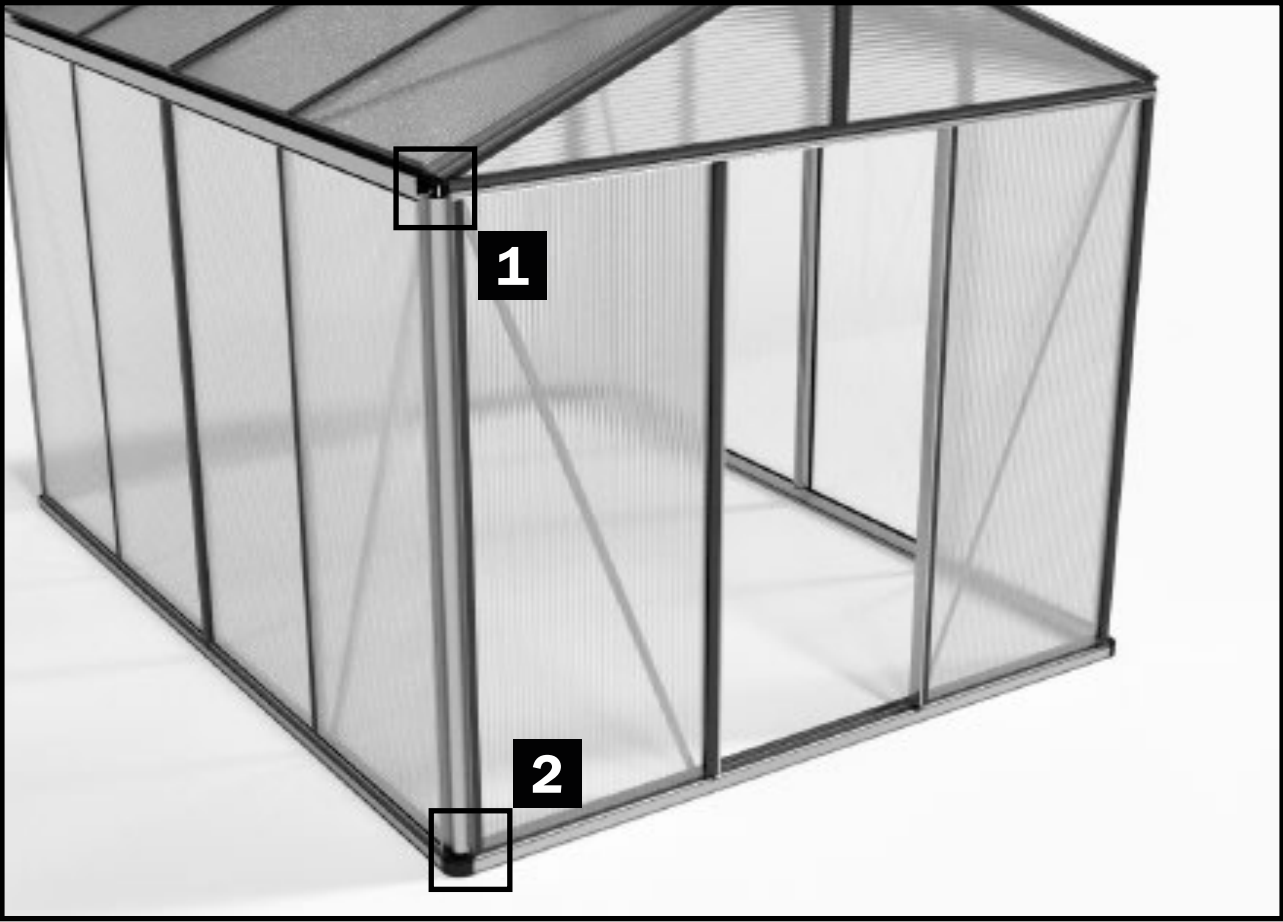

STEP 15 - Installing the door rail/installing the door

The door is mounted in the following phase of assembly.

Step 15 – Installing the door rails above and below

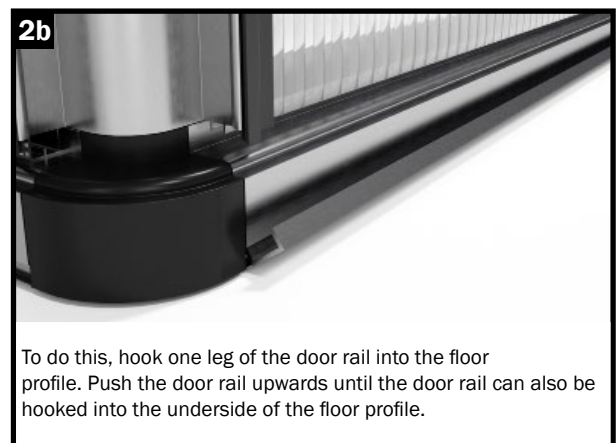
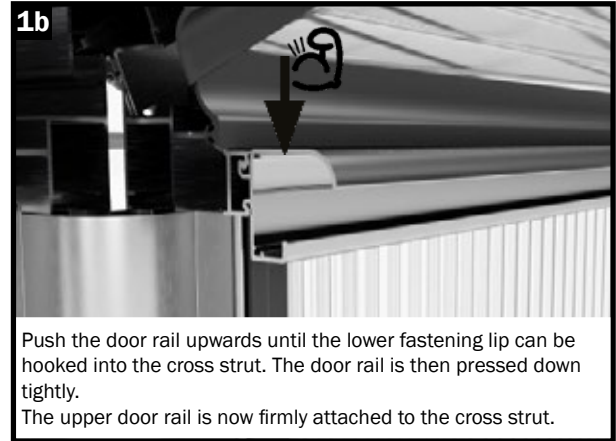

Step 16 – Assembling and installing the door

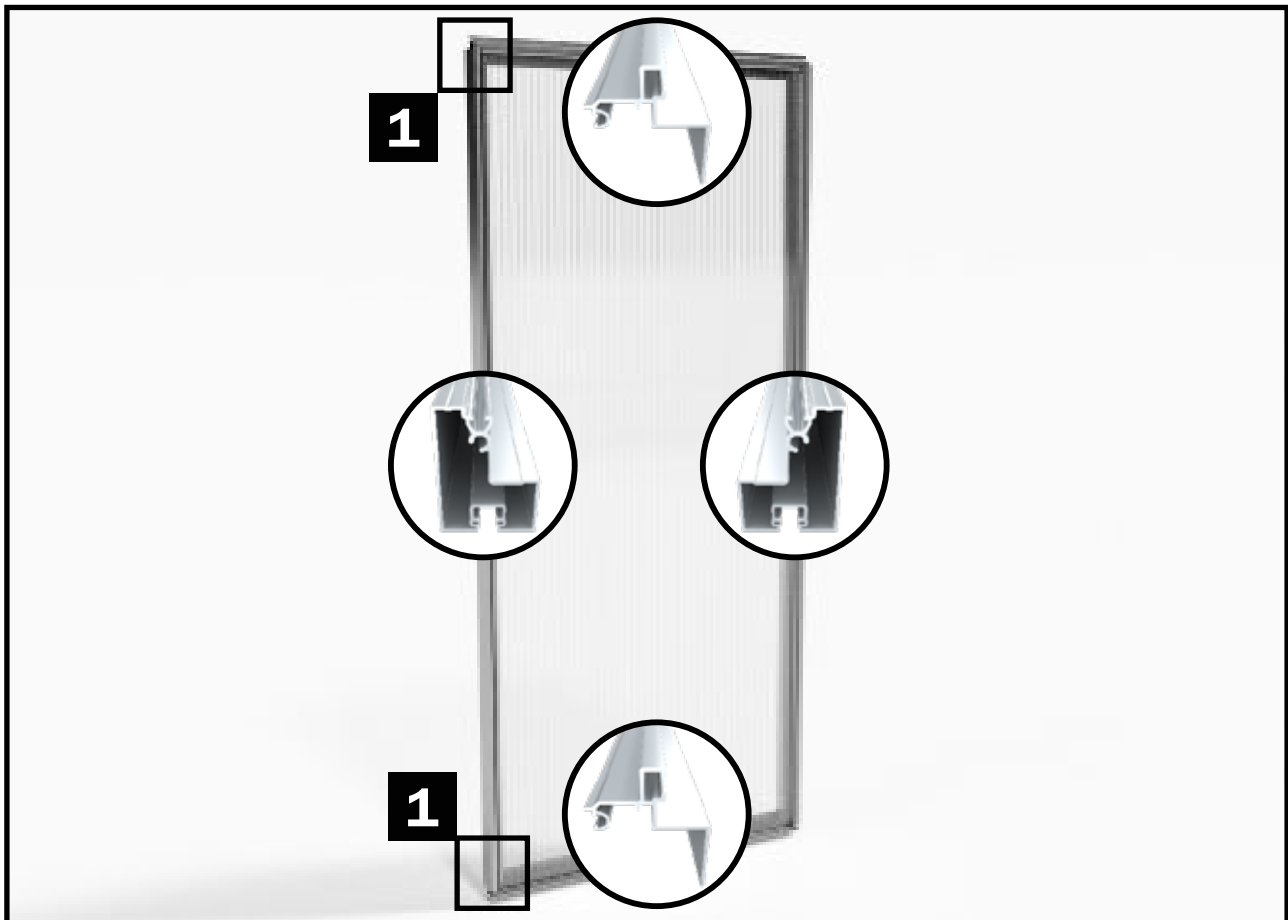

IMPORTANT NOTE

M6 nuts without flange are used when assembling the doors!

The M6 nuts without flange are used as follows:

- At the four corners of each door element
- When screwing the axle bolts
- When fixing the door handles inside

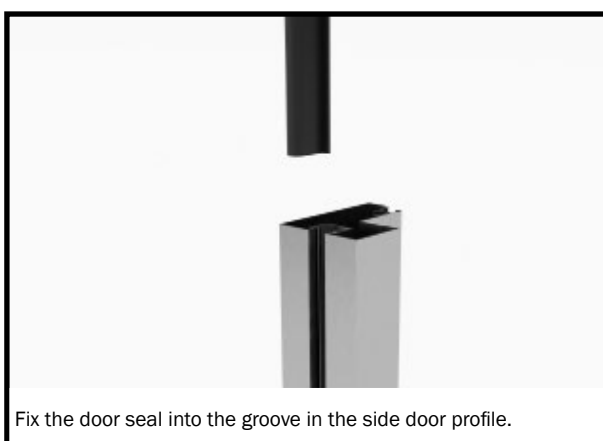

Step 16 – Assembling and installing the door

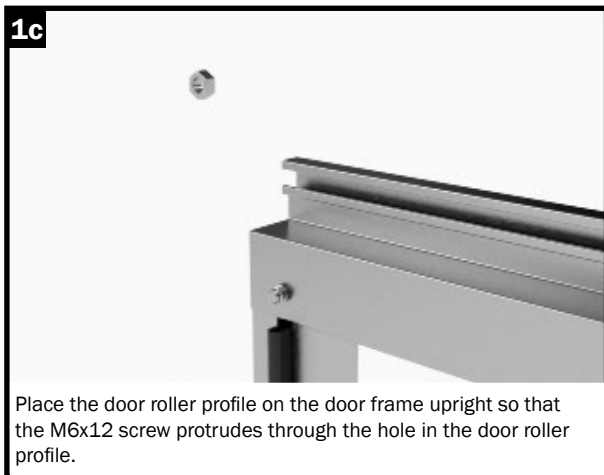
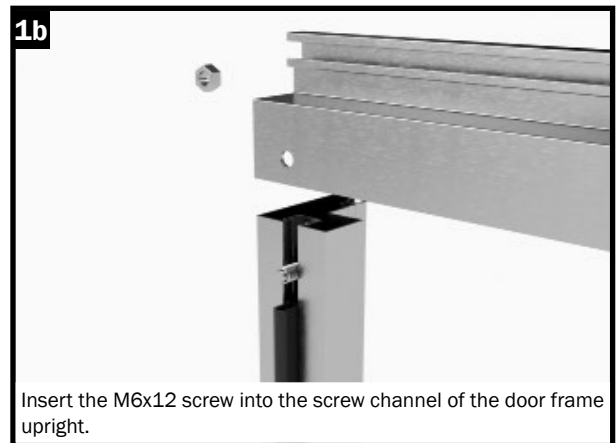
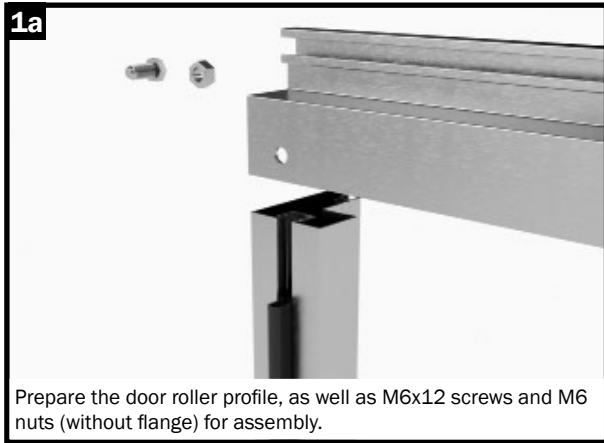

Step 16 – Assembling and installing the door



Place the twin-wall sheet into the prepared door frame. Attach the twin-wall sheet on all four sides of the door frame with the half rubber seal.

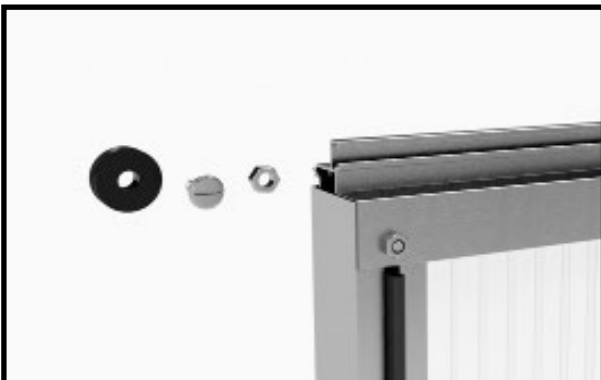

Prepare the door rollers, axle bolts and M6 nuts for assembly.

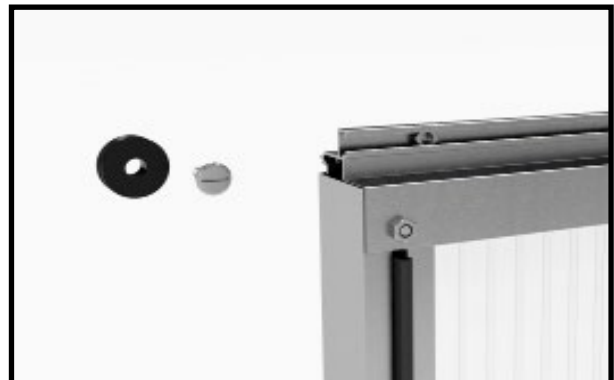

Put the nut into the door roller profile.

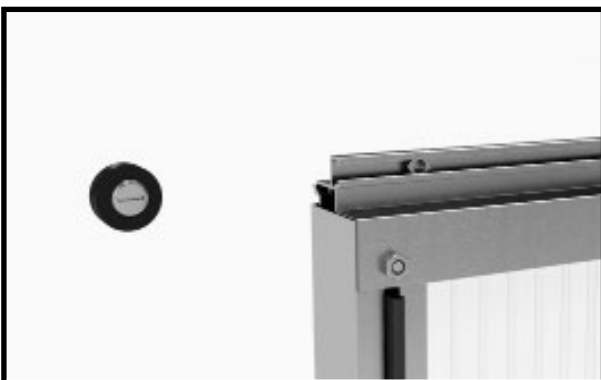

Fix the axle pin onto the door roller.



Screw the axle pin to the nut.

We recommend positioning the door roller approximately 40 mm from the end of the door roller profile.

Step 16 – Assembling and installing the door

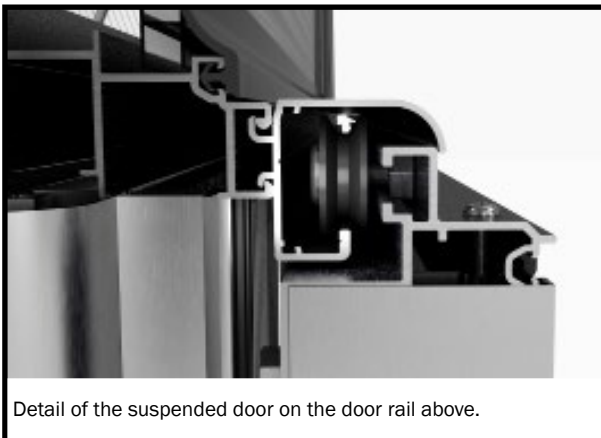
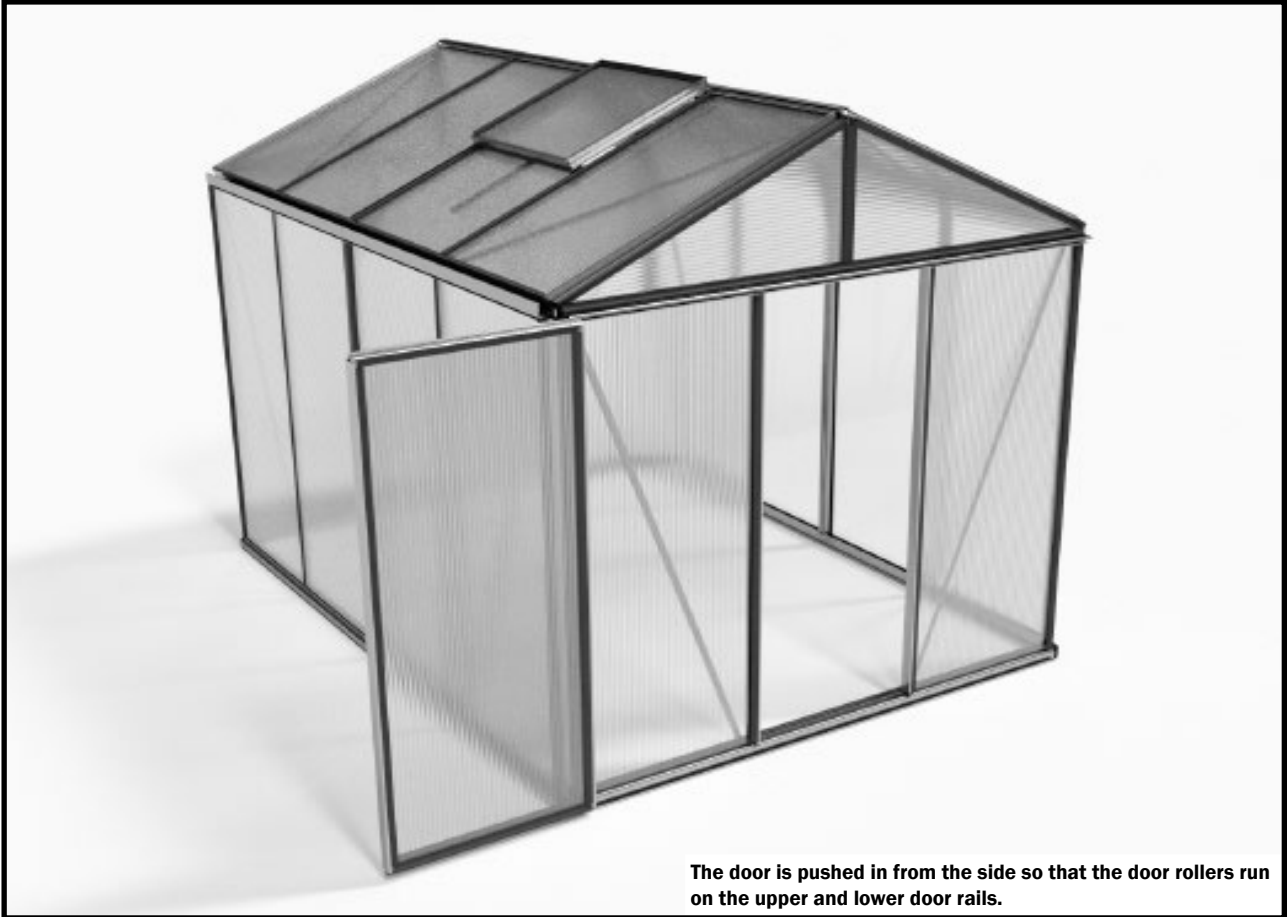

Step 16 – Assembling and installing the door

Installing the door handles

The installation of the door is completed after fixing the door handles inside and outside.

Note:

When installing the door handles on the outside, pre-drill, even though drilling screws are used.

Use a drill with a diameter of 4 mm.

Installation of the door handles on the inside is carried out with rhombus screws.



Start with the outer door handles.
Pre-drill holes with a 4 mm drill bit.



Place the door handles in the pre-drilled position.

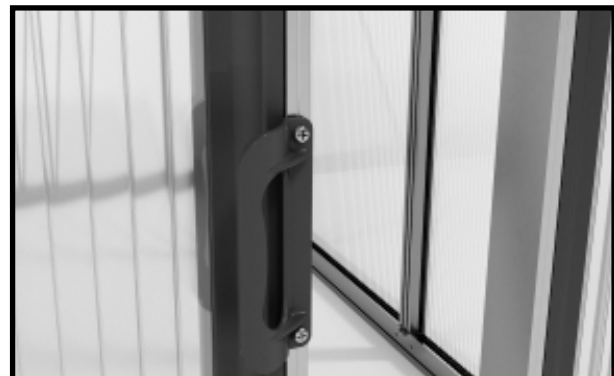

Screw the door handle with 4.8 x 13 mm drilling screws.

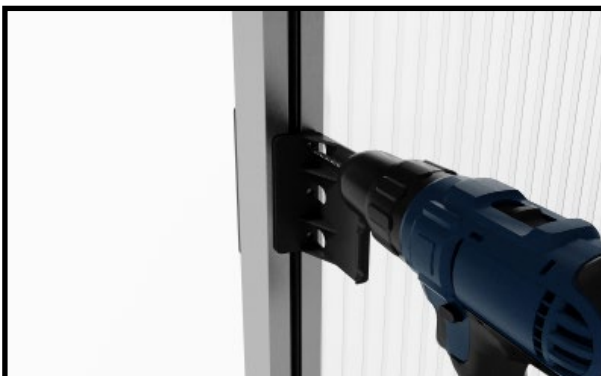

Now mount the inner door handles.
Pre-drill holes with a 4 mm drill bit.



Pick up the two door handles for the inside.

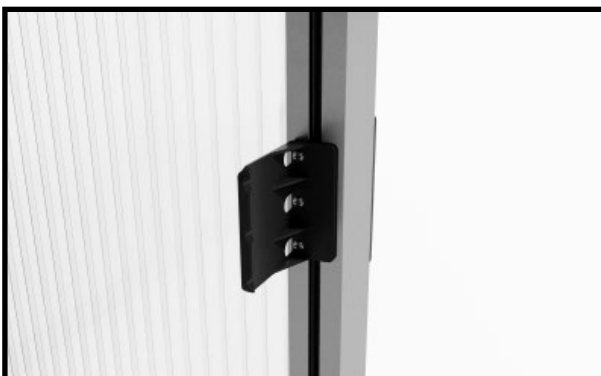

Screw the door handles with 4.8 x 13 mm drilling screws.

Step 17 – Final work

Finally the ridge cap covers and the left and right drain pipes need to be attached.

Note: The drain pipes are delivered closed – but they are formed in such a way that the centrepiece can be pushed gently with a screwdriver to drain the water.

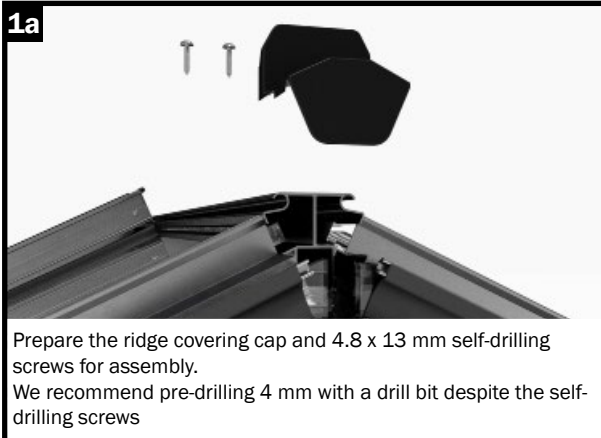
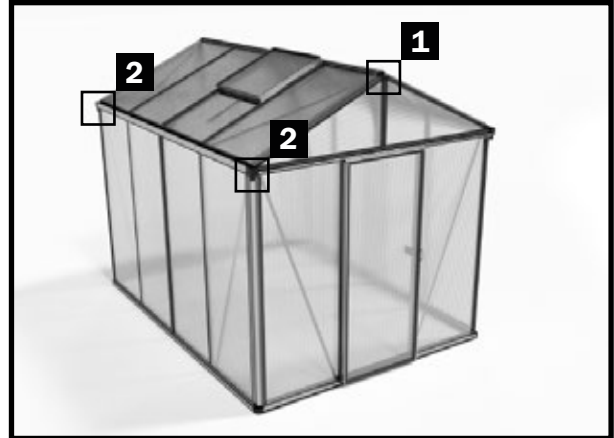

Prepare the ridge covering cap and 4.8 x 13 mm self-drilling screws for assembly. We recommend pre-drilling 4 mm with a drill bit despite the self-drilling screws

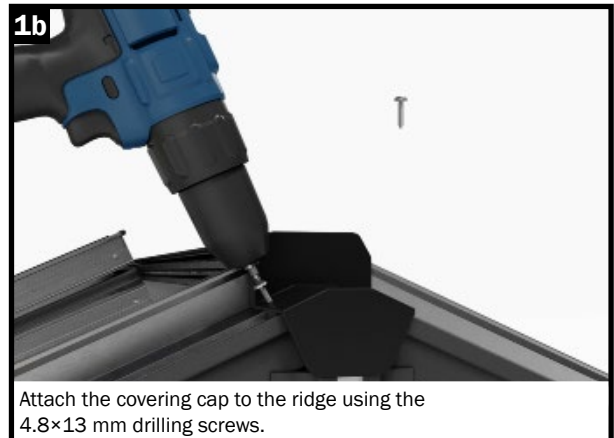

Attach the covering cap to the ridge using the 4.8x13 mm drilling screws.



Fix the left drain pipe into the rain gutter.



The drain pipe is now firmly attached. Repeat this step for all four corners.

Step 18 – Screwing on the struts and profiles

Step 18 – Screwing on the struts and profiles

In the final assembly step, the various struts and profiles are screwed on, which gives the product even better stability – **especially in the event of large storms.**

Note: Powder-coated profiles are so smooth that the frictional resistance decreases to such an extent that in the event of large storms, the M6x12 screws with the M6 flange nut mm cannot hold the construction together well enough.

In the event of a particularly huge storm, the profiles may be ripped out of the screw fitting.

In addition to the M6x12 screws and flange nuts, all struts are therefore screwed on with 4.8x13 mm drilling screws. In this way, the struts can in no way be ripped out of the screw fitting.

We recommend that these screw fittings **also be used with the natural aluminium version!**

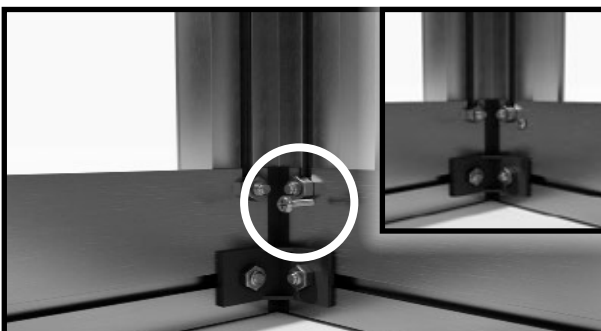

Start with the side corner profiles and the floor profiles. Screw the side corner profile and the floor profile with the 4.8x13 mm drilling screw.

Repeat this step for the other three corners.

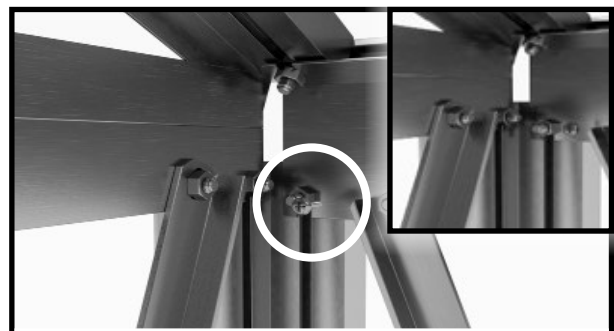

Continue with the rain gutter and the side corner profile. Screw the side corner profile and the rain gutter with the 4.8x13 mm drilling screw.

Repeat this step for the other three corners.

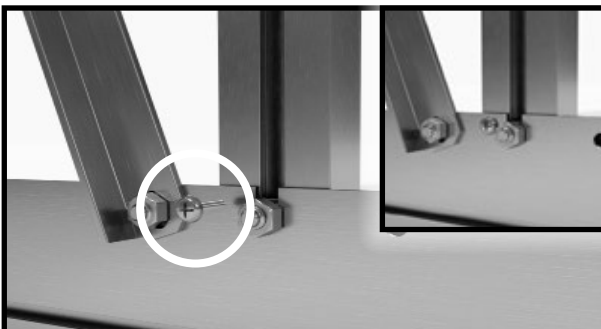

Continue with the floor profile and wall struts. Screw the base profile and the wall struts with the 4.8x13 mm drilling screw.

Repeat this step for all wall struts.

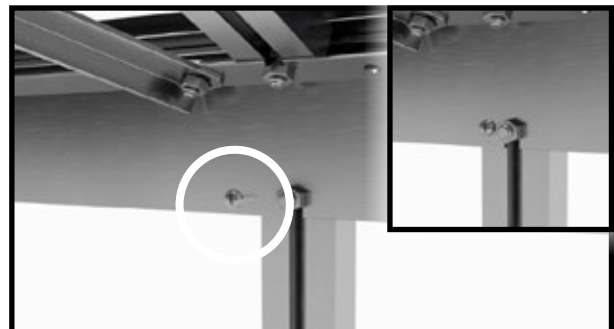

Continue with the rain gutter and wall struts. Screw the rain gutter and the wall struts with the 4.8x13 mm drilling screw.

Repeat this step for all wall struts.

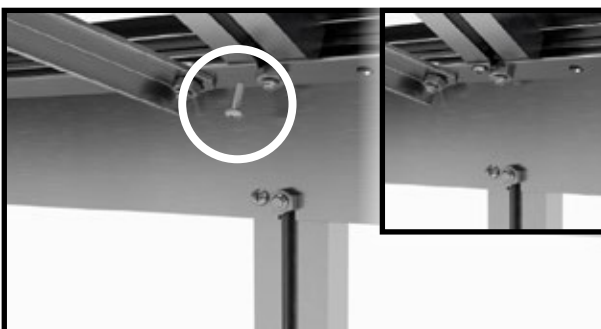

Continue with the rain gutter and roof struts. Screw the rain gutter and the roof struts with the 4.8x13 mm drilling screw.

Repeat this step for all roof struts.



Continue with the ridge and the roof struts. Screw the ridge and the roof struts with the 4.8x13 mm drilling screw.

Repeat this step for all roof struts.

Step 18 – Screwing on the struts and profiles

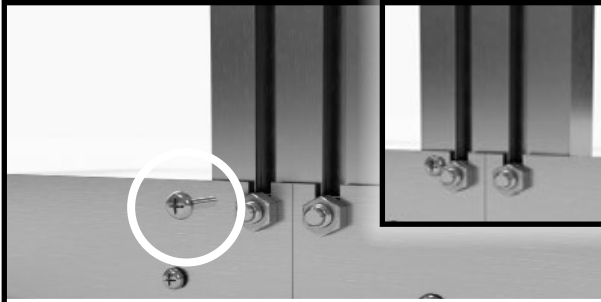

Continue with the floor profile and the coupling profiles of the side wall.

Screw the floor profile and the coupling profile of the side wall with the 4.8x13 mm drilling screw.

Repeat this step for all coupling profiles.



Continue with the rain gutter and the coupling profiles of the side wall.

Screw the rain gutter and the coupling profile of the side wall with the 4.8x13 mm drilling screw.

Repeat this step for all coupling profiles.

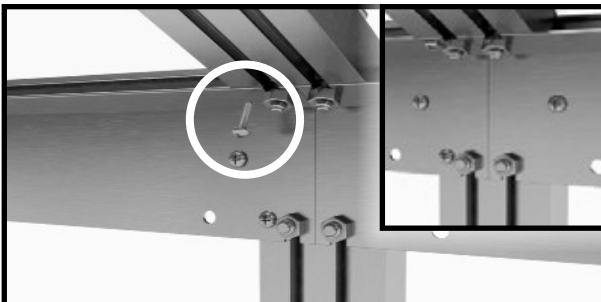

Continue with the coupling profile of the roof and the rain gutter.

Screw the coupling profile of the roof and the rain gutter with the 4.8x13 mm drilling screw.

Repeat this step for all coupling profiles.

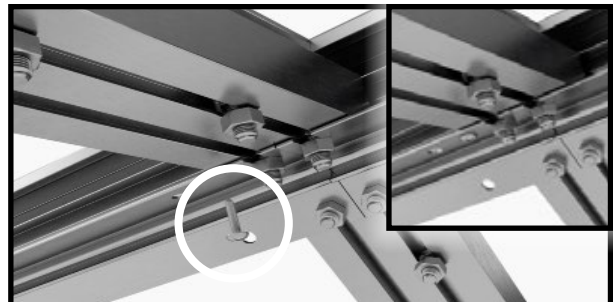

Continue with the coupling profile of the roof and the ridge.

Screw the coupling profile of the roof and the ridge with the 4.8x13 mm drilling screw.

Repeat this step for all coupling profiles.

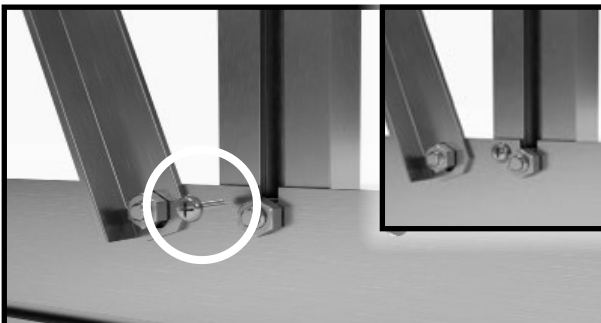

Continue with the door frame profile and the floor profile. Screw the door frame profile and the floor profile with the 4.8x13 mm drilling screw.

Repeat this step for the second door frame profile.

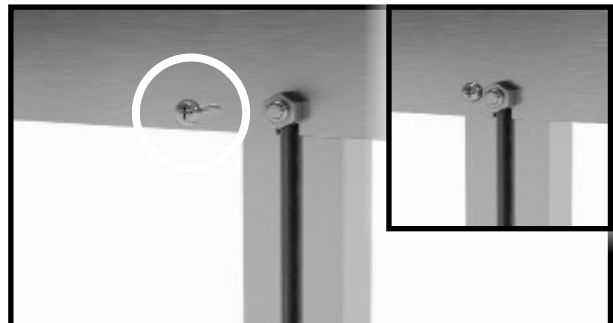

Continue with the door frame profile and cross strut.

Screw the door frame profile and the cross strut with the 4.8x13 mm drilling screw.

Repeat this step for the second door frame profiles.



Continue with the ridge and the roof corner profile. Screw the ridge and the roof corner profile with the 4.8x13 mm drilling screw.

Repeat this step for the other three roof corners.

You're finished!

Congratulations!