

ASSEMBLY INSTRUCTIONS



SAPHIR greenhouse series

GARDEN PRO greenhouse TAURUS series

Table of contents:

CONTENTS	PAGE
GENERAL INFORMATION	
Important information	3
General, intended use, explanation of symbols	4
Safety instructions	5
Before assembly, prepare the foundation	6
Assembly instructions	7
Assembly and safety instructions (short)	8
Warranty declaration, warranty in case of complaints	10 - 11
Foundation types	12
Instructions for use and information about the foundation	13
Assembly instructions for aluminium foundation (optional accessory)	14 - 17
Parts list	18 - 20
Twin-wall sheet plan	21
ASSEMBLING YOUR GREENHOUSE	
Step 1 - Assembling the front wall	22 - 31
Step 2 - Assembling the rear wall	32 - 42
Step 3 - Connecting the longitudinal parts (floor profile, rain gutter, ridge)	44 - 46
Step 4 - Assembling the longitudinal parts (floor profile, rain gutter, ridge)	47 - 49
Step 5 - Assembling the coupling profiles	50 - 53
Step 6 - Assembling the side wall and roof struts	54 - 56
Step 7 - Assembling the wind bracings on the side wall and roof	57 - 59
Step 8 - Glazing the greenhouse	60 - 69
Step 9 - Assembling the window	70 - 74
Step 10 - Assembling the door casements	75 - 78
Step 11 - Inserting the door casements	79 - 81
Step 12 - Final work	82 - 83

IMPORTANT INFORMATION

CHECKING PARTS LISTS

We strongly recommend checking the parts of the frame as well as the twin-wall sheets for completeness on the basis of the parts list.

With the guarantee that all parts are completely available, a continuous structure is ensured and you save time and hassle of having to stop assembly.

ATTENTION:

To rule out shortfalls as far as possible, we use **the most modern weighing techniques**, and the individual packing steps are continuously and fully monitored by **exact weight checks**.

This allows us to largely rule out any shortages or any mixing up of parts.

However, if a part is damaged during transport, or if a part is missing, we will send it to you as quickly as possible.

REQUEST:

The manufacturer / importer is GFP Handels GesmbH, Passauerstr. 24, A-4070 Eferding, Austria (hereinafter also referred to as „the manufacturer“, „we“ or „us“).

If you have any questions about the assembly or the product itself, please contact the supplier through whom you purchased your product.

RETURNS POLICY **FOR TWIN-WALL SHEETS**

Sometimes when stapling the wall sheet cartons, **sheets** can be **slightly damaged at the side ends** by the stapler.

Please note that **twin-wall sheets normally do not have closed side edges** and this is a unique feature we offer.

Therefore, **minor damage** (any damage no longer visible either after insertion into aluminium profiles or after attachment of the plastic clips – i.e., no longer visible **further than approx. 7 mm** into the sheet) **do not constitute grounds for complaint**, since neither the function nor the appearance is impaired as a result.

Exchanging sheets of this type is **only possible after returning the original sheets!**

General information

Read and store the assembly instructions

These assembly instructions are part of the greenhouse you have purchased (hereinafter referred to as the “product”).

It contains important information about assembly and handling.

Read the installation instructions carefully, in particular the safety instructions, before installing and using the product. Failure to comply with these assembly instructions may result in serious injury or damage to the product.

The assembly instructions are based on the standards and rules applicable in the European Union. In other countries, the country-specific guidelines and laws must also be observed.

Please keep the assembly instructions for further use. If you pass the product on to a third party, be sure to include these assembly instructions.

Intended use

The product is designed exclusively for growing or cultivating vegetables, flowers and other plants. It is not a recreation room for people and is not suitable for storing easily combustible or flammable substances.

If a fire breaks out in the product, call the fire brigade immediately and make sure that there are no people inside the product.

The product is intended exclusively for installation in gardens or similar green areas in the private sector and is not suitable for commercial use.

The product is not a children’s toy.

Please note that the assembly may be regulated by building regulations. Before installation, check whether and how you are allowed to install the product with your local building authority. If you violate these regulations, your permit may be withdrawn.

If you set up the product completely without permission or violate the building regulations, you may have to disassemble the product again. Only use the product as described in this manual. Any other use is considered as not intended and may result in damage to material or even in injury to persons.

Read all safety information and instructions. Failure to comply can cause serious injury.

The manufacturer or dealer accepts no liability for damage caused by improper or incorrect use.

Key

The following symbols and signal words are used in these assembly instructions, on the product or on the packaging.



This symbol gives you useful additional information for assembly or handling



This symbol/word indicates a hazard with a medium level of risk, which, if not avoided, could result in death or serious injury.



This symbol/word indicates a hazard with a low risk level which, if not avoided, can result in minor or moderate injury.



This signal word gives useful tips or warns of possible damage to property.

Safety instructions



Danger of explosion!

The product can heat up strongly due to solar radiation. Explosive substances may explode and highly flammable or combustible substances may catch fire if stored in the product.

Do not store highly flammable, highly combustible or explosive substances in the product.



Danger of suffocation!

Small children can put individual assembly parts in their mouths and swallow them or get caught in the packaging film. In both cases, they can suffocate in the process.

- Keep small children away from all assembly parts and the assembly site.
- Make sure that small children do not put small parts in their mouths.
- Do not allow children to play with the packaging material.



Risk of injury!

During assembly, there is a particular risk of injury for children and people with reduced physical, sensory or mental abilities. They may not be able to assess the risks correctly.

- During assembly, there is a particular risk of injury for children and people with reduced physical, sensory or mental abilities.
- Do not allow children or people with reduced physical, sensory or mental capabilities to assemble, clean, maintain or repair the product.



Risk of injury!

When stepping on the roof, you can break through the roof due to your weight.

Do not walk on roof surfaces! Risk of falling!



Risk of damage!

Improper handling of the product may result in damage to the product.

- Close the door and windows in wind and storms.
 - Free the product from snow and ice.
The roof is not designed to support a snow depth of more than 10 cm.
A depth of 36 cm for dry snow, 10 cm for wet snow and 5.5 cm for ice correspond to a weight of approx. 50 kg/m². The roof cannot support the weight of a person!
 - Do not place heavy materials on the roof or on the glazing sheets of the product.
 - Do not strike the twin-wall sheets with hard objects at low temperatures below freezing point. These may break as a result.
- Do not step on the product if the individual parts are cracked or deformed. Only replace damaged components with suitable original spare parts.
- Do not group several products together in one location.



• The manufacturer is not liable for storm, wind, water or snow load damage (we recommend that you remove snow loads from the roof during the winter months) The warranty does not cover compensation for consequential damage or financial loss.

- To prevent theft, we recommend attaching a padlock (not included in the delivery contents) to the sliding door.

Before assembly

Check product and delivery contents

NOTE!

Risk of damage!

The product can be quickly damaged if you are not careful when opening the packaging with a sharp knife or another pointed object.

- Be very careful when opening it.
1. Take the individual parts of the product out of the packaging.
 2. Use the parts lists to check whether the delivery is complete.
 3. Check whether the individual parts of the product are damaged. If this is the case, do not assemble or use the product.

Contact our service centre by email or telephone.

Determine the installation site

NOTE!

Risk of damage!

Improper handling of the product may result in damage to the product.

- Place the product in an easily accessible location that provides a minimum of protection from the wind.
- Only place the foundation and the product on sufficiently solid ground.
- If possible, do not place the product at the edge of your garden, so that it is accessible from all sides.

- Place the product on a suitable foundation and attach the product to it.
- Place the product in a suitable location only.

Preparing the foundation

NOTE!

Risk of damage!

The product is made of lightweight aluminium and hollow twin-wall sheets and is not heavy overall. Because of this, and because of its size, it offers a lot of loading surface for wind and storms, and must be secured particularly well.

- Secure the product firmly to the foundation to prevent wind and storm damage.

To install the product securely, fix it to a foundation. The foundation can be made of concrete or masonry.



The screws, brackets and dowels for securing the product to the foundation are not included in the delivery contents.

This is how you should install the foundation:

- Build the foundation at right angles in a suitable place. Foundation options are a strip foundation made of poured concrete, a strip foundation made of concrete blocks, a strip foundation made of concrete slabs or a point foundation made of concrete.
- Make sure that the foundation protrudes at least 50 mm from the ground.

Further information on the foundation and the foundation dimensions can be found on page 12.

Assembly instructions



Perform the assembly step by step and with great care. If you do not follow these assembly instructions exactly, mistakes can be made, which may be life-threatening.

- Assemble the product with great care and step by step, as specified in the assembly instructions.
- Assemble the product with at least two adults present.
- Wear protective gloves, goggles and safety shoes during assembly.
- Safeguard each other well while assembling the upper parts of the product. This is particularly important when standing on the ladder.
- Do not step on the roof of the product. There is a danger of falling off or through the roof.



Risk of injury by cutting!

There may be sharp edges on the aluminium profiles. If you do not blunt the edges, you can cut yourself on them.

- Blunt sharp edges on the aluminium profiles with a file so that you do not cut yourself or get caught on them.

NOTE!

Risk of damage!

Movements during the assembly operations can loosen screw connections again somewhat. The product may become unstable as a result.

- After assembly, tighten all screw connections using an open-ended or ring spanner.

Assembly instructions



With twin-wall sheets, it should be noted that there is an interior side and an exterior side. The side with film on it or the side labelled "OUTSIDE" on the edge has a UV-protective coating. To avoid confusion, always remove the foil after inserting each sheet.

Assembly and safety instructions (briefly summarised)

Dear Customer,

You have acquired a meticulously constructed greenhouse, made by people for whom precision has become a tradition. The compact design allows for quick assembly. The possible applications are very versatile.

We reserve the right to make further developments in the interest of technical progress.

We ask for your understanding that minor deviations from the illustrations and descriptions may arise. We wish you every success with your new garden jewel.

PLEASE NOTE:

Before assembly, identify the aluminium profiles and check the quantities and dimensions.

Before assembling the greenhouse, make sure that no parts are missing on the basis of the individual parts list.

We are unable to pay any additional expenses paid to installation companies as a result of customers failing to conduct a proper inspection in advance of assembly.

If spare parts are required, please contact the seller. Please let them know the item number of the part you need.

With twin-wall sheets, it should be noted that there is an interior side and an exterior side. The side with film on it or the side labelled "OUTSIDE" is covered with a UV-protective coating. To avoid confusion, always remove the foil after inserting each sheet.

The foundation can be made of concrete or masonry. Your greenhouse must have a firm footing and must be properly secured (see sketches on page 10) – we therefore strongly recommend that you place the greenhouse on a foundation.

CAUTION – Safety instructions for assembly!

Assembly should be carried out by 2 people. We recommend wearing protective gloves, safety goggles and safety shoes when assembling the frame and glazing (risk of injury and breakage!). After complete assembly, all screw connections must be tightened again using a spanner.

NOTE!

The manufacturer is not liable for storm, wind, water or snow load damage (**we recommend that you remove snow from the roof during the winter months**). The warranty does not cover compensation for consequential damage or financial loss. If there is visible damage to components, they must be replaced with original spare parts.

TOOL LIST:

The following tools are required for assembly:

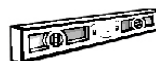

EXPLANATION OF SIGNS AND TERMS:

The following symbols are used in our assembly instructions:



Attention!
Important!



This
component



component is
moved!



Assembly
order

IT IS ESSENTIAL TO READ THE ASSEMBLY INSTRUCTIONS BEFORE STARTING THE ASSEMBLY.

THIS WILL SAVE YOU TIME, AVOID UNNECESSARY ERRORS AND YOU WILL HAVE ALREADY GAINED IMPORTANT INSIGHTS FOR THE ASSEMBLY.

BLANK PAGE

Warranty statement

In addition to the seller's statutory liability for defects in greenhouses purchased from us, we also assume a 15-year warranty on the assembly and frame and a 10-year warranty on our hollow chamber panels.

The warranty period begins with the date of taking charge of the goods. Any replacement deliveries shall not result in an extension of the warranty period.

The warranty for our greenhouses applies exclusively to the assembly and frame.

Not covered by the warranty are delivery components such as seals, plastic parts and fasteners/joining elements. Similarly, the warranty does not extend to our extra greenhouse accessories.

The warranty for our twin-wall sheets extends exclusively to their weather resistance. It only applies in connection with the purchase of one of our greenhouses.

If justified claims arise under the warranty, the following warranty plan applies to the twin-wall sheets:

Time from date of purchase of material replacement	
Up to 5 years	100%
In the 6th year	75%
In the 7th year	60%
In the 8th year	45%
In the 9th year	30%
In the 10th year	15%

The basic prerequisite for claims under the warranty is a professional installation and proper maintenance of both the frame and the hollow-chamber twin-wall sheets.

The warranty expires in the event of reassembly.

Furthermore, the warranty does not cover defects and damage directly or indirectly attributable to the following:

- Using a material in a way that does not comply with our instructions
- Damage caused by improper handling before, during or after the assembly work
- Damage caused by force majeure
- Inappropriate foundations and fastenings
- An unsuitable location (e.g., with a particular wind or heat load)
- Insufficiently secured greenhouse anchoring
- On-site modifications made to the delivered item
- Improper cleaning with unsuitable cleaning agents (including aggressive cleaning agents, salt water, etc.)
- Lack of product care (cleaning)
- Contact of the material with incompatible chemicals
- Incorrect installation of the double or triple-wall sheets and causing scratches and stresses, or the use of incompatible adhesives or sealants or other incompatible materials

Materials

- Colour changes to the powder-coated surface caused by solar radiation
- A surface change of the press-finished parts caused by the formation of a natural oxide layer
- Maintenance joints (silicone joints)
- Commercial use

Warranty claims can only be made with the original purchase receipt, provided that the customer has fulfilled all payment obligations under the purchase contract.

If a warranty claim is made within the granted warranty period and is considered to be justified, we will supply material replacement free of charge. This warranty does not cover any other warranty claims, such as compensation for direct or indirect damage or other consequential damage.

Any further liability, e.g., for the removal or installation of claimed or subsequently delivered parts, as well as for other ancillary costs or consequential damages, is not covered under this warranty.

Such liability exists only within the framework of the legal requirements.

The roof of your greenhouse must be cleared of snow and ice during the winter months!

Warranty in case of complaints/claims:

Despite careful handling in production and shipping, there may be reasons for claims. In this case, we therefore ask for your support so that the missing or defective parts can be delivered and/or re-delivered as soon as possible.

Therefore, to ensure a smooth assembly, we recommend checking the delivered goods for completeness and intactness using the supplied parts list before assembly.

If you find that parts are missing or damaged, please inform us of the parts you need by email so that we can arrange for them to be delivered as soon as possible.

The scope of warranty covers only the free replacement of the defective or broken part. Consequential or additional costs, in particular, delivery and assembly or conversion costs, are not included in the scope of warranty.

For information purposes, here is the legal basis, in brief, on which both we as a supplier and our customers may rely on:

Warranty

Warranty refers to customers' and buyers' rights to receive goods which are not defective. The defects at the time of purchase can be very different in nature:

- ➊ The product does not function as promised and expected.
- ➋ The product does not correspond to the specified and purchased size.
- ➌ The external part of the product is defective.

If such a defect becomes apparent, then the warranty is valid for a period of two years. The buyer can report this defect through a complaint to the seller and demand rectification. On the other hand, a seller is not obliged to exchange the product.

What is a buyer entitled to in the event of a complaint?

The law defines exactly what rights and claims buyers have in the event of a complaint. Buyers should note that the law divides the claims into two successive stages. In plain language, this means: if a buyer submits a complaint, they cannot immediately withdraw from the purchase contract. Nor can they immediately claim compensation in monetary form, although the law lists this as an eventual possibility. In the event of a complaint, the seller must first be given the opportunity to repair the product. This is done, for example, by...

- ➍ repairing the product.
- ➎ exchanging the product.

Only if the seller lets a deadline elapse and does not comply with the claim for rectification due to the complaint, can buyers withdraw from the purchase contract or claim financial compensation in the second step.

Based on the legal basis, the following applies:

- ➏ Warranty claims are limited to the replacement of faulty or missing material.
- ➐ There will only be financial compensation, without exception, if we are unable to remedy the defect by replacing the product!
- ➑ Defective components that have already been installed or painted are excluded from replacement.
- ➒ All other claims are excluded!

Foundation types

A supporting role – the greenhouse foundation

With a solid greenhouse foundation, do-it-yourselfers have the guarantee that their building will withstand extreme weather conditions and that their valuable plants will be reliably protected against the weather.

As a load-bearing substructure, the greenhouse foundation should guarantee structural integrity under all conceivable weather conditions. The foundation must be capable of absorbing all static forces such as dead load and roof load, wind pressure and wind suction.

Furthermore, it must not sink into the ground or lift off from the ground if it is a lightweight assembly. Also, the foundation provides the added benefit of protecting against heat loss through the ground, which is particularly important for the plants in the greenhouse.

Installing a greenhouse in the garden without appropriate anchoring is not recommended.

Does every greenhouse need a foundation?

In principle, a foundation is required for almost every project in which a building is in contact with the ground.

A greenhouse should also stand on a firm foundation.

Overview of common foundation options



Explanation of other product designation

Various trade partners also sell the **SAPHIR** greenhouses under the product name **TAURUS**. Here is a brief overview of which **TAURUS** models correspond to which **SAPHIR** models. For the sake of simplicity, only the **SAPHIR** designation is used in the instructions.

If you have purchased the greenhouse as a **TAURUS** model, please clarify at the beginning which **SAPHIR** model you are dealing with – thank you!

The model	corresponds to the model
TAURUS greenhouse, 259 x 133	SAPHIR 2 greenhouse
TAURUS greenhouse, 259 x 195	SAPHIR 3 greenhouse
TAURUS greenhouse, 259 x 259	SAPHIR 4 greenhouse
TAURUS greenhouse, 259 x 322	SAPHIR 5 greenhouse
TAURUS greenhouse, 259 x 384	SAPHIR 6 greenhouse
TAURUS greenhouse, 259 x 449	SAPHIR 7 greenhouse
TAURUS greenhouse, 259 x 513	SAPHIR 8 greenhouse

Instructions for use and information about the foundation

INSTRUCTIONS FOR MAINTENANCE AND USE:

- Every 3 to 4 months, check the screw connections of your greenhouse and tighten them if necessary.
- After strong winds or storms, check that the twin-wall sheets and screw connections are fitted securely.
- In windy and stormy weather, windows and doors must be closed.
- When temperatures are below freezing, do not strike the twin-wall sheets with hard objects.
- The roof of your greenhouse must be cleared of snow and ice during the winter months. (Caution! – The roof cannot support the weight of a person!)
- The national building regulations must be observed.

FOUNDATION

You can place your new greenhouse on a previously constructed concrete or masonry foundation (see Figure 1).

The foundation must be right-angled and level. Place your finished greenhouse on the foundation. You have two options for securing the greenhouse:

OPTION A:

Drill a hole through the floor profile. (See detail A). Secure the greenhouse to the foundation using suitable screws and dowels. (not included in the delivery contents)

VARIANT B:

Securing the greenhouse using brackets. These brackets can be fixed to the floor profile using screws (see detail B). No drilling work on the greenhouse is necessary for this. The greenhouse can then be attached to the foundation with suitable dowels and screws. (The brackets are not included in the delivery.)

NOTE! Dowels, screws and ground anchors are not included in the delivery. Your greenhouse is made of lightweight aluminium and hollow twin-wall sheets. Neither has a particularly heavy weight. However, storms and wind have a particularly large loading surface. For this reason, anchor your greenhouse particularly securely to the floor. Pay particular attention to the quality of the materials used!

CONCRETE OR MASONRY FOUNDATION

Here, you will find the matching dimensions:

Model	Width [B] Inner dimensions	Length [L] Inner dimensions	Height [H]	Level [K]
SAPHIR 2 greenhouse	2450 mm	1190 mm	approx. 80 cm	min. 50 mm
SAPHIR 3 greenhouse	2450 mm	1810 mm	approx. 80 cm	min. 50 mm
SAPHIR 4 greenhouse	2450 mm	2450 mm	approx. 80 cm	min. 50 mm
SAPHIR 5 greenhouse	2450 mm	3080 mm	approx. 80 cm	min. 50 mm
SAPHIR 6 greenhouse	2450 mm	3700 mm	approx. 80 cm	min. 50 mm
SAPHIR 7 greenhouse	2450 mm	4350 mm	approx. 80 cm	min. 50 mm
SAPHIR 8 greenhouse	2450 mm	4990 mm	approx. 80 cm	min. 50 mm
SAPHIR 9 greenhouse	2450 mm	5610 mm	approx. 80 cm	min. 50 mm

Figure 1:

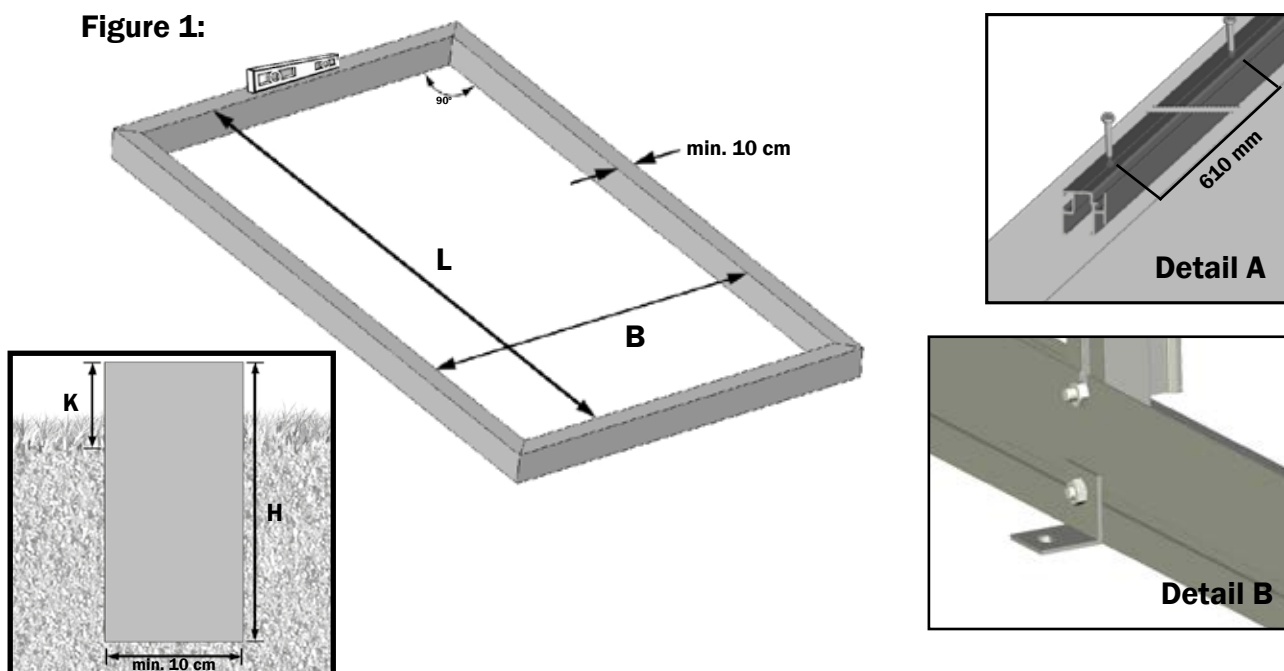

Assembly instructions for the aluminium foundation (optional accessory)

Parts list

SKETCH	PART. NO.	DESIGNATION	LENGTH	SAPHIR 2	SAPHIR 3	SAPHIR 4	SAPHIR 5	SAPHIR 6	SAPHIR 7	SAPHIR 8	SAPHIR 9
	24-1267.1 24-1892.1	Foundation profile 1267 Foundation profile 1892	1267 mm 1892 mm	6 -	4 2	8 -	6 2	10 -	8 2	12 -	10 2
	21-0050.1	Foundation longitudinal connector	50 mm	2	2	4	4	6	6	8	8
	25-0020.1	Foundation bracket	20 mm	12	12	16	16	20	20	24	24
	NG210	Foundation corner connector		4	4	4	4	4	4	4	4
	9040556	Drilling screw, 4.8x13 mm		24	24	32	32	40	40	48	48
	690509	M6x12 mm screw		24	24	32	32	40	40	48	48
	690547	M6 nut		24	24	32	32	40	40	48	48

IMPORTANT INFORMATION!

If you have decided to purchase an aluminium foundation, please note that **before the actual installation of the greenhouse, the foundation profiles must be mounted onto the floor profiles of the greenhouse!**

For this purpose, the floor profiles are each connected to the foundation profiles with two Foundation brackets.

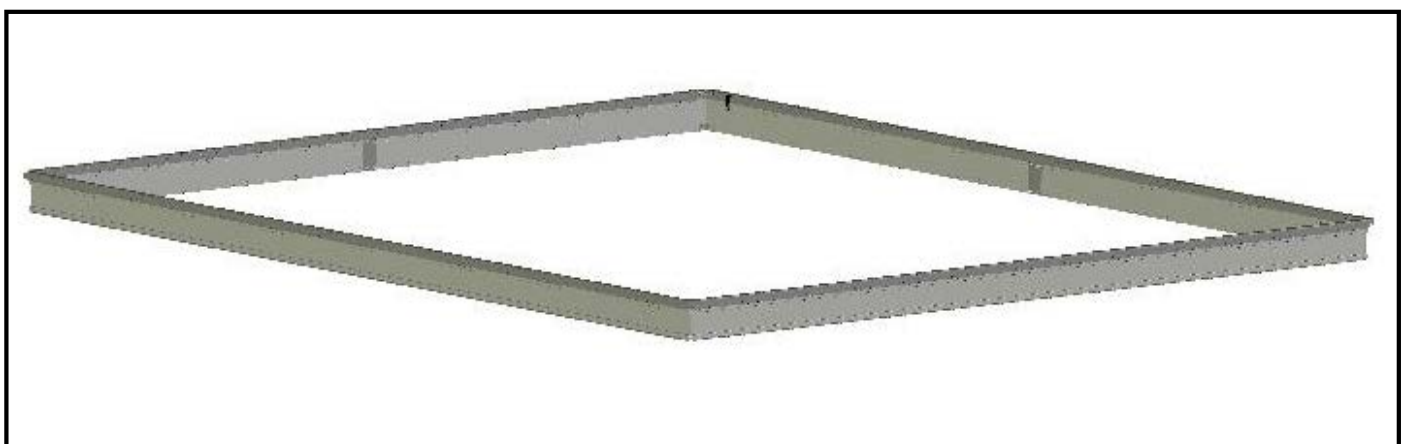

STEP 1 – Fitting the floor profiles onto the foundation profiles

In each case, make sure that the floor profile, which is placed on the foundation profile, is the same length.

Make sure that the profiles are exactly flush.

Note:

Each of the floor profiles is screwed to the foundation profile with two Foundation brackets.

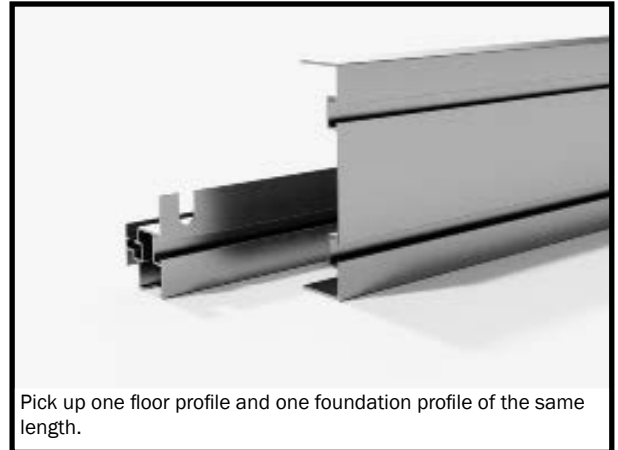

Pick up one floor profile and one foundation profile of the same length.

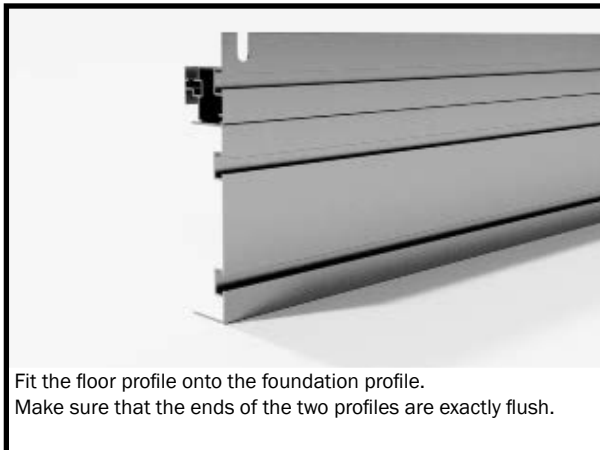

Fit the floor profile onto the foundation profile. Make sure that the ends of the two profiles are exactly flush.

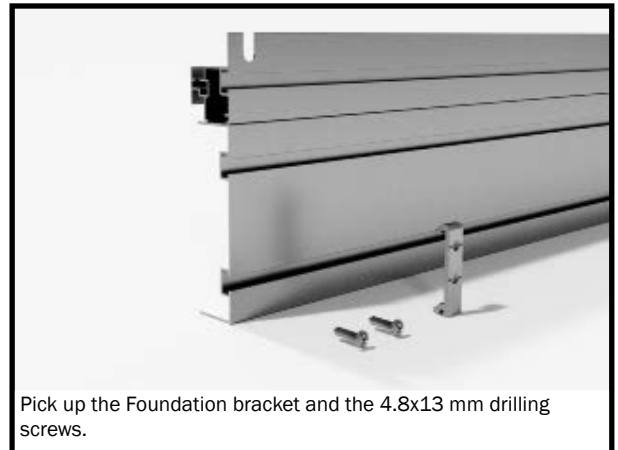

Pick up the Foundation bracket and the 4.8x13 mm drilling screws.

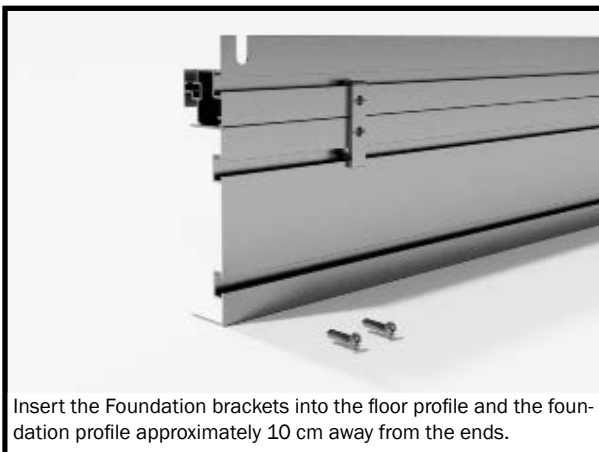

Insert the Foundation brackets into the floor profile and the foundation profile approximately 10 cm away from the ends.

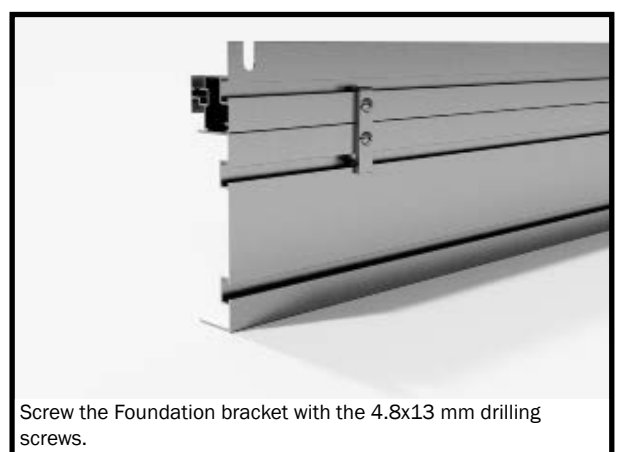

Screw the Foundation bracket with the 4.8x13 mm drilling screws.

IMPORTANT INFORMATION!

After fitting the floor profiles, please start assembling the greenhouse. To do this, go to page 22 of the Assembly Instructions.

Please note that the steps relating to the assembly of the foundation and its attachment to the floor profiles replace assembly steps that are covered later in this booklet. Where this is the case, a note in the instructions will notify you of the steps that have already been completed when assembling the foundation and attaching it to the floor profiles.

Assembling the aluminium foundation

Connecting the longitudinal parts

When connecting the floor profiles, please make sure that both the floor profiles and the foundation profiles are screwed together with the corresponding connector parts.

Before screwing them in, press the profiles firmly against each other so that there is no gap!

Note:

The following steps replace the steps shown on page 45, Figures 2a to 2d

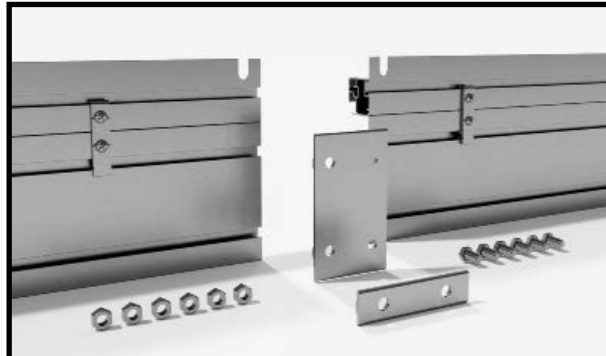

Pick up one connector part for the floor profiles, one connector part for the foundation profiles, six M6x12 mm screws and six M6 nuts.

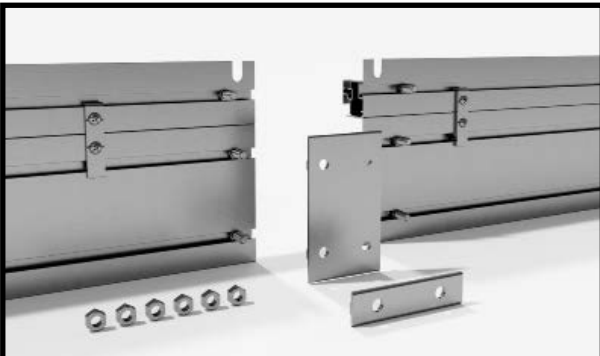

Insert one M6x12 mm screw each into the floor profile of the greenhouse on the left and right and one screw each into the screw channels of the foundation profile.

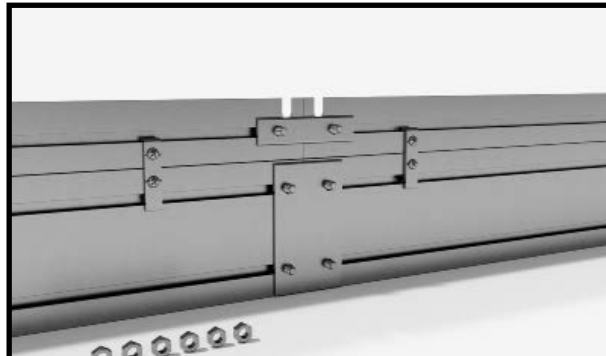

Fit the connector of the floor profiles and the connector of the foundation profile.

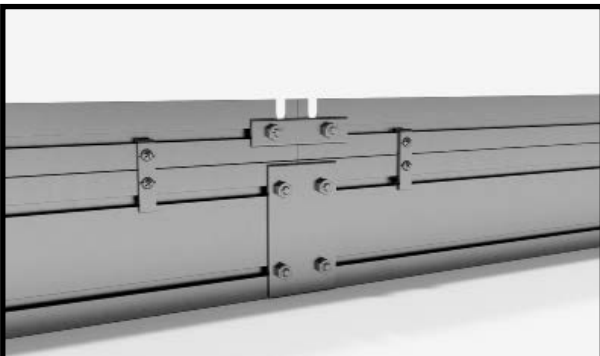

Screw the connectors tightly to the floor or foundation profiles with one M6 nut each.

Screwing the floor profiles to the front and rear wall.

Make sure that the floor profile is first screwed to the side edge profile. Then screw the greenhouse floor joint to the floor profiles of the front and side walls.

Then align the screws of the foundation profiles, put in place the foundation corner joint and screw it tightly to the foundation profiles.

Note:

The following steps replace the steps shown on page 49, Figures 3a to 3g







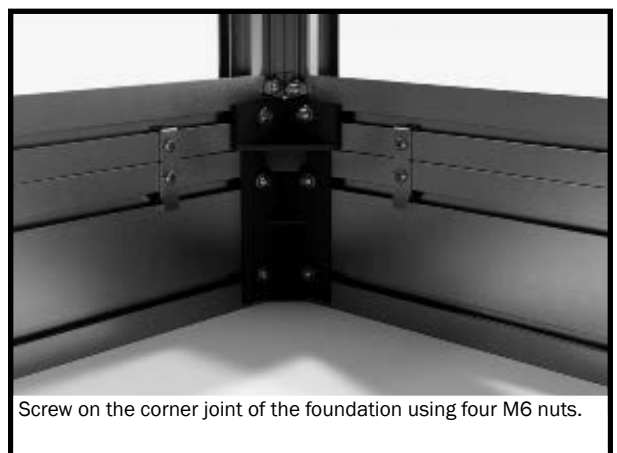
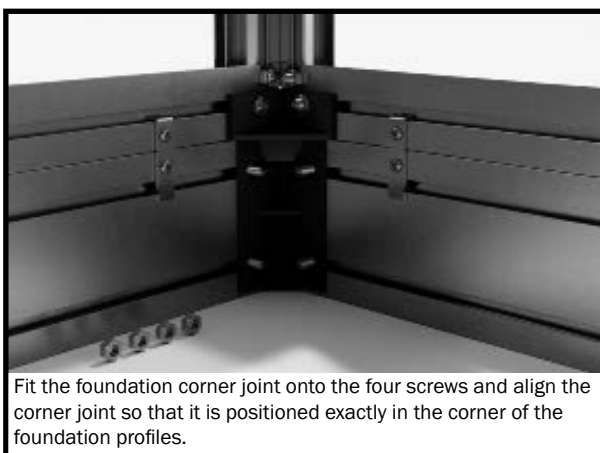
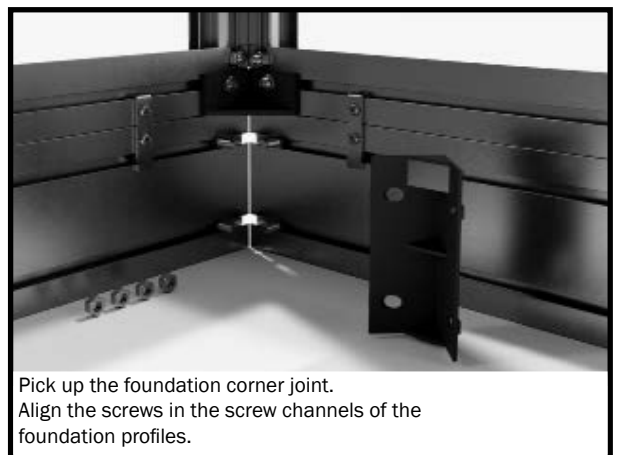
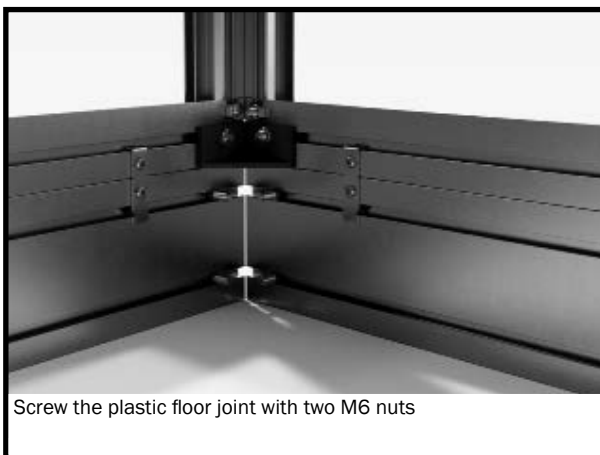
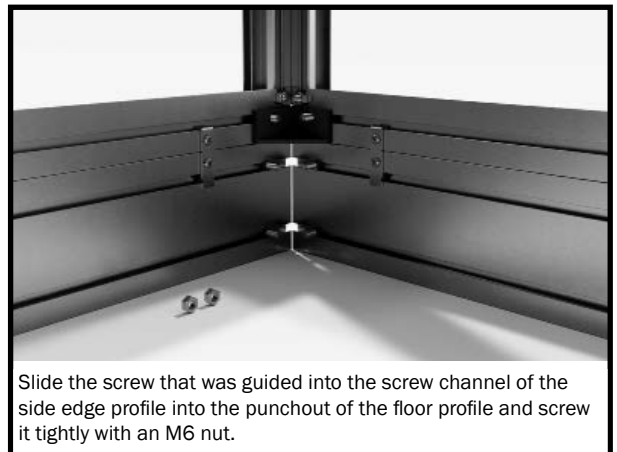
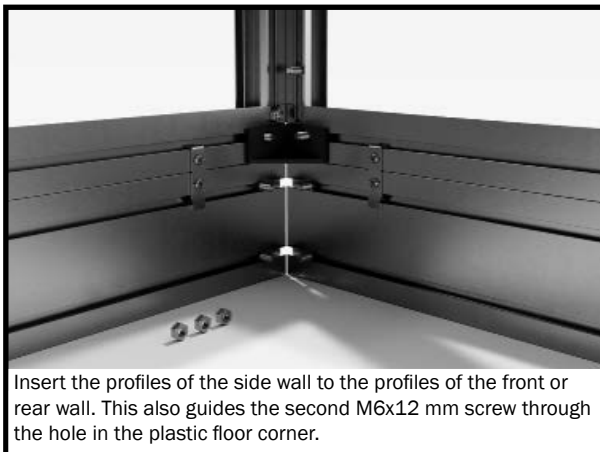
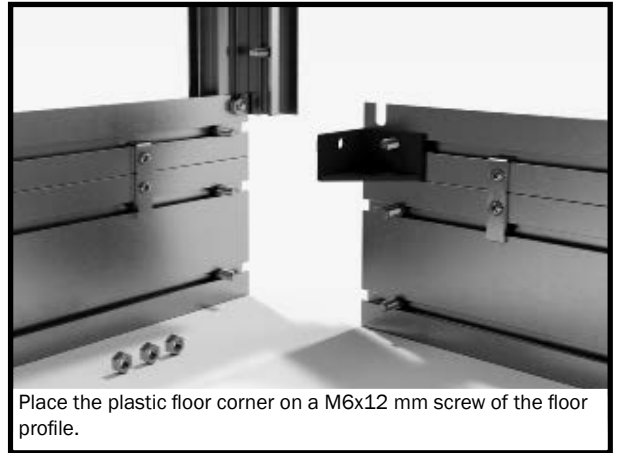

































Pick up the plastic floor joint, seven M6x12 mm screws, and M6 nuts. Insert one screw at a time into the screw channel of the floor profile.

Assembling the aluminium foundation





















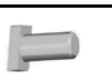

Parts list

SKETCH	PART. NO.	DESIGNATION	LENGTH	SAPHIR 2	SAPHIR 3	SAPHIR 4	SAPHIR 5	SAPHIR 6	SAPHIR 7	SAPHIR 8	SAPHIR 9
	01-1267.1	Floor profile, front/rear wall	1267 mm	4	4	4	4	4	4	4	4
	02-1368.1	Side edge profile	1368 mm	4	4	4	4	4	4	4	4
	06-1368.1	Asymmetrical terminal strip for the side edge profile	1368 mm	4	4	4	4	4	4	4	4
	08-1439.1	Roof corner profile	1439 mm	4	4	4	4	4	4	4	4
	06-1439.1	Asymmetrical terminal strip for the roof corner profile	1439 mm	4	4	4	4	4	4	4	4
	19-1297.1	Cross strut	1297 mm	2	2	2	2	2	2	2	2
	13-0337.1	Roof support	337 mm	2	2	2	2	2	2	2	2
	06-0337.1	Asymmetrical terminal strip for the roof support	337 mm	4	4	4	4	4	4	4	4
	15-1717.1	Door frame profile	1717 mm	2	2	2	2	2	2	2	2
	12-1717.1	Strut, rear wall	1717 mm	2	2	2	2	2	2	2	2
	07-1717.1	Symmetrical terminal strip for the rear wall strut	1717 mm	2	2	2	2	2	2	2	2
	13-1717.1	Coupling strut, rear wall	1717 mm	1	1	1	1	1	1	1	1
	06-1717.1	Asymmetrical terminal strip for the rear wall coupling strut	1717 mm	2	2	2	2	2	2	2	2
	15-0594.1	Window stop	594 mm	1	1	2	2	3	3	4	4
	03-0622.1	Window hinge profile	622 mm	2	2	4	4	6	6	8	8
	04-0587.1	Window profile, side	587 mm	2	2	4	4	6	6	8	8
	20-1705.1	Door frame upright	1705 mm	4	4	4	4	4	4	4	4
	11-1298.1	Door rail	1298 mm	2	2	2	2	2	2	2	2
	17-0607.1	Door profile, top	607 mm	2	2	2	2	2	2	2	2
	16-0607.1	Door profile, middle	607 mm	2	2	2	2	2	2	2	2
	18-0607.1	Door profile, bottom	607 mm	2	2	2	2	2	2	2	2
	1502-0348.1	Door rail support	348 mm	2	2	2	2	2	2	2	2

SKETCH	PART. NO.	DESIGNATION	LENGTH	SAPHIR 2	SAPHIR 3	SAPHIR 4	SAPHIR 5	SAPHIR 6	SAPHIR 7	SAPHIR 8	SAPHIR 9
	01-1267.1 01-1892.1	Floor profile, 2-section Floor profile, 3-section	1267 mm 1892 mm	2 -	- 2	4 -	2 2	6 -	4 2	8 -	6 2
	14-1267.1 14-1892.1	Rain gutter, 2-sector Rain gutter 3-sector	1267 mm 1892 mm	2 -	- 2	4 -	2 2	6 -	4 2	8 -	6 2
	05-1267.1 05-1892.1	Ridge, 2-sector Ridge 3-sector	1267 mm 1892 mm	1 -	- 1	2 -	1 1	3 -	2 1	4 -	3 1
	12-1368.1	Side wall strut	1368 mm	2	4	4	6	6	8	8	10
	07-1368.1	Symmetrical terminal strip for the side wall strut	1368 mm	2	4	4	6	6	8	8	10
	12-1439.1	Roof strut	1439 mm	2	4	4	6	6	8	8	10
	07-1439.1	Symmetrical terminal strip for the roof strut	1439 mm	2	4	4	6	6	8	8	10
	13-1368.1	Coupling strut, sidewall	1368 mm	-	-	2	2	4	4	6	6
	06-1368.1	Asymmetrical terminal strip for the side wall coupling strut	1368 mm	-	-	4	4	8	8	12	12
	13-1439.1	Coupling strut, roof	1439 mm	-	-	2	2	4	4	6	6
	06-1439.1	Asymmetrical terminal strip for the roof coupling strut	1439 mm	-	-	4	4	8	8	12	12
	1502-1481.1	Wind bracing, front/rear wall as well as side wall	1481 mm	8	8	8	8	8	8	8	8
	1502-1546.1	Wind bracing, roof	1546 mm	4	4	4	4	4	4	4	4
	1502-0639.1	Wind bracing, horizontal	639 mm	4	4	4	4	4	4	4	4
	10-0580.1	H-profile	580 mm	6	6	6	6	6	6	6	6
	23-0070.1	Longitudinal connector	70 mm	2	2	7	7	12	12	17	17
	22-0058.1	Gusset plate, gable support	58 mm	2	2	2	2	2	2	2	2
	126-0025.1	Brace for ridge and rain gutter	25 mm	-	-	3	3	6	6	9	9

Parts list

SKETCH	PART. NO.	DESIGNATION	LENGTH	SAPHIR 2	SAPHIR 3	SAPHIR 4	SAPHIR 5	SAPHIR 6	SAPHIR 7	SAPHIR 8	SAPHIR 9
	NG501	Zinc die-cast connector		6	6	6	6	6	6	6	6
	NG202L	Drain pipe, left		2	2	2	2	2	2	2	2
	NG202R	Drain pipe, right		2	2	2	2	2	2	2	2
	NG203	Floor joint		4	4	4	4	4	4	4	4
	NG204	Ridge covering		2	2	2	2	2	2	2	2
	NG205	Joint cross strut		4	4	4	4	4	4	4	4
	NG206	Connecting joint, straight		2	2	4	4	6	6	8	8
	NG209	Door roller		4	4	4	4	4	4	4	4
	NG201	Door rail protection		2	2	2	2	2	2	2	2
	NG207	Plastic connector Rain gutter		-	-	2	2	4	4	6	6
	690509	M6x12 mm screw		118	122	158	162	198	202	238	242
	690547	M6 nut		124	128	166	170	208	212	250	254
	664753	Tapping screws, 4.2x22 mm		12	12	16	16	20	20	24	24
		Drilling screw, 3.9x13		64	76	100	112	136	148	172	184
	690622	Rhombus screw, M6x12 mm		2	2	4	4	6	6	8	8
	664555	Axle pin		4	4	4	4	4	4	4	4
	7641450	Retaining clips, roof corner profile	1450 mm	4	4	4	4	4	4	4	4
	7641270	Retaining clips, rain gutter	1270 mm	2	3	4	5	6	7	8	9
	CT510 GAR3440	Hobby door seal	3440 mm	2	2	2	2	2	2	2	2
	665958	Hobby window stay		1	1	2	2	3	3	4	4

Twin-wall sheet plan:

Front wall

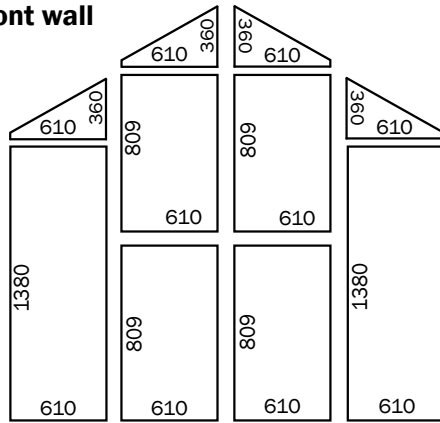

Rear wall

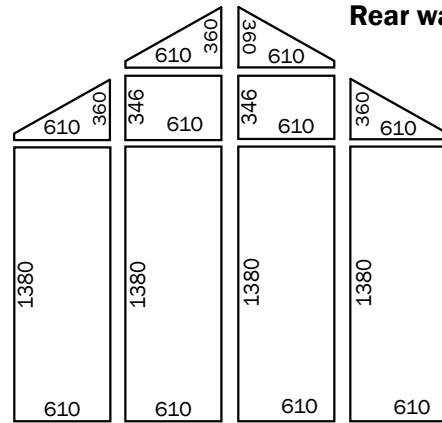

610 1380	610 827	610 603	1450 610	1380 610	
610 1380	610 1450		1450 610	1380 610	SAPHIR 2
610 1380	610 1450		1450 610	1380 610	SAPHIR 3
610 1380	610 1450	603 610	827 610	1380 610	SAPHIR 4
610 1380	610 1450		1450 610	1380 610	SAPHIR 5
610 1380	610 827	610 603	1450 610	1380 610	SAPHIR 6
610 1380	610 1450		1450 610	1380 610	SAPHIR 7
610 1380	610 1450	603 610	827 610	1380 610	SAPHIR 8
610 1380	610 1450		1450 610	1380 610	SAPHIR 9

PART. NO. 6 mm	PART. NO. 8 mm	DESIGNATION	SAPHIR 2	SAPHIR 3	SAPHIR 4	SAPHIR 5	SAPHIR 6	SAPHIR 7	SAPHIR 8	SAPHIR 9
1450/610/6	1450/610/8	Roof panel 1450x610 mm	3	5	6	8	9	11	12	14
1380/610/6	1380/610/8	Side wall as well as front and rear wall, 1380x610 mm	10	12	14	16	18	20	22	24
603/610/6	603/610/8	Window panel, 603x610 mm	1	1	2	2	3	3	4	4
827/610/6	827/610/8	Panel under the window, 827x610 mm	1	1	2	2	3	3	4	4
346/610/6	346/610/8	Small rear wall sheet 346x610 mm	2	2	2	2	2	2	2	2
809/610/6	809/610/8	Door panel, 809x610 mm	4	4	4	4	4	4	4	4
360/610/6/LI	360/610/8/LI	Left gable sheet 360x610 mm	4	4	4	4	4	4	4	4
360/610/6/RE	360/610/8/RE	Right gable sheet 360x610 mm	4	4	4	4	4	4	4	4

Step 1 – Assembling the front wall

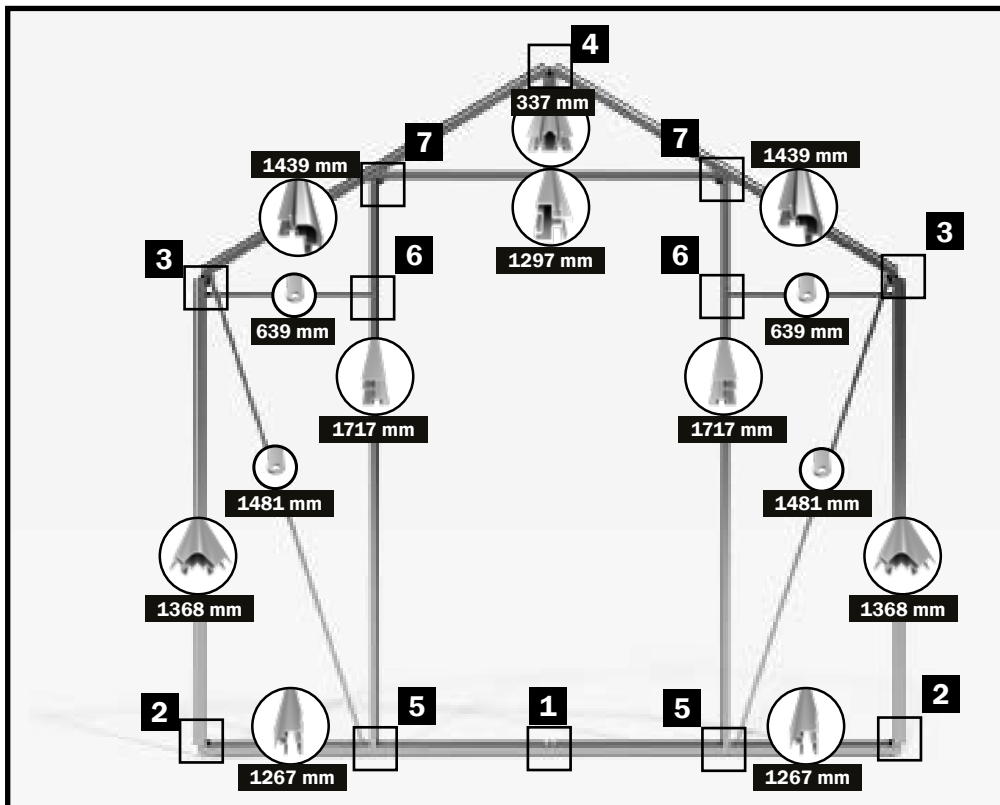

Note:

Assembling the front wall while it is lying flat on the floor is the best method.

Before you start with the assembly work, place all parts for the front wall on the floor, according to the sketch.

To simplify the assembly, you will find all the connection points presented in detail on the next page.

This overview shows you exactly how the individual connection points will look when the assembly has been completed.

For this assembly step you will need:

SKETCH	PART. NO.	DESIGNATION	LENGTH	SAPHIR 2	SAPHIR 3	SAPHIR 4	SAPHIR 5	SAPHIR 6	SAPHIR 7	SAPHIR 8	SAPHIR 9
	01-1267.1	Floor profile, front/rear wall	1267 mm	2	2	2	2	2	2	2	2
	02-1368.1	Side edge profile	1368 mm	2	2	2	2	2	2	2	2
	08-1439.1	Roof corner profile	1439 mm	2	2	2	2	2	2	2	2
	19-1297.1	Cross strut	1297 mm	1	1	1	1	1	1	1	1
	15-1717.1	Door frame profile	1717 mm	2	2	2	2	2	2	2	2
	13-0337.1	Roof support	337 mm	1	1	1	1	1	1	1	1
	1502-1481.1	Wind bracing, front/rear wall	1481 mm	2	2	2	2	2	2	2	2
	1502-0639.1	Wind bracing, horizontal	639 mm	2	2	2	2	2	2	2	2
	23-0070.1	Longitudinal connector	70 mm	1	1	1	1	1	1	1	1
	22-0058.1	Gusset plate, gable support	58 mm	1	1	1	1	1	1	1	1
	NG501	Zinc die-cast connector		3	3	3	3	3	3	3	3
	NG205	Joint cross strut		2	2	2	2	2	2	2	2
	690509	M6x12 mm screw		32	32	32	32	32	32	32	32
	690547	M6 nut		32	32	32	32	32	32	32	32

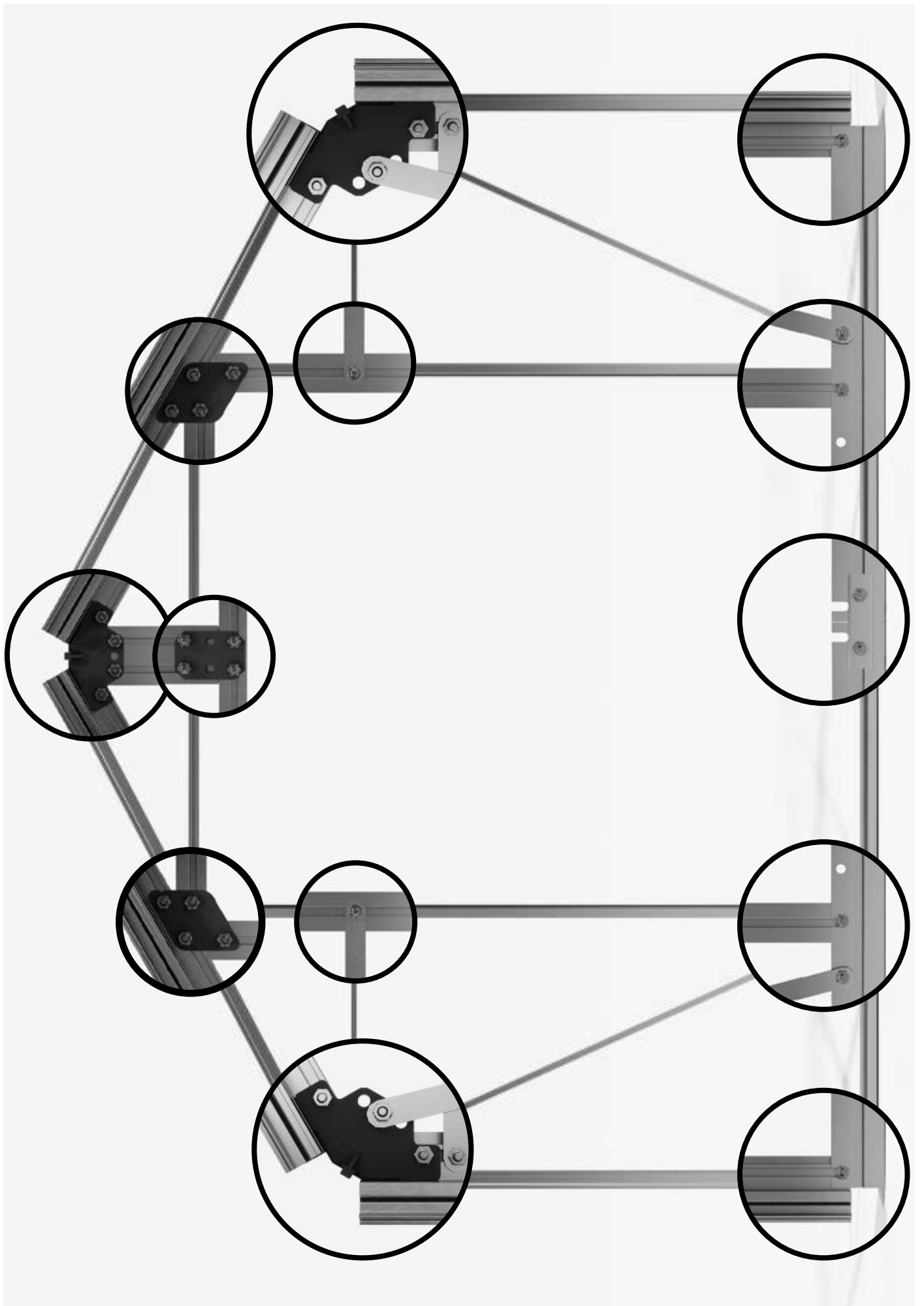

Step 1 – Assembling the front wall

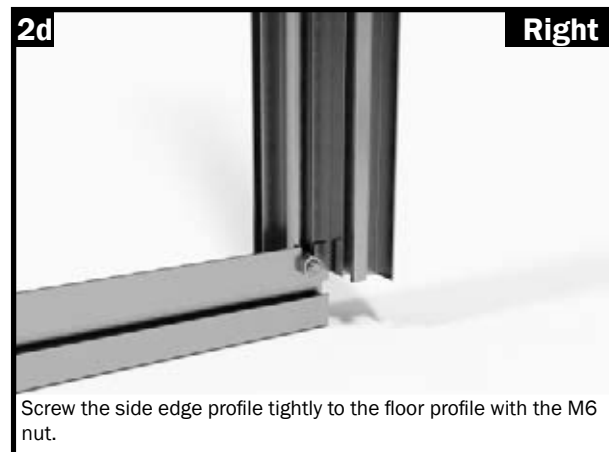
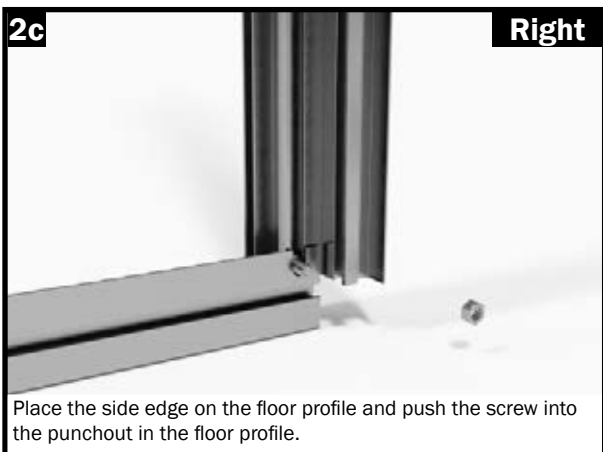
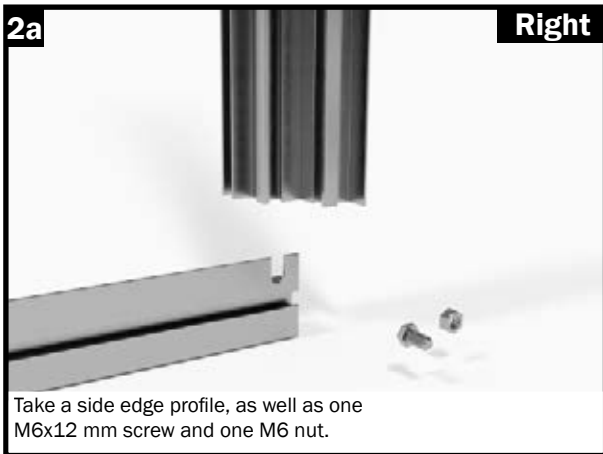
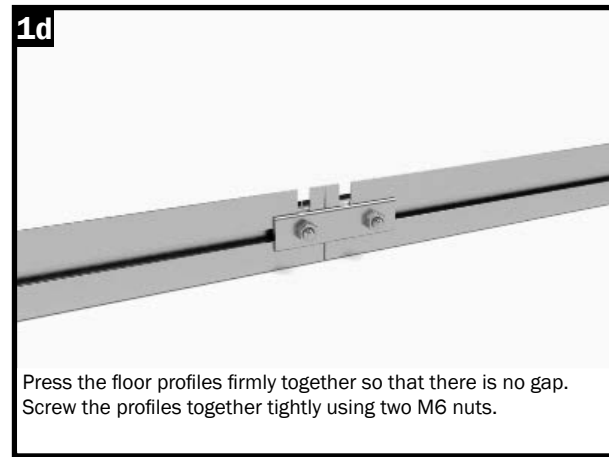
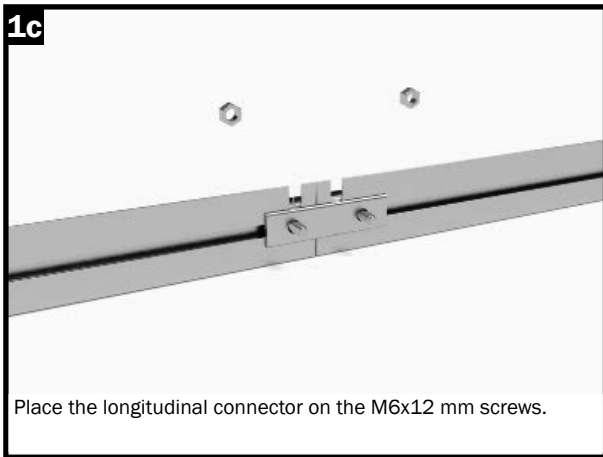
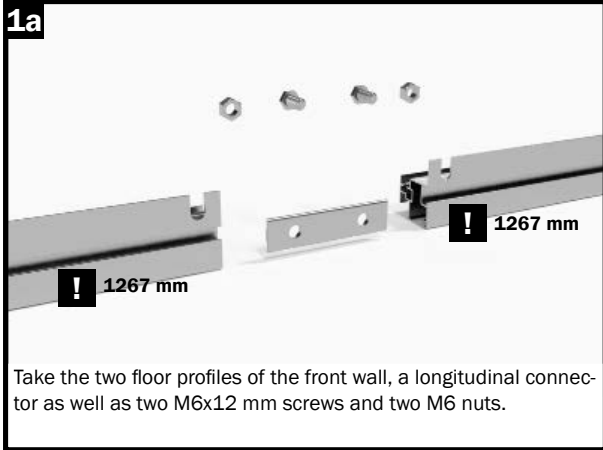

Step 1 – Assembling the front wall

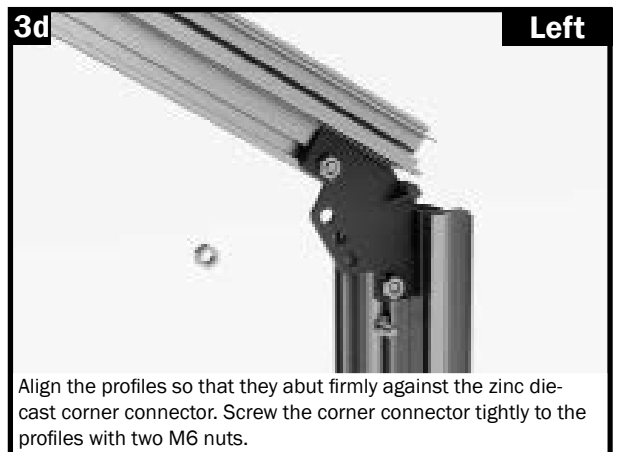
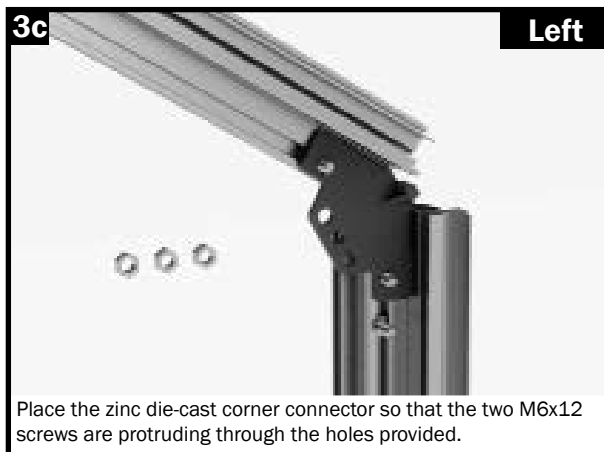
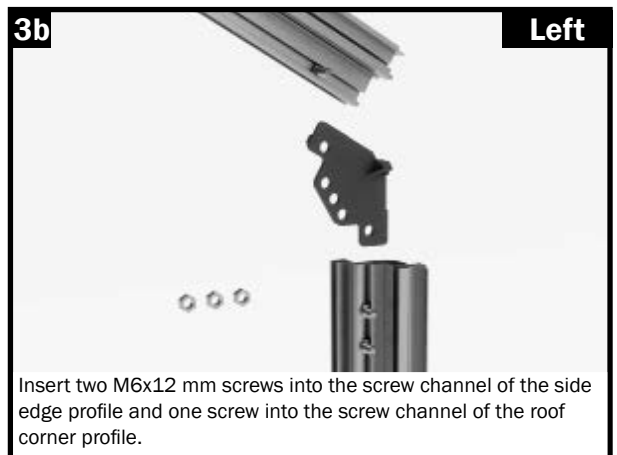
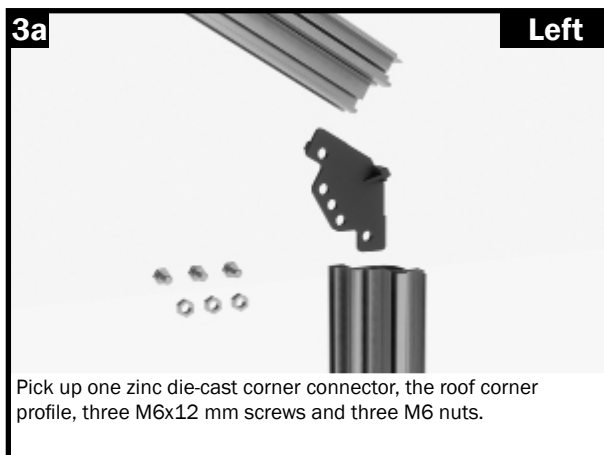
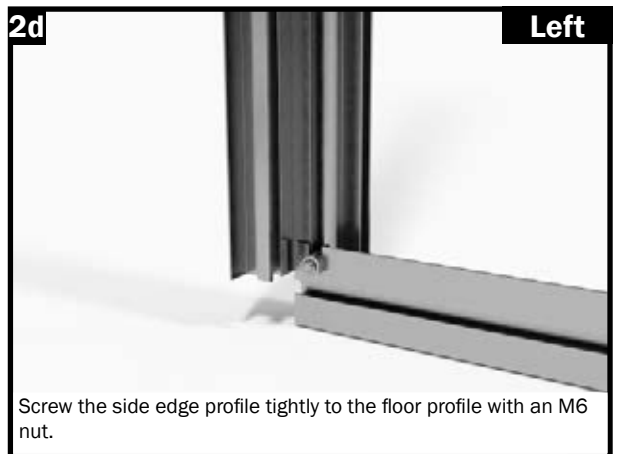
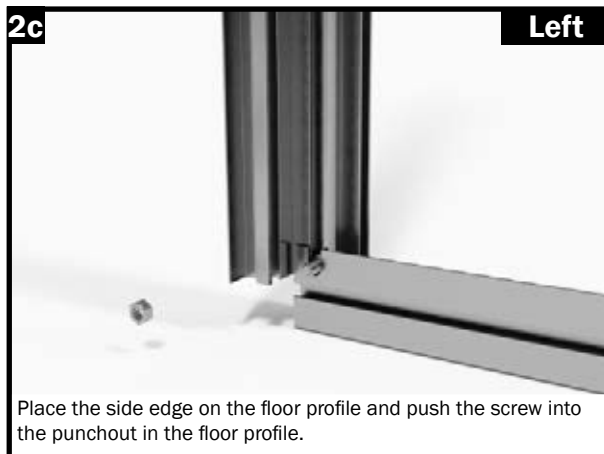
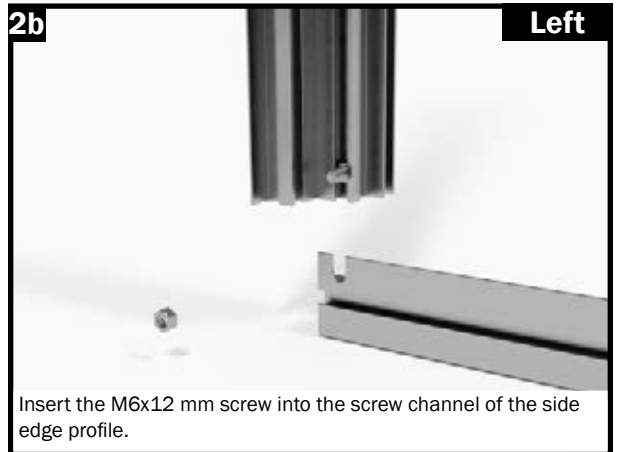
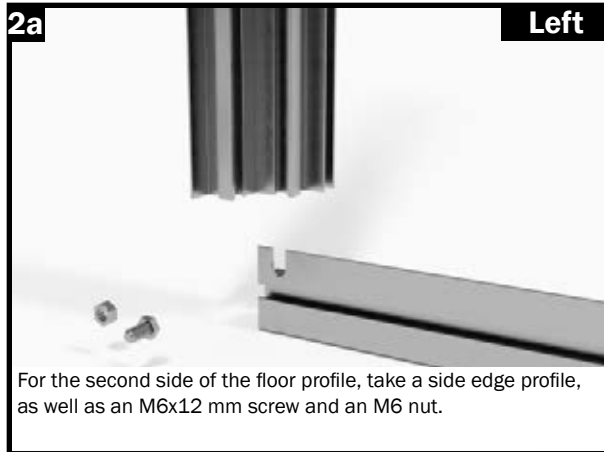

Step 1 – Assembling the front wall

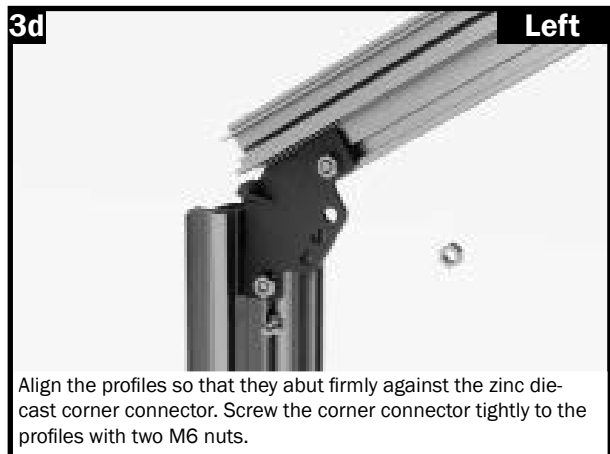
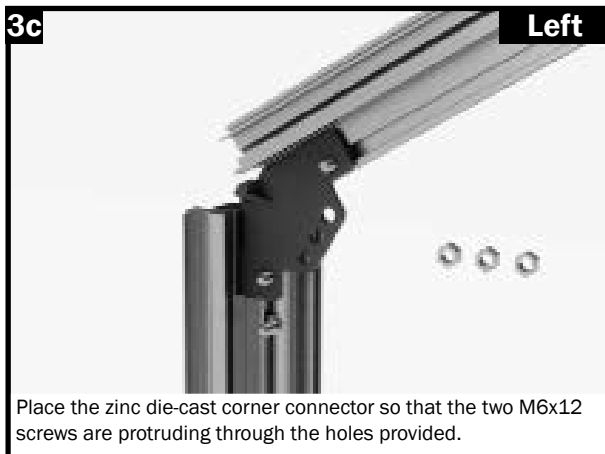
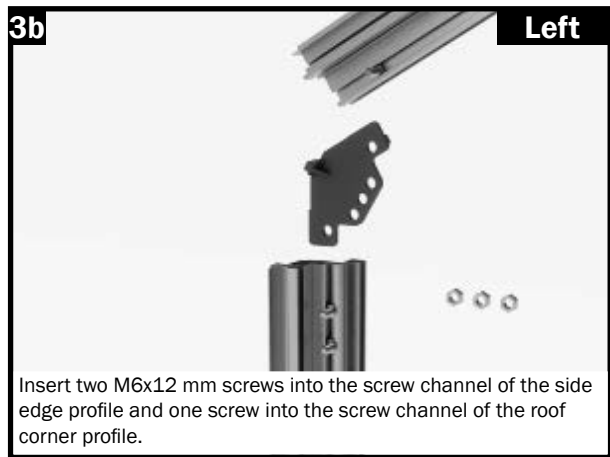
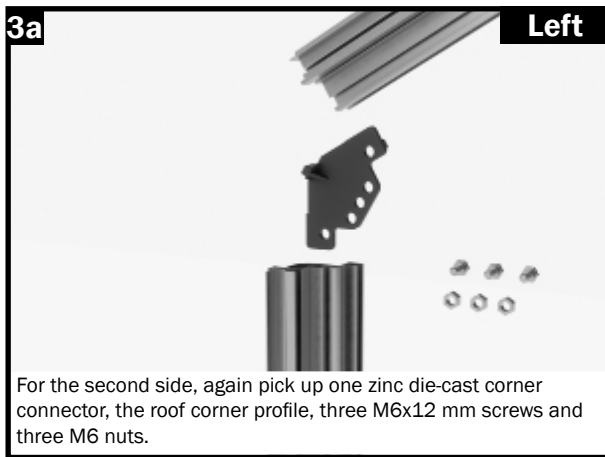

Step 1 – Assembling the front wall

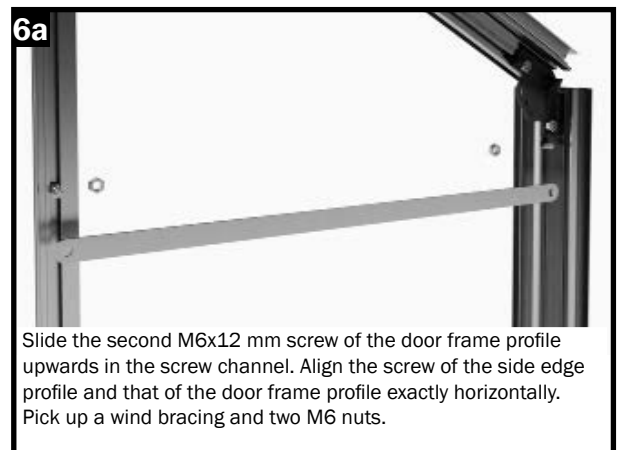
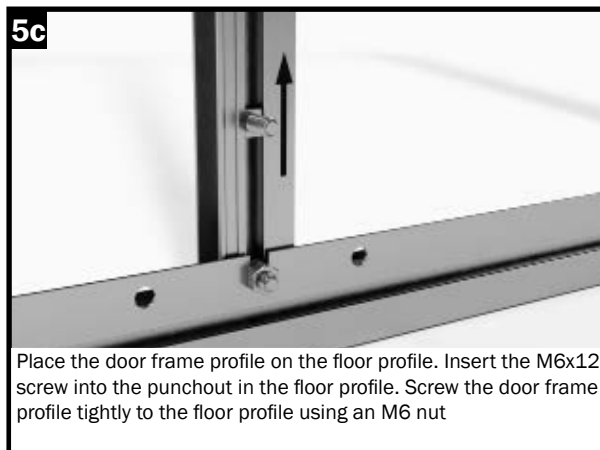
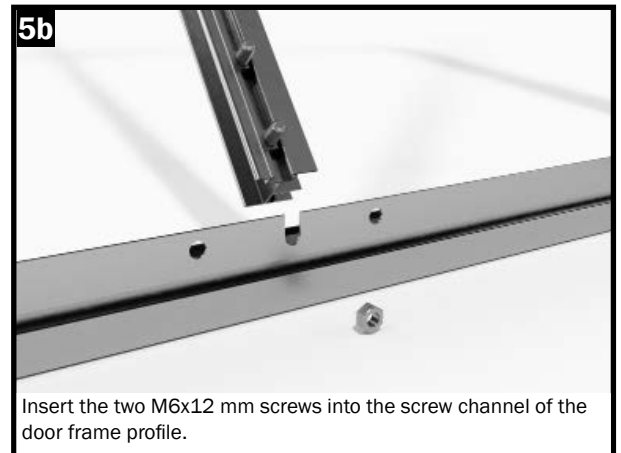
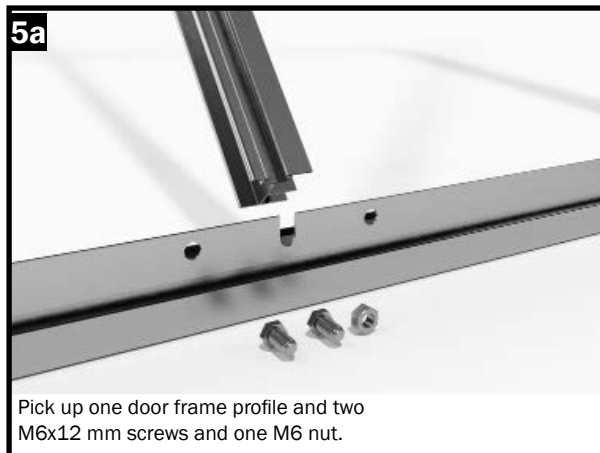
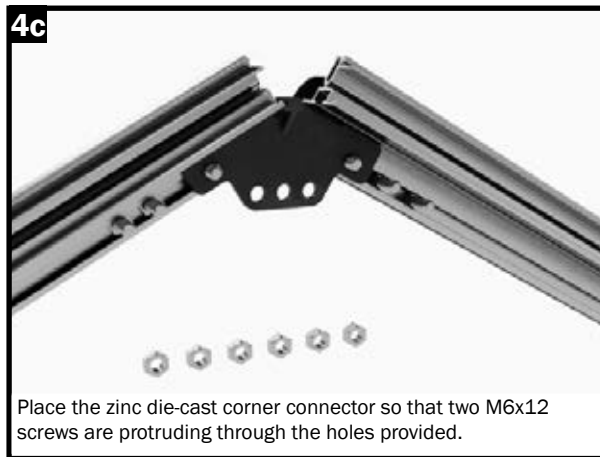
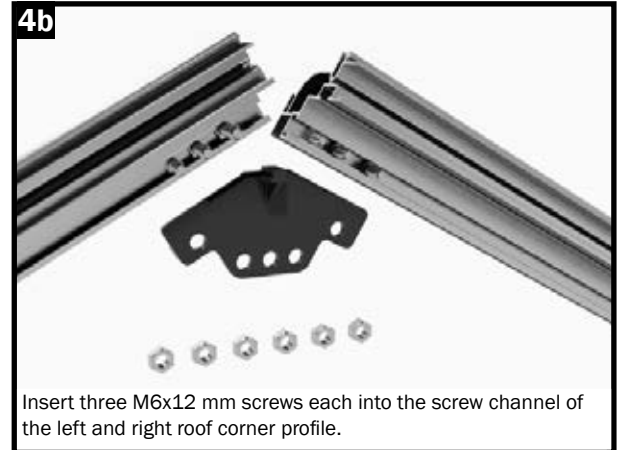
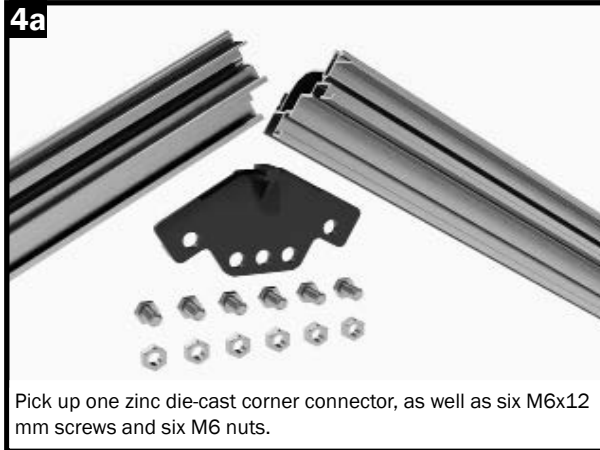

Step 1 - Assembling the front wall

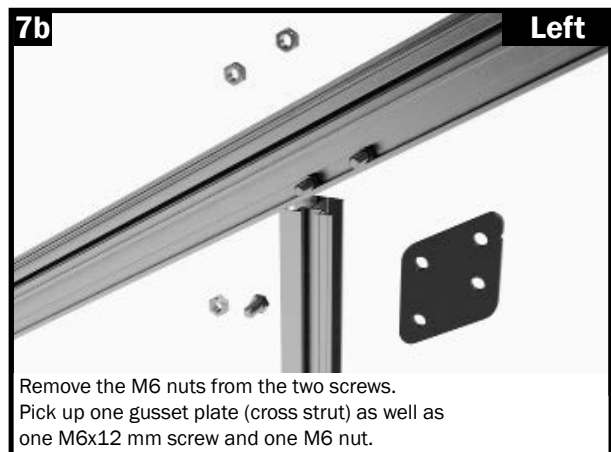
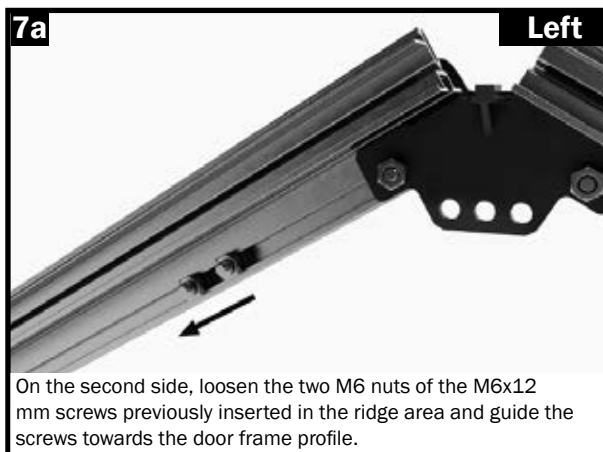
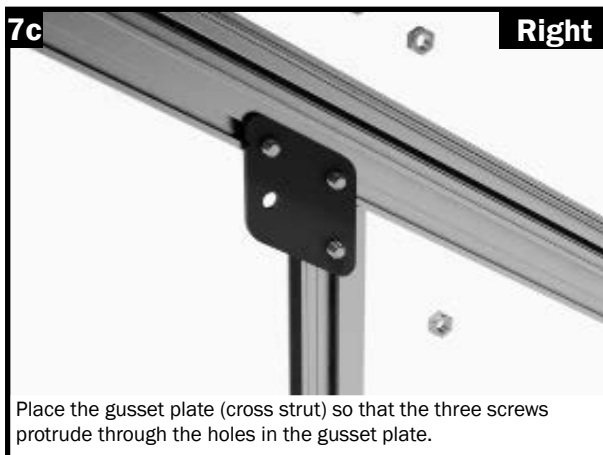
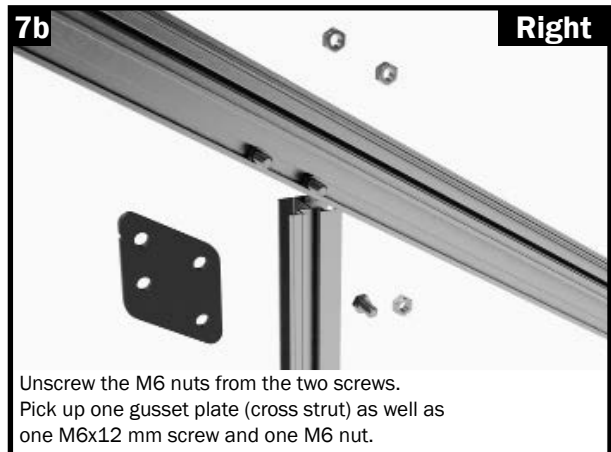
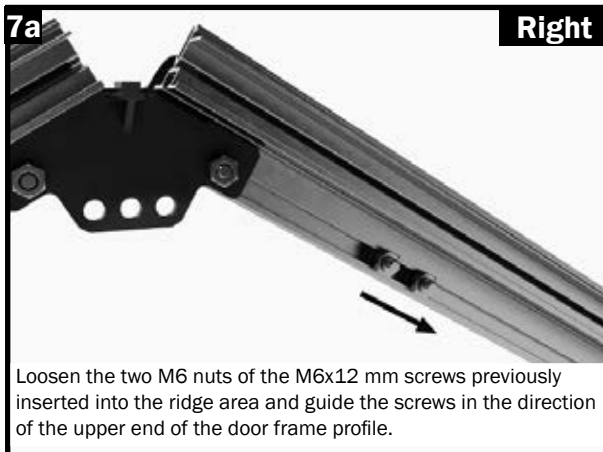
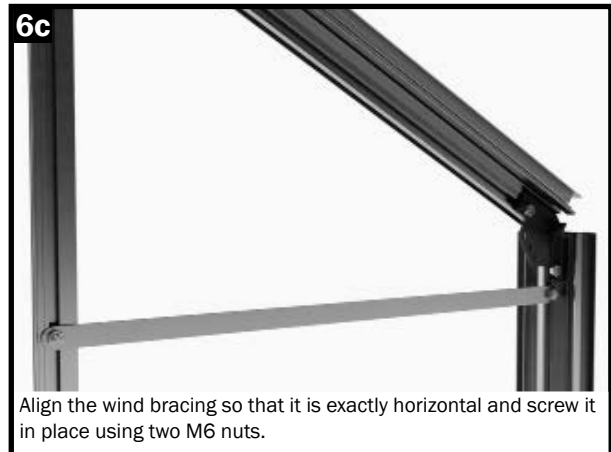
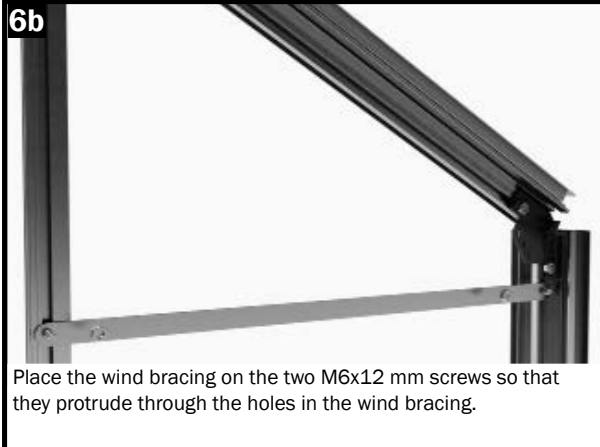

Step 1 - Assembling the front wall

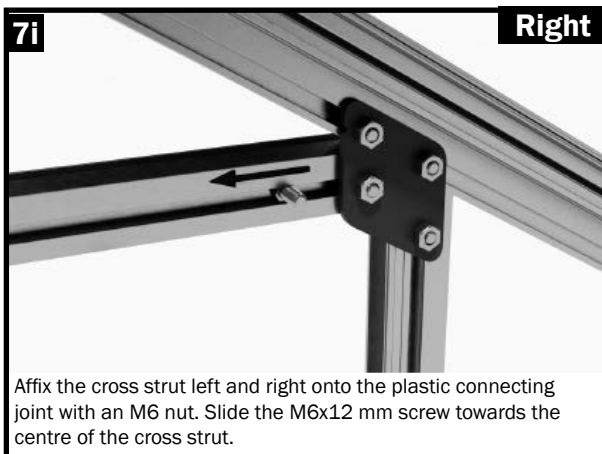
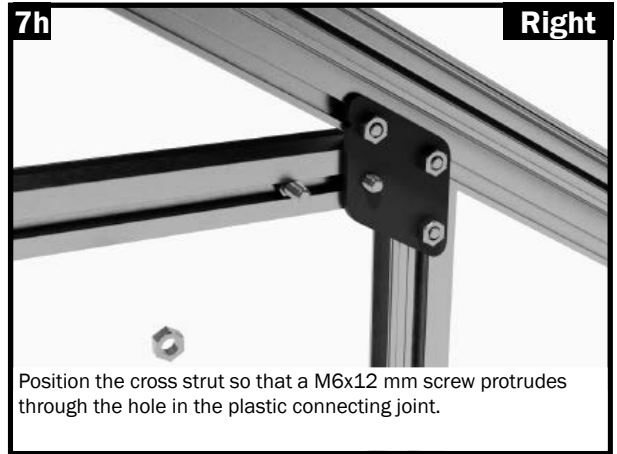
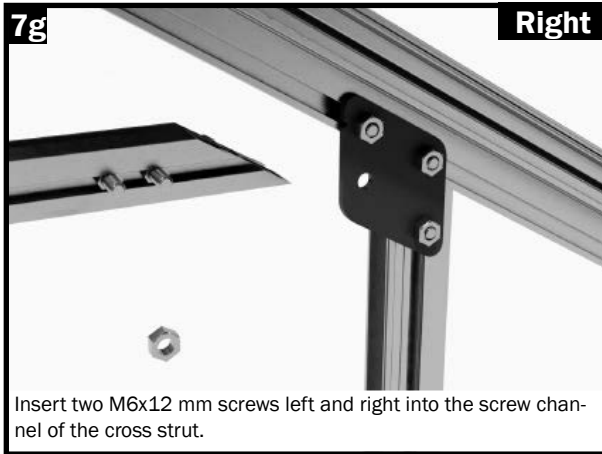
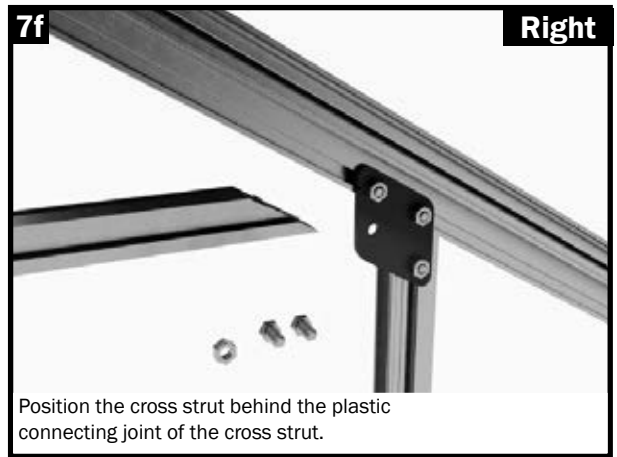
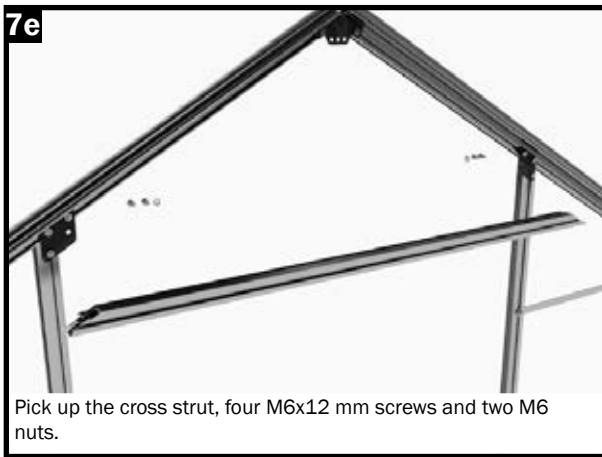
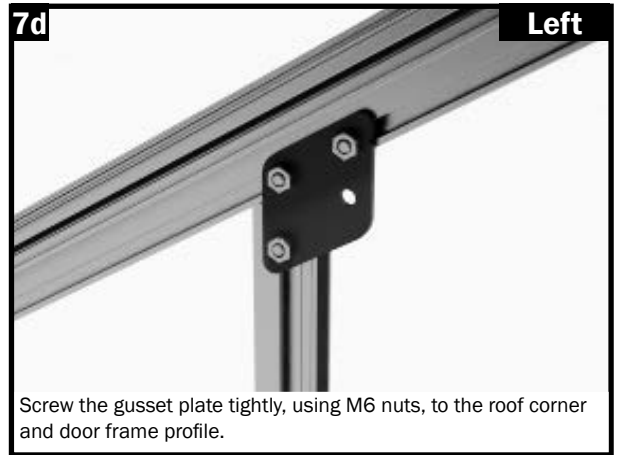
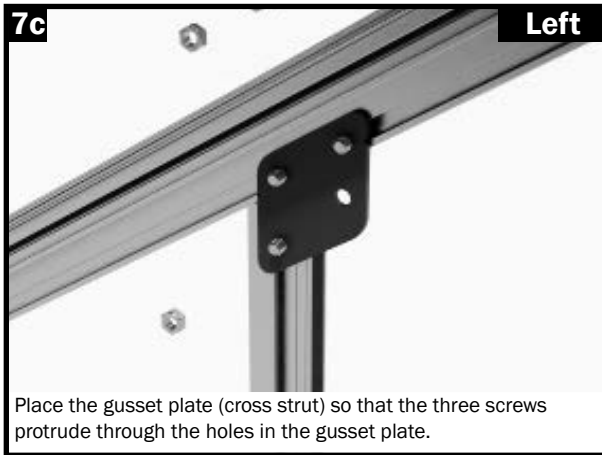

Screw the left side of the cross strut in the same way as shown in Figures 7f to 7i.

Step 1 – Assembling the front wall (attaching the two wind bracings)

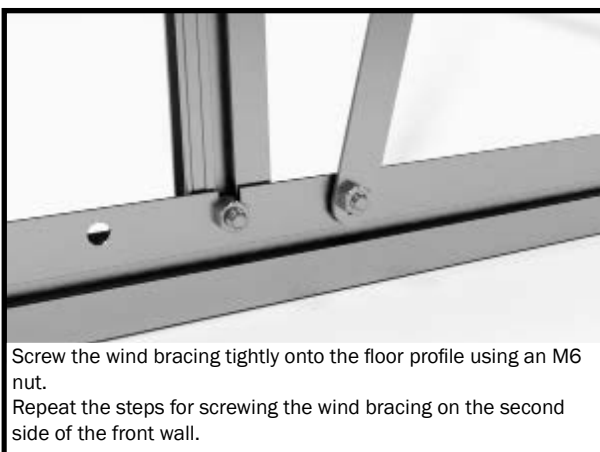
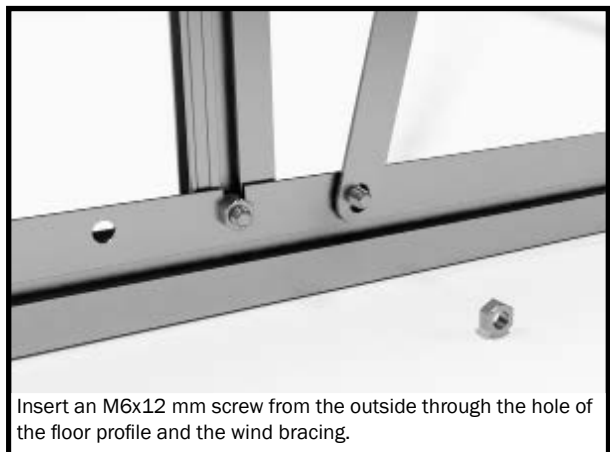
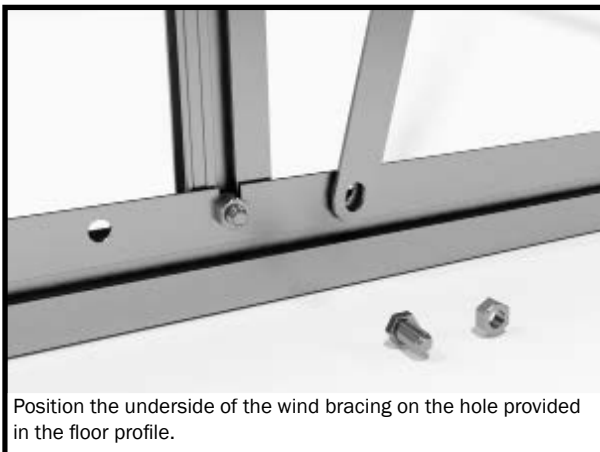
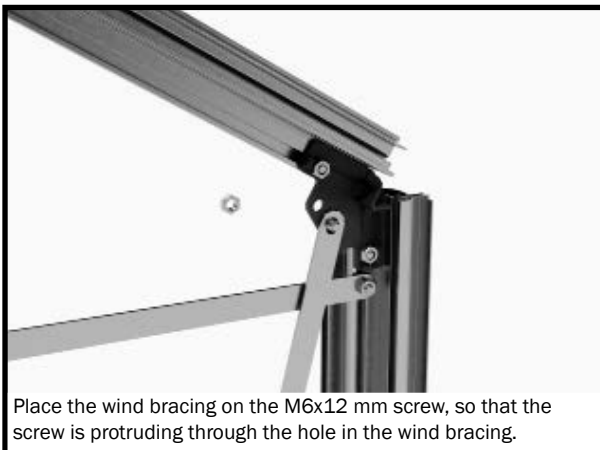

Step 1 – Mounting the front wall (attaching the roof support)

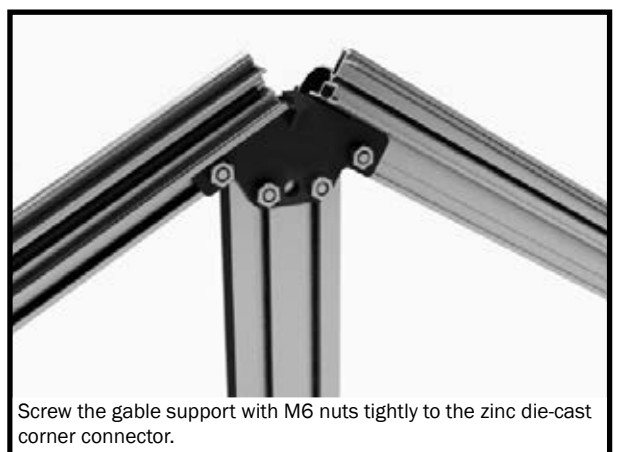
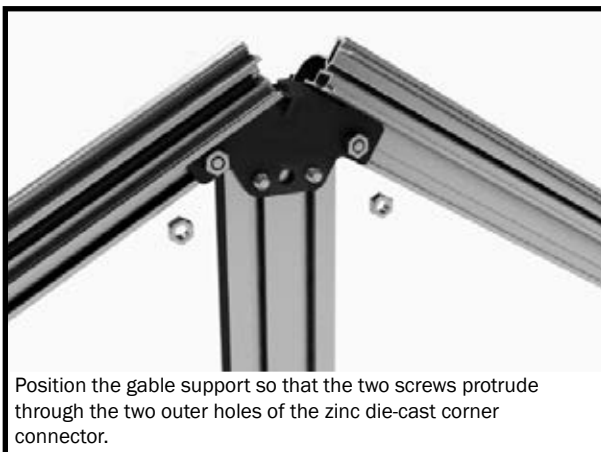
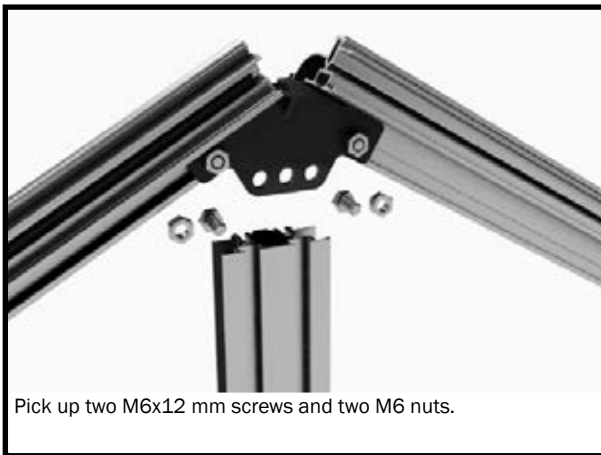
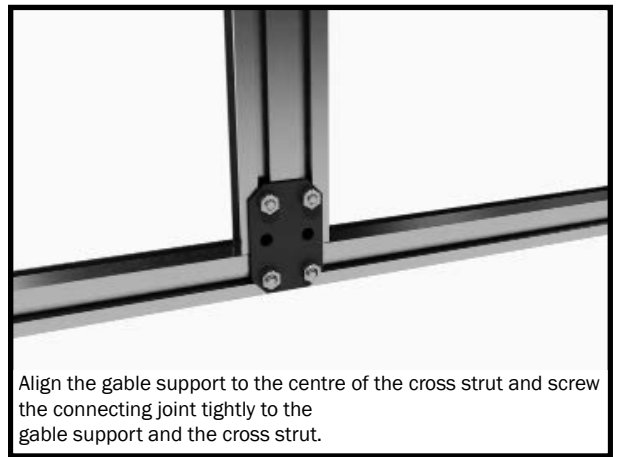
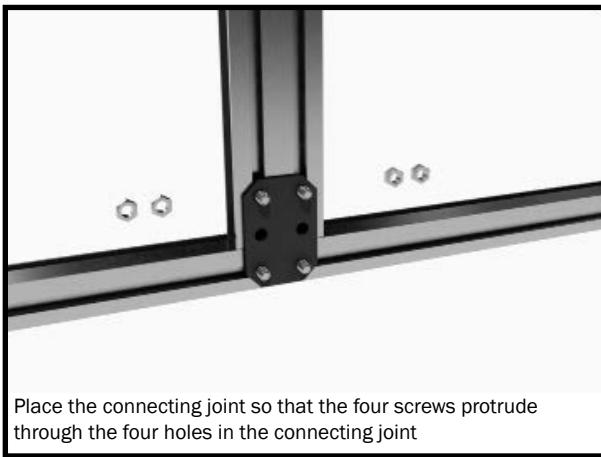
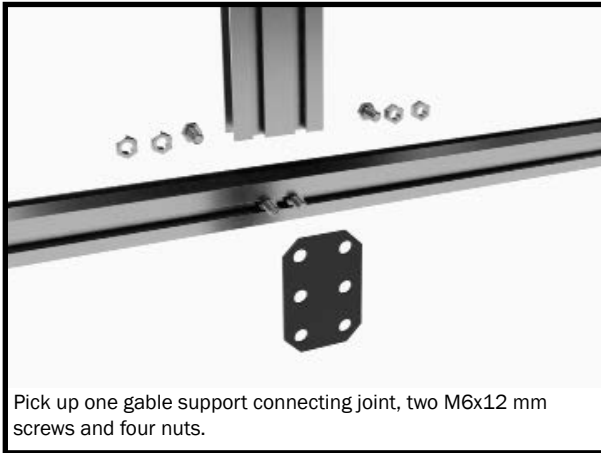

Step 2 – Assembling the rear wall

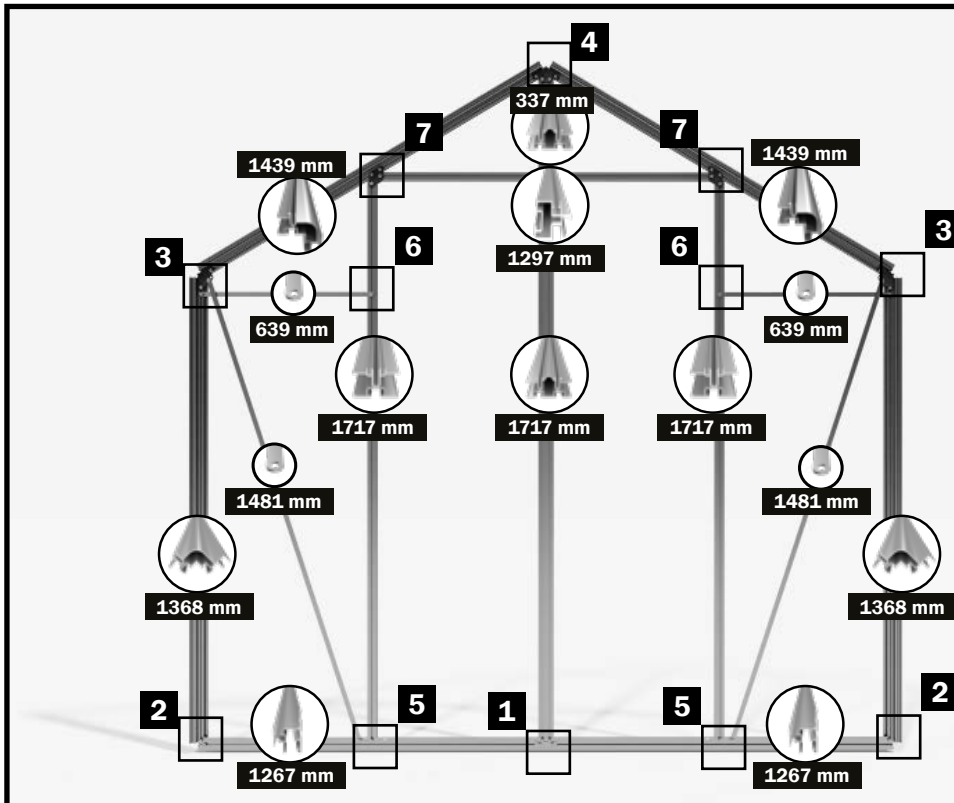

Note:

Assembling the rear wall while it is lying flat on the floor is the best method.

Before you start with the assembly work, place all parts for the rear wall on the floor, according to the sketch.

To simplify the assembly, you will find all the connection points presented in detail on the next page.

This overview shows you exactly how the individual connection points will look when the assembly has been completed.

For this assembly step you will need:

SKETCH	PART. NO.	DESIGNATION	LENGTH	SAPHIR 2	SAPHIR 3	SAPHIR 4	SAPHIR 5	SAPHIR 6	SAPHIR 7	SAPHIR 8	SAPHIR 9
	01-1267.1	Floor profile, front/rear wall	1267 mm	2	2	2	2	2	2	2	2
	02-1368.1	Side edge profile	1368 mm	2	2	2	2	2	2	2	2
	08-1439.1	Roof corner profile	1439 mm	2	2	2	2	2	2	2	2
	19-1297.1	Cross strut	1297 mm	1	1	1	1	1	1	1	1
	12-1717.1	Strut, rear wall	1717 mm	2	2	2	2	2	2	2	2
	13-1717.1	Coupling strut, rear wall	1717 mm	1	1	1	1	1	1	1	1
	13-0337.1	Roof support	337 mm	1	1	1	1	1	1	1	1
	1502-1481.1	Wind bracing, front/rear wall	1481 mm	2	2	2	2	2	2	2	2
	1502-0639.1	Wind bracing, horizontal	639 mm	2	2	2	2	2	2	2	2
	23-0070.1	Longitudinal connector	70 mm	1	1	1	1	1	1	1	1
	22-0058.1	Gusset plate, gable support	58 mm	1	1	1	1	1	1	1	1
	NG501	Zinc die-cast connector		3	3	3	3	3	3	3	3
	NG205	Joint cross strut		2	2	2	2	2	2	2	2
	690509	M6x12 mm screw		36	36	36	36	36	36	36	36
	690547	M6 nut		36	36	36	36	36	36	36	36

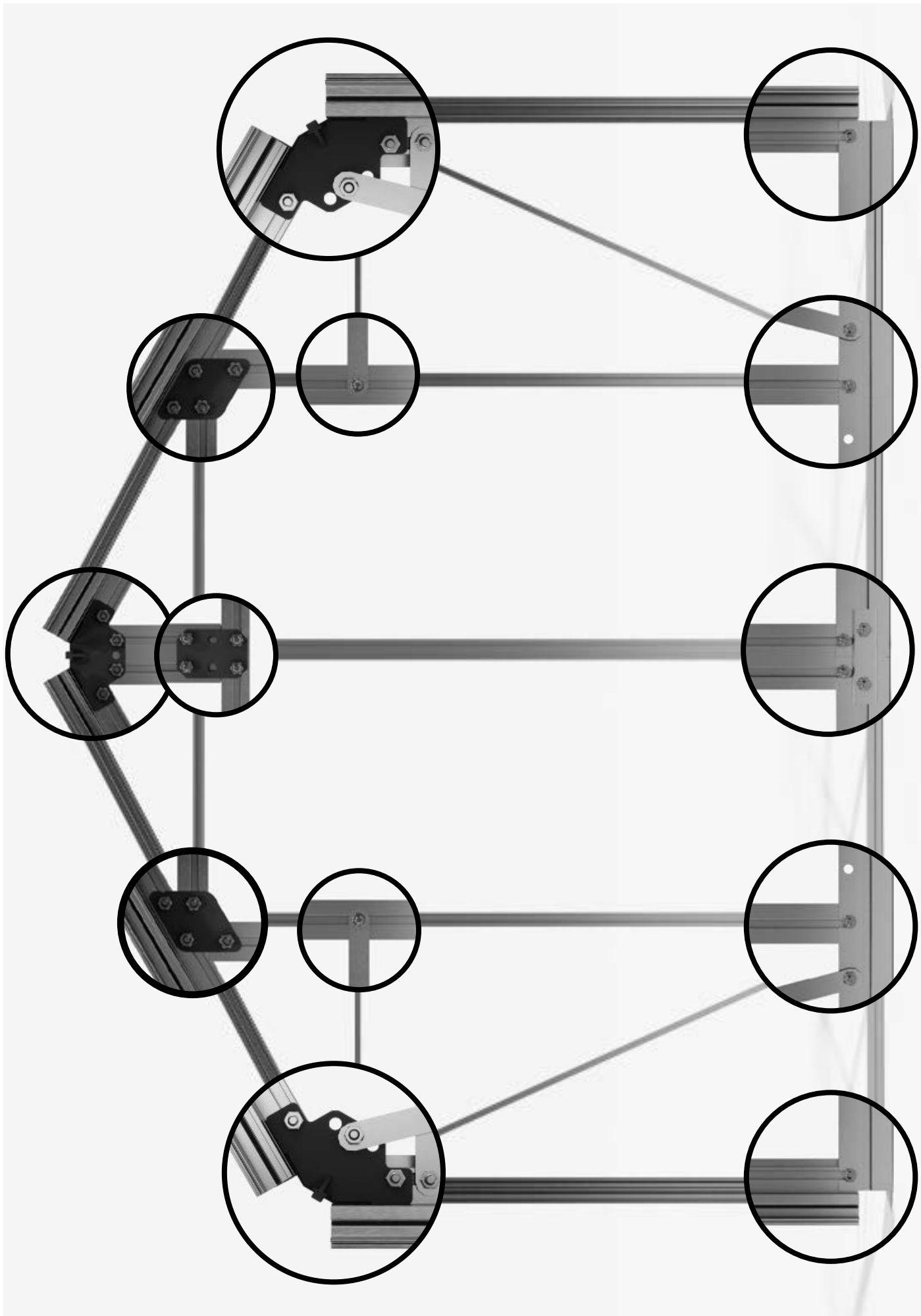

Step 2 – Assembling the rear wall

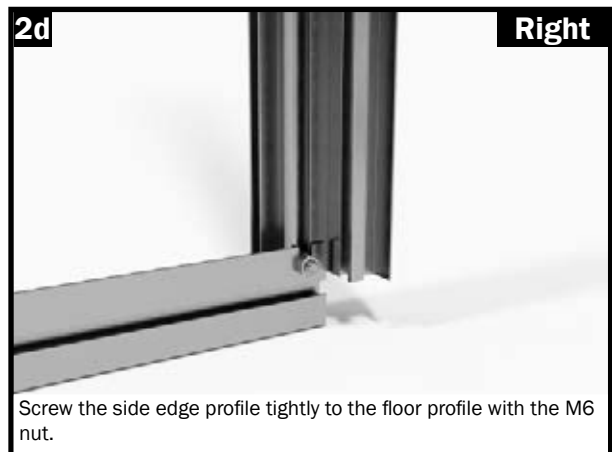
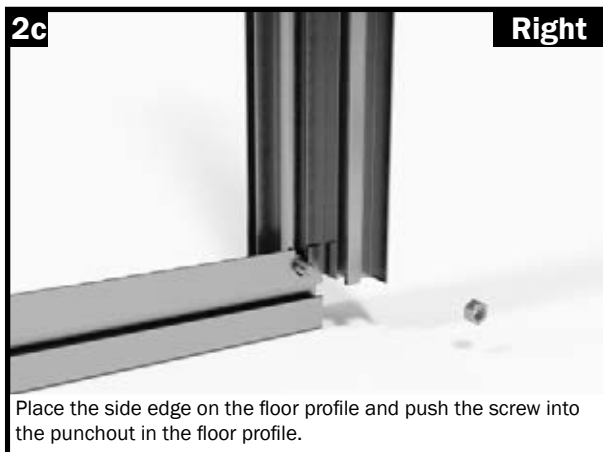
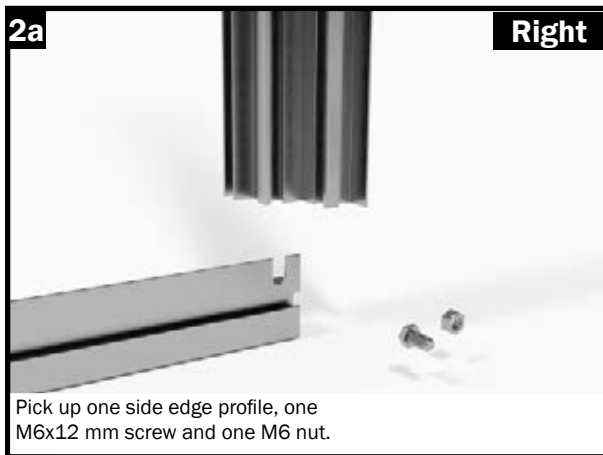
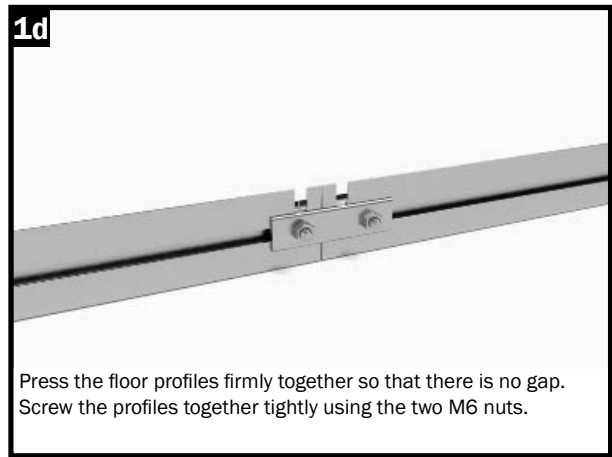
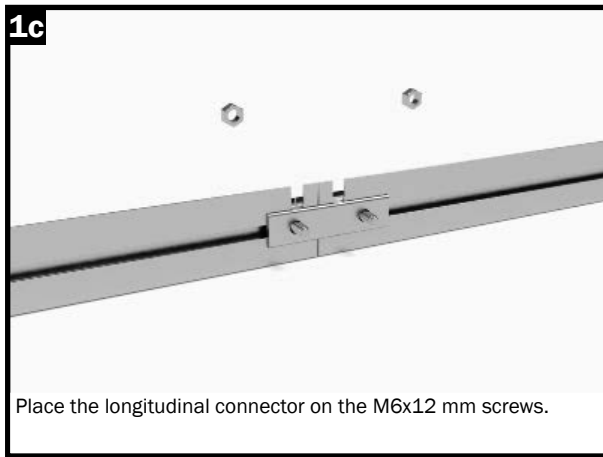
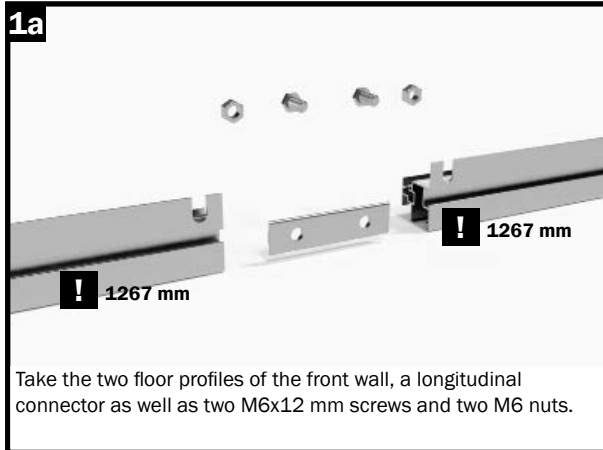

Step 2 – Assembling the rear wall

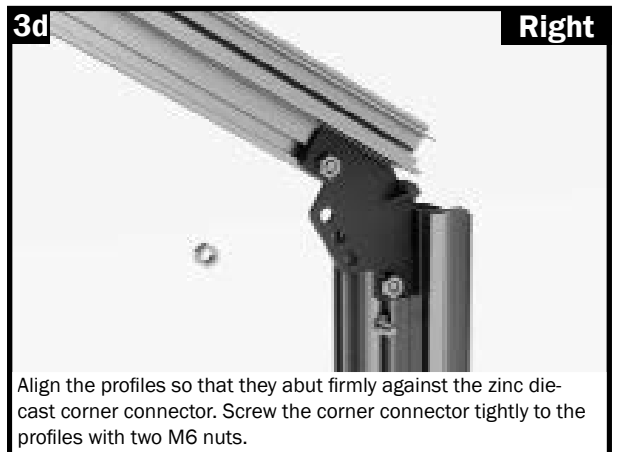
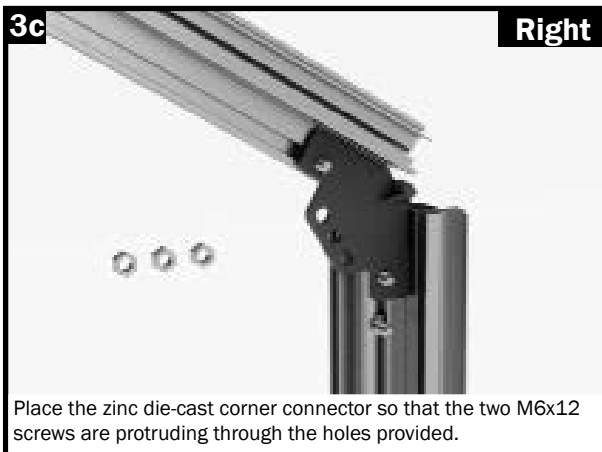
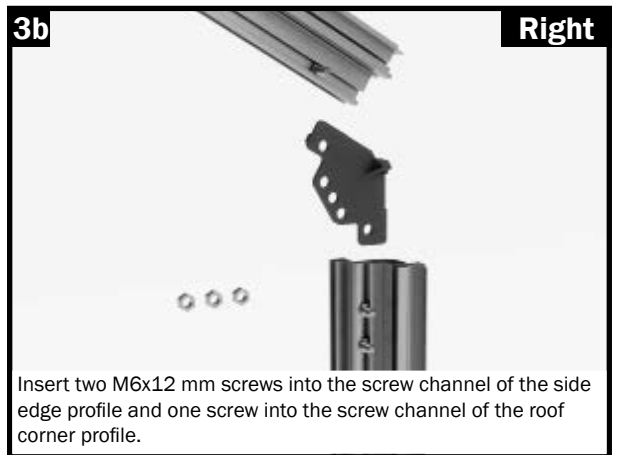
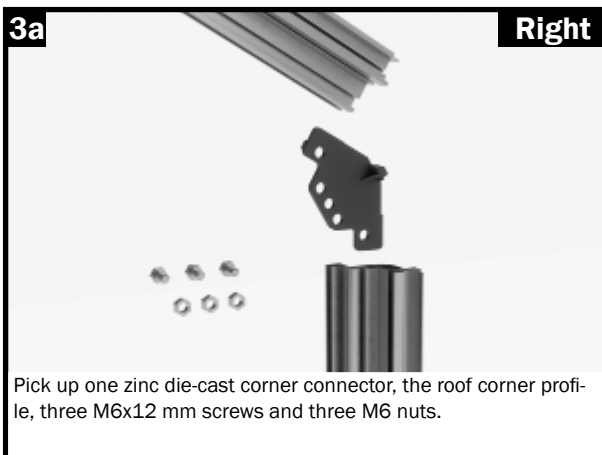
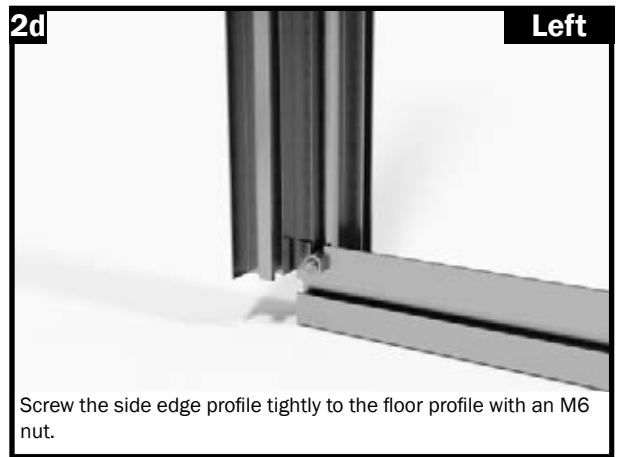
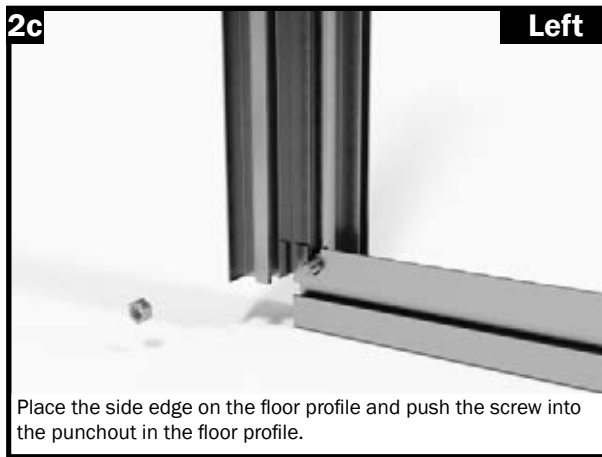
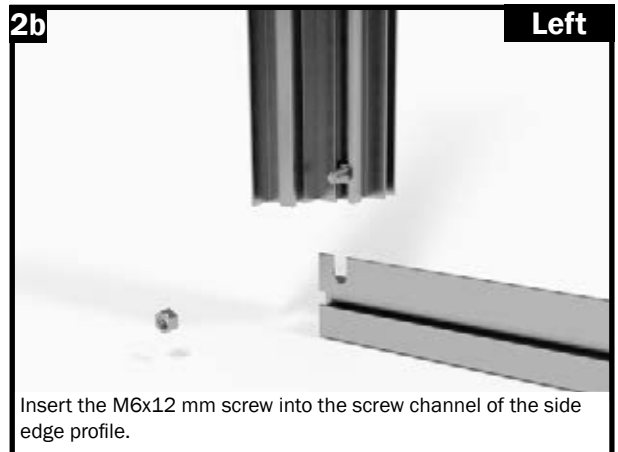
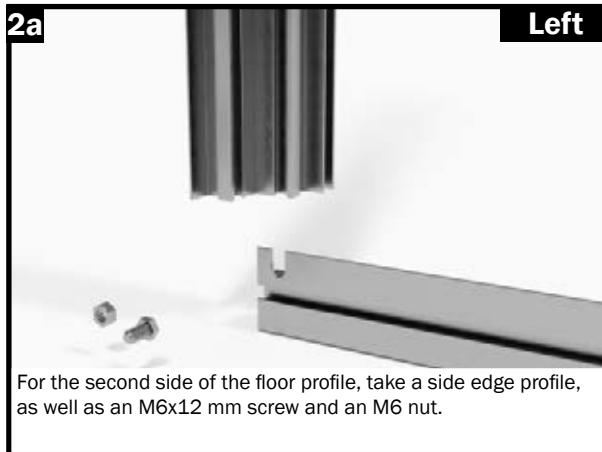

Step 2 – Assembling the rear wall

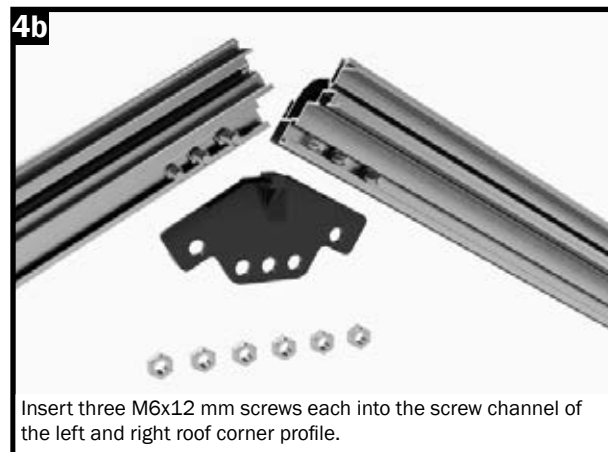
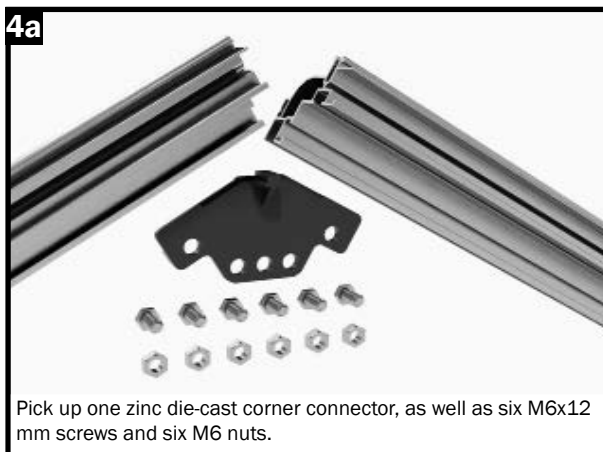
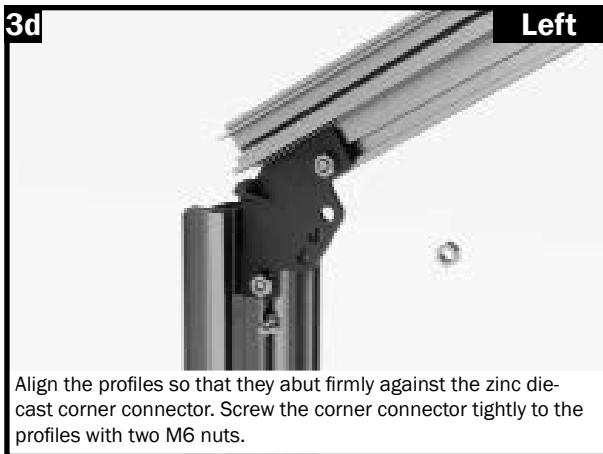
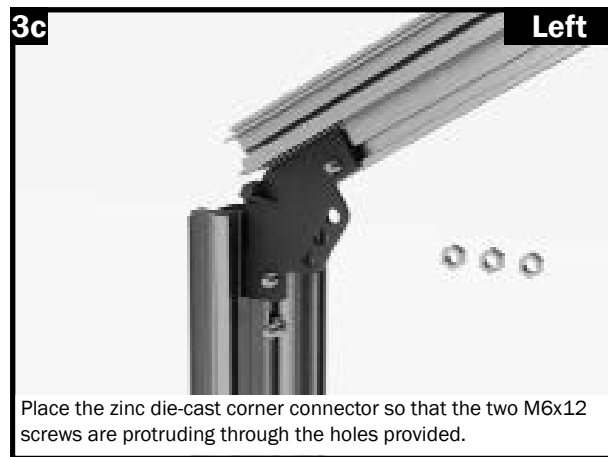
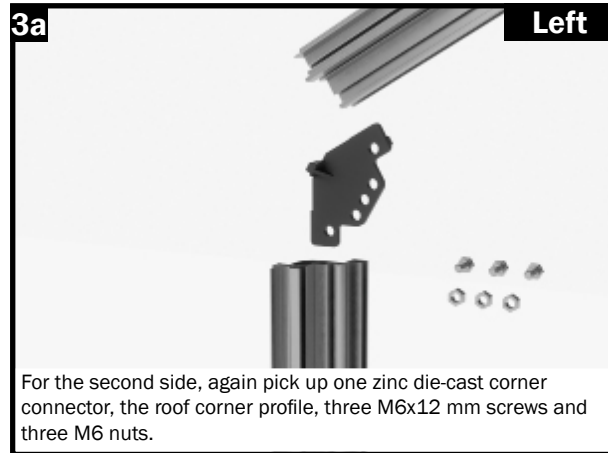
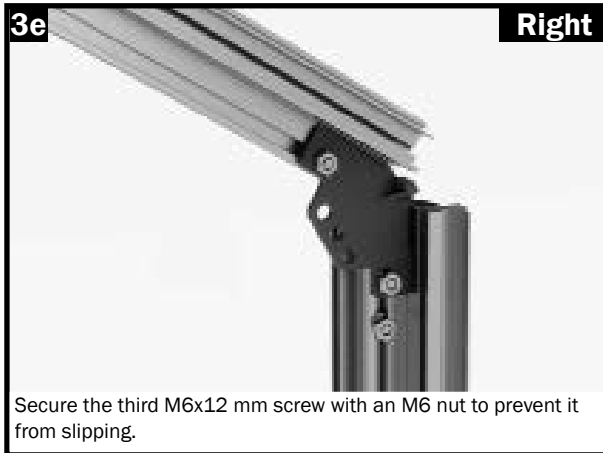

Step 2 – Assembling the rear wall

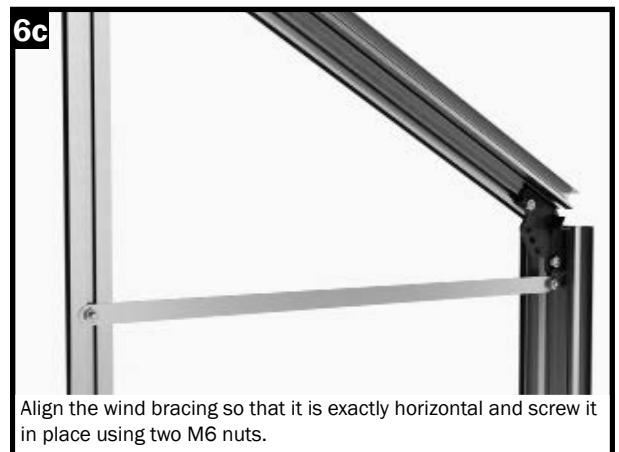
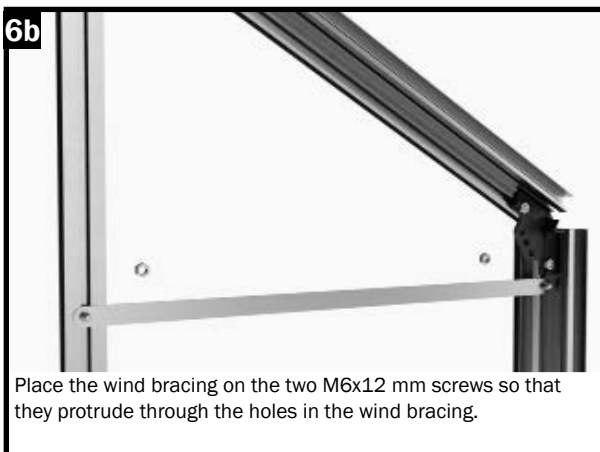
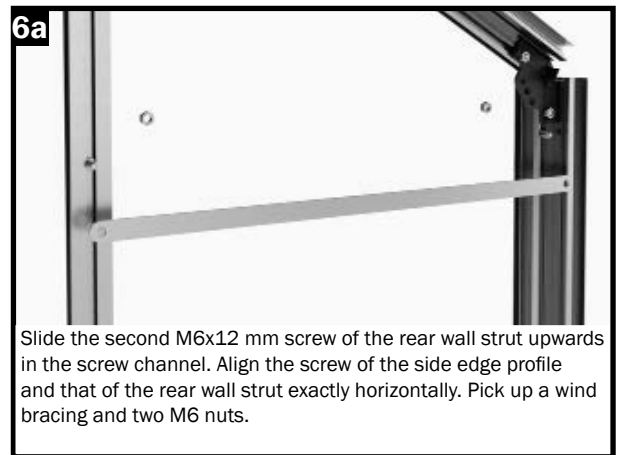
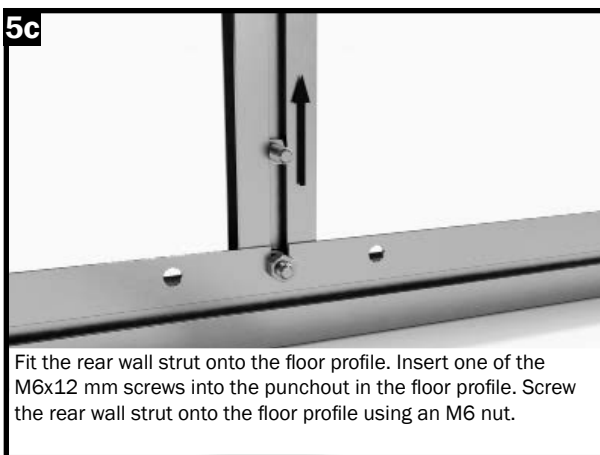
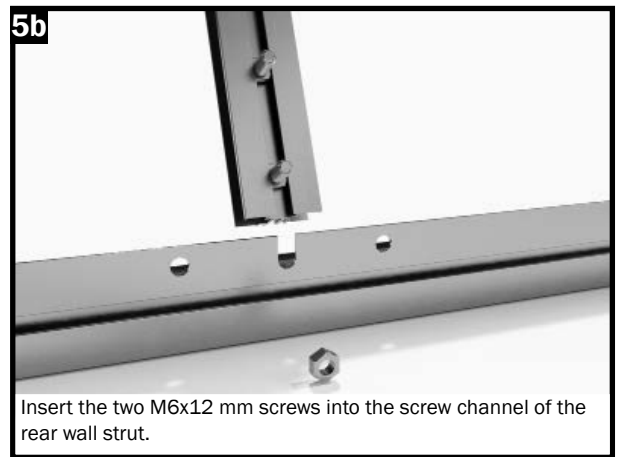
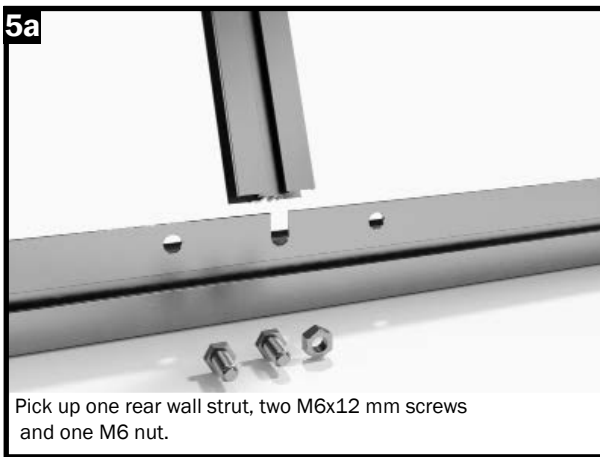
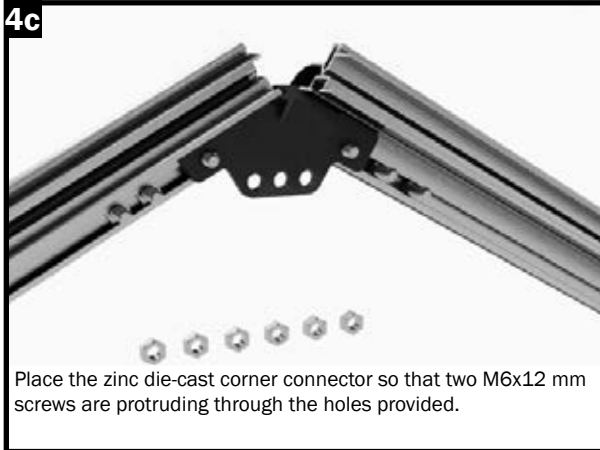

Step 2 – Assembling the rear wall

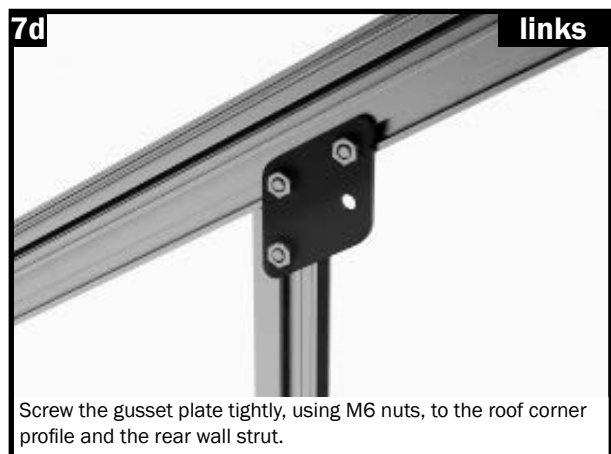
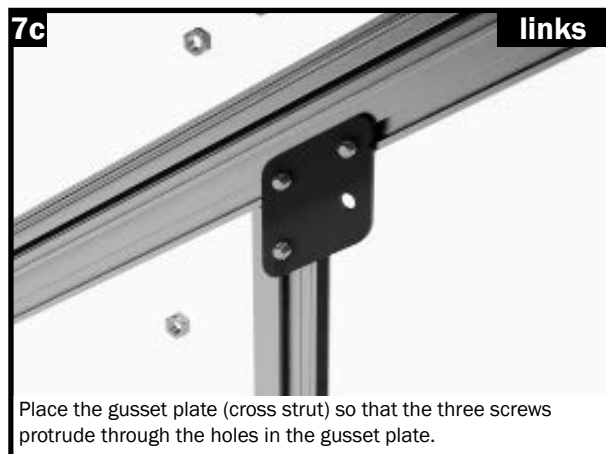
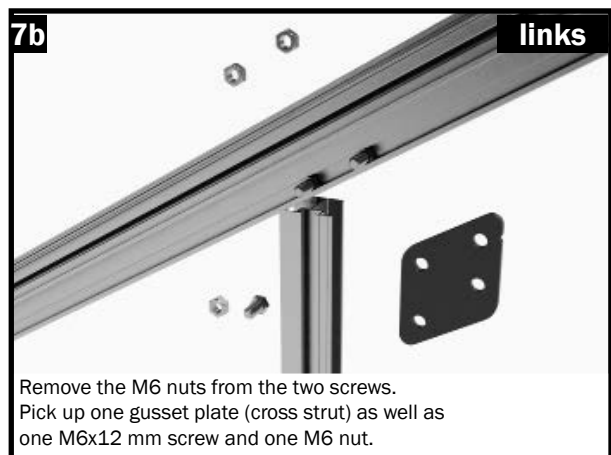
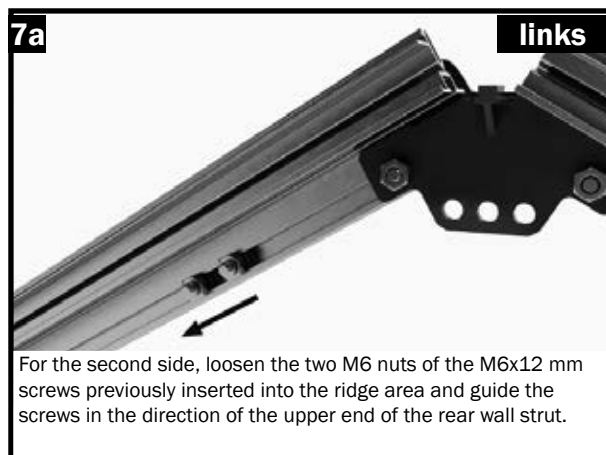
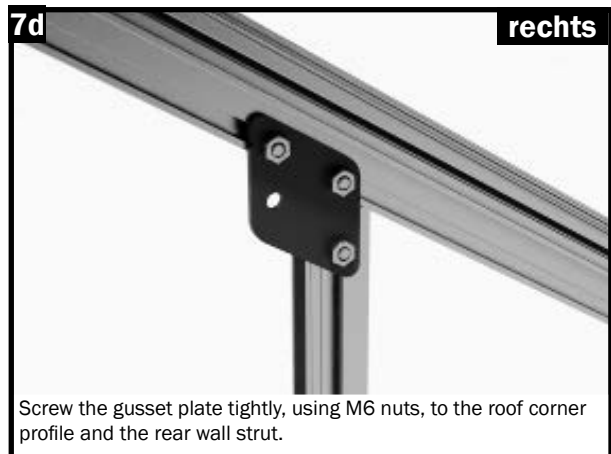
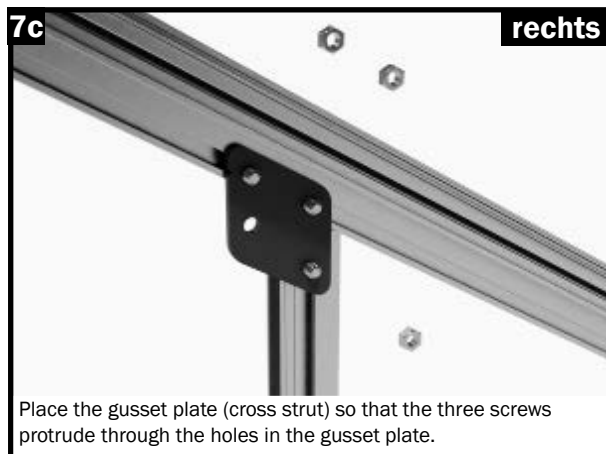
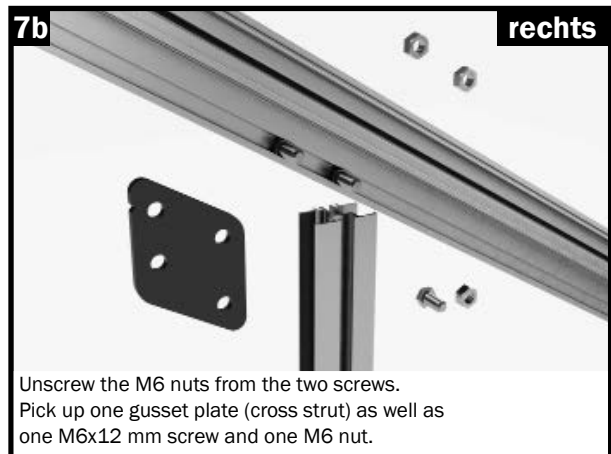
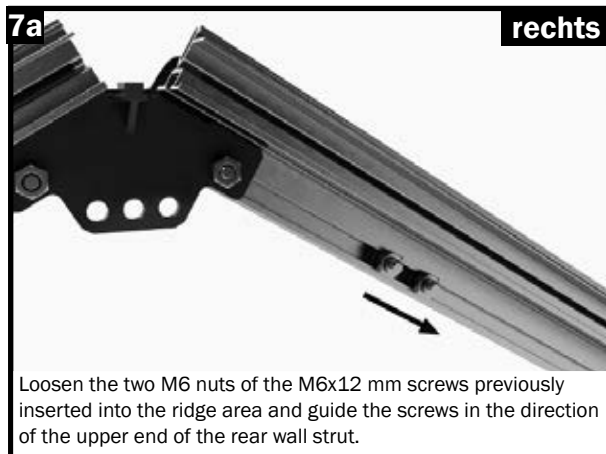

Step 2 – Assembling the rear wall

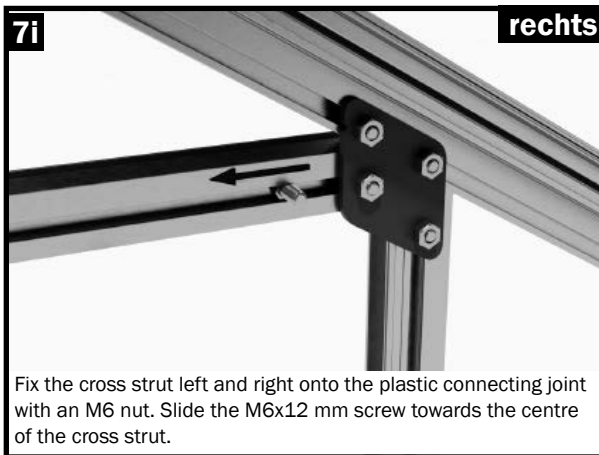
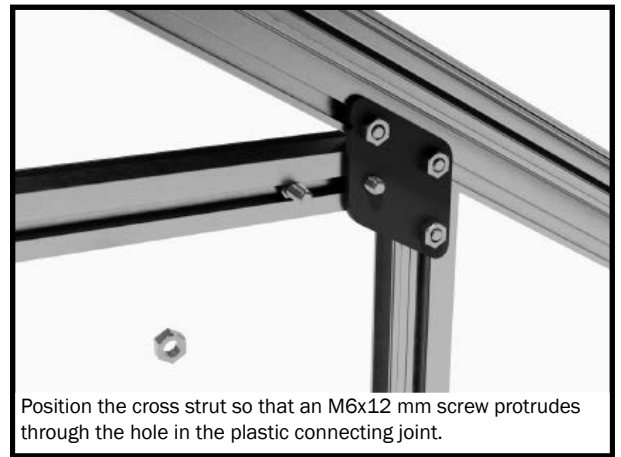
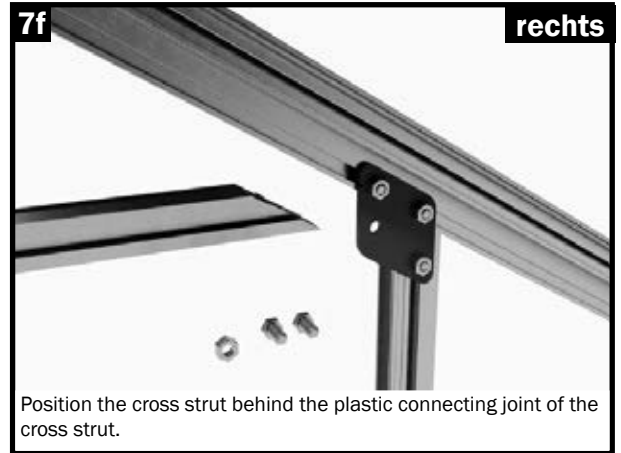
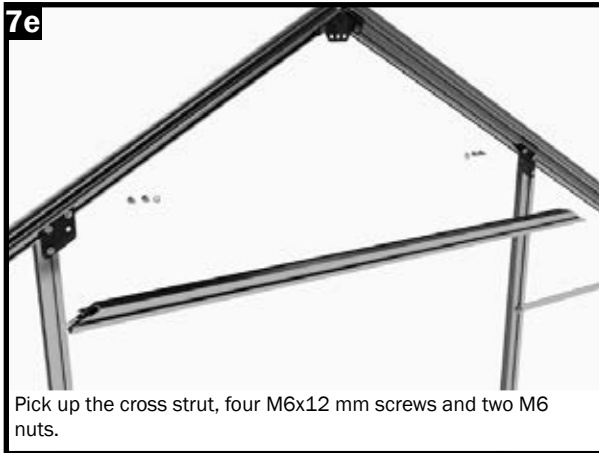

Screw the left side of the cross strut in the same way as shown in Figures 7f to 7i.

Step 2 – Assembling the rear wall (attaching the two wind bracings)

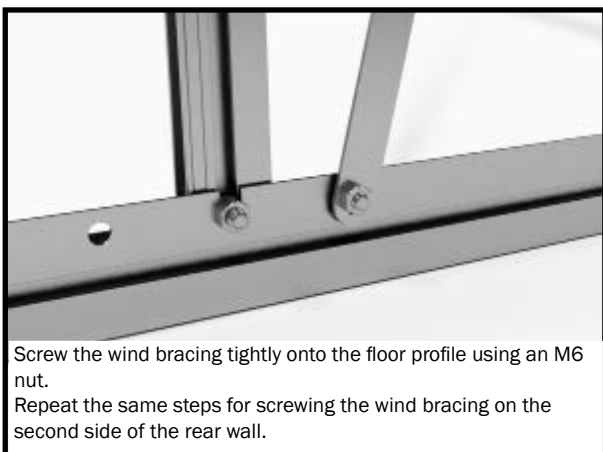
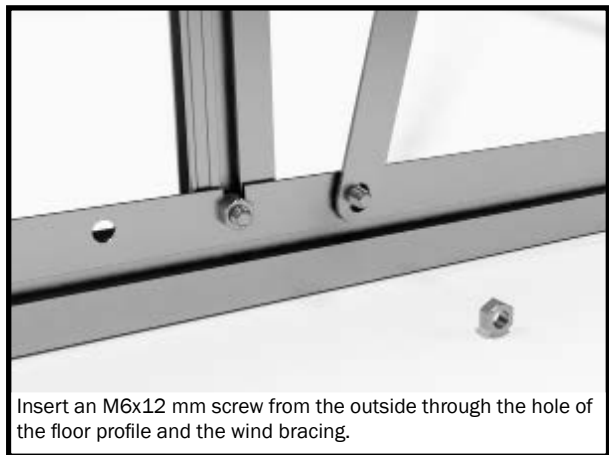
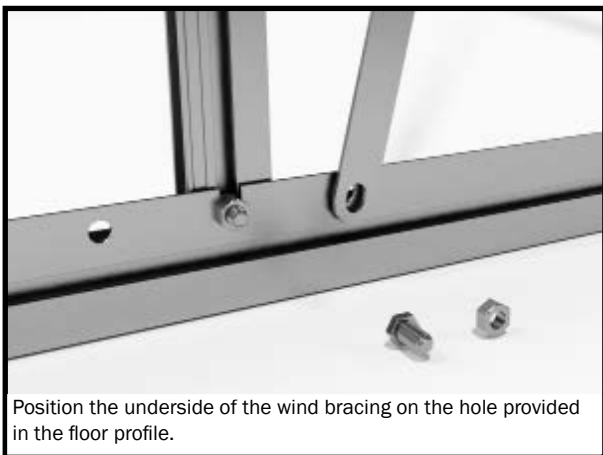
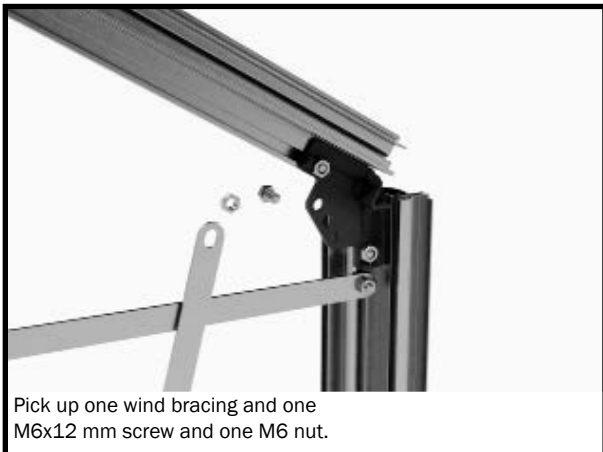

Step 2 – Assembling the rear wall (attaching the roof support)

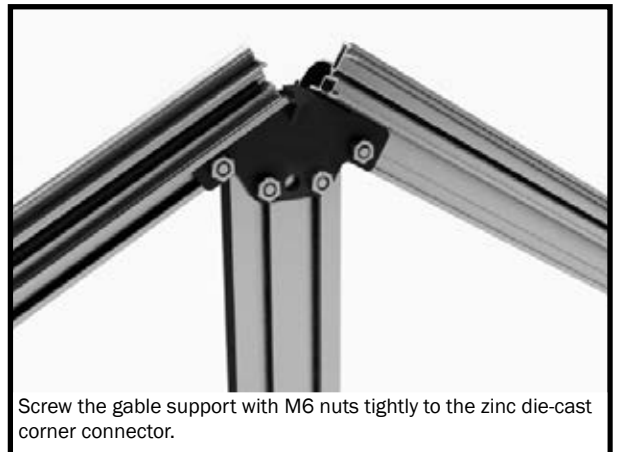
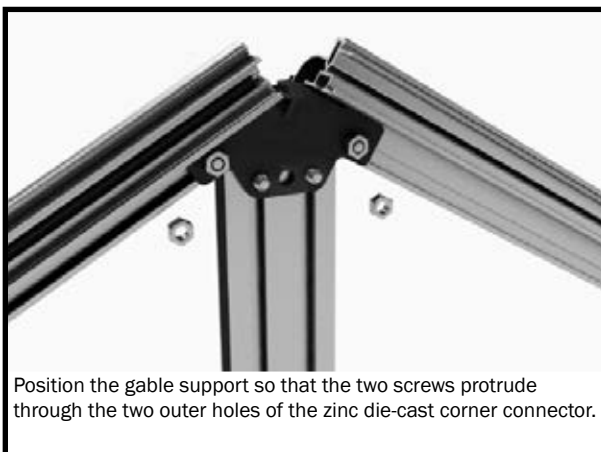
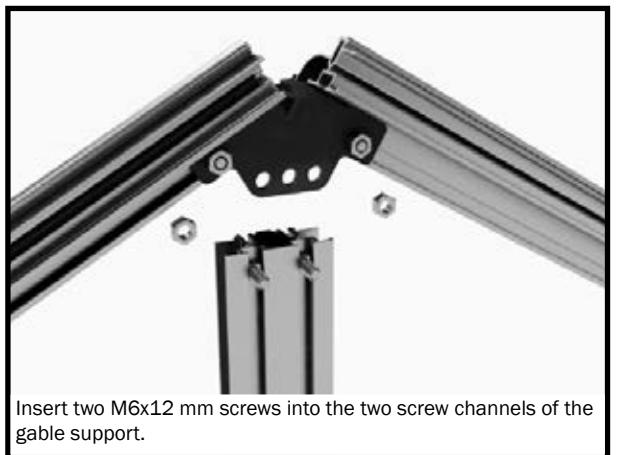
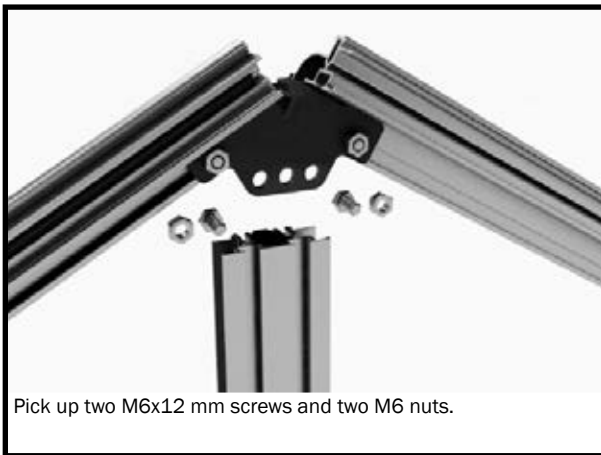
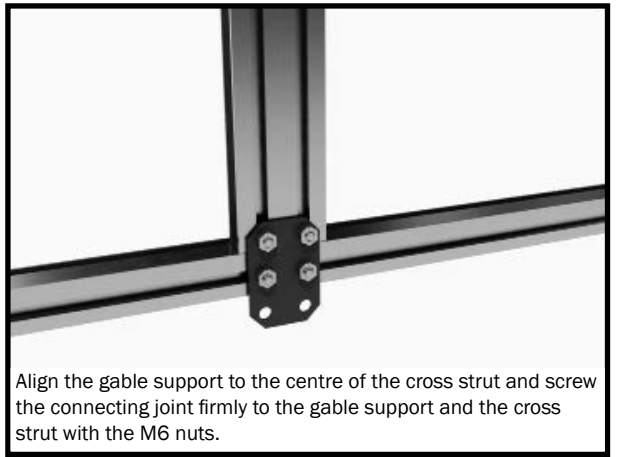
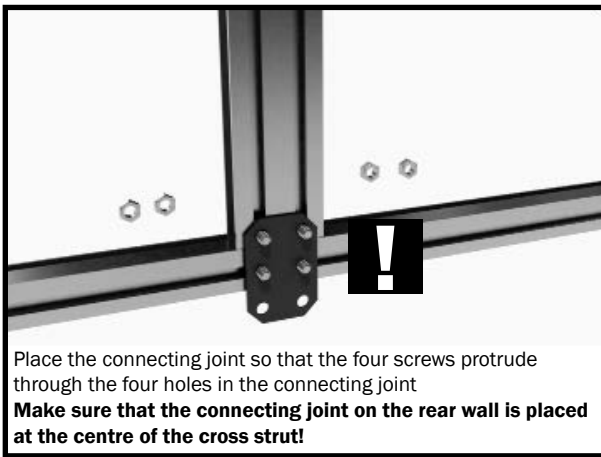

Step 2 – Assembling the rear wall (attaching the coupling strut in the middle of the rear wall)

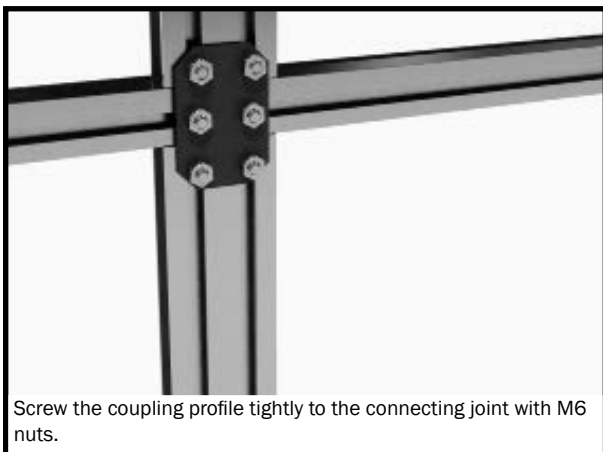
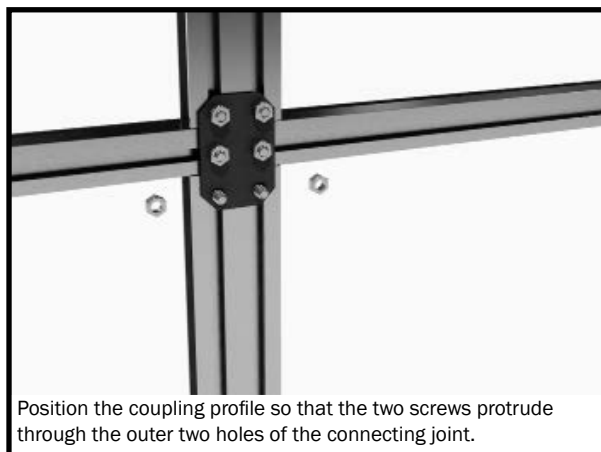
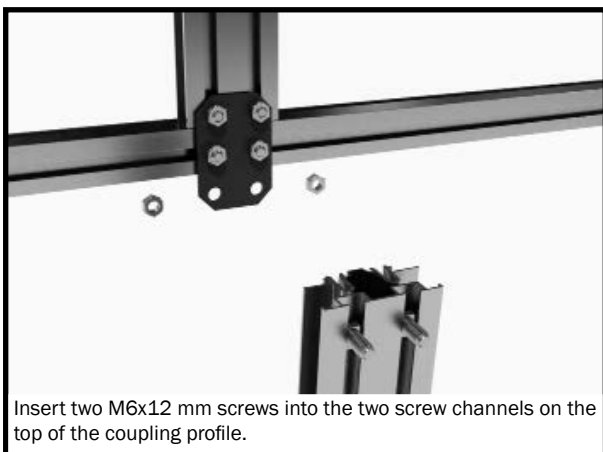
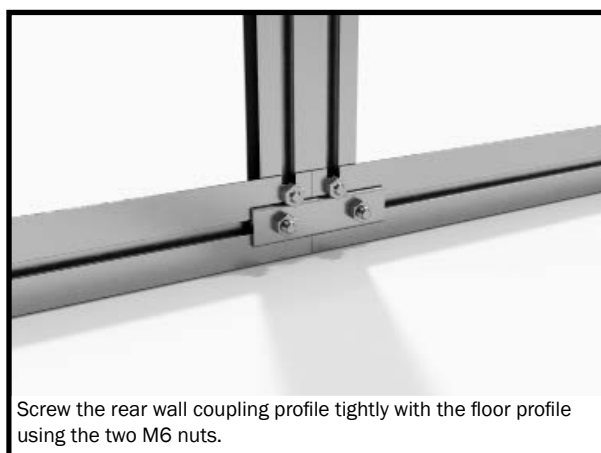
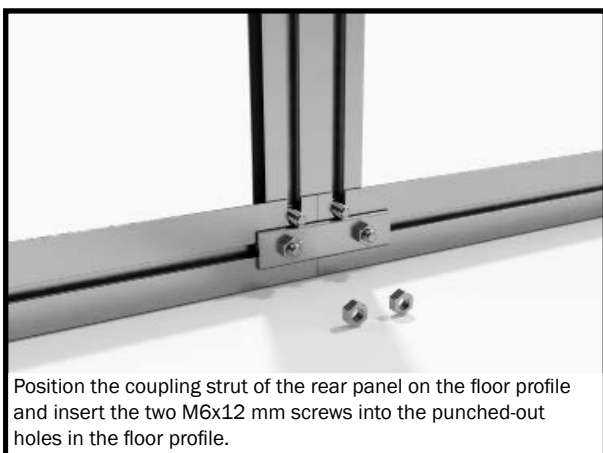
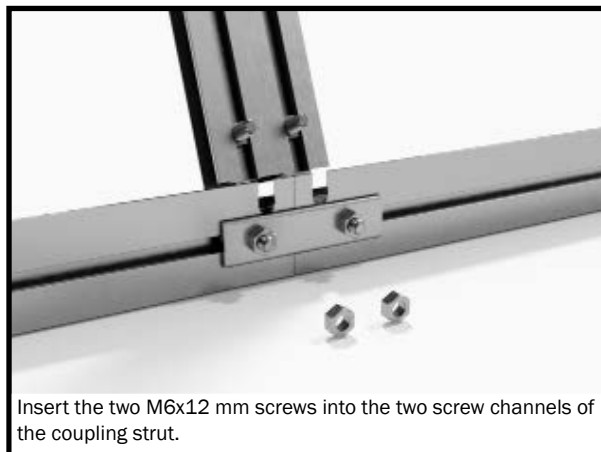
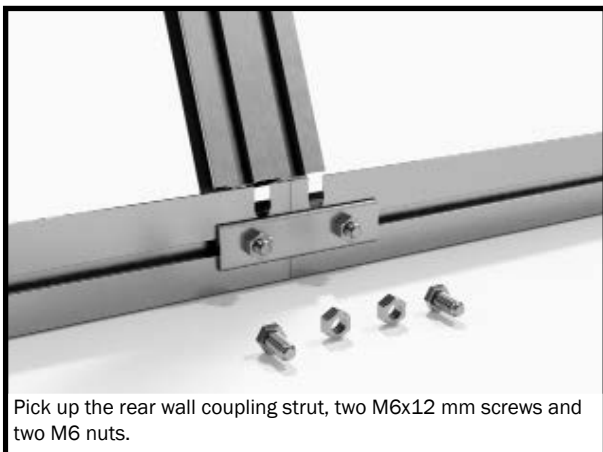

BLANK PAGE

Step 3 – Connecting the longitudinal parts (floor profile, rain gutter, ridge)

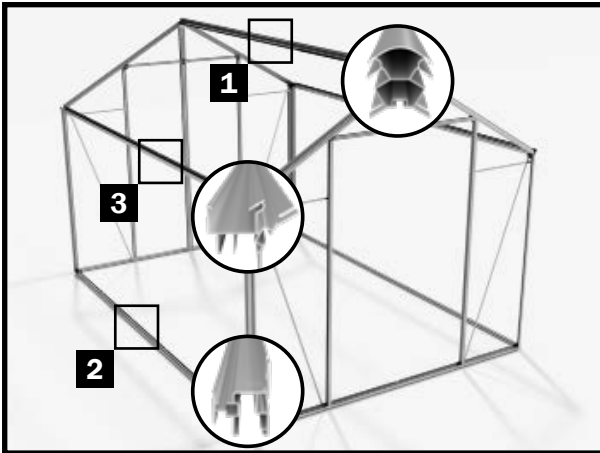

STEP 1 – Connecting the longitudinal parts

In the first step, the floor profiles, rain gutters and ridge are connected using the supplied connectors. The floor, rain gutter and ridge must all be the same length!

Note:

For the SAPHIR 2 and SAPHIR 3 models, the side floor profiles, the rain gutters and the ridge are continuous; therefore, the step “Connecting the longitudinal parts“ can be omitted.

If you have purchased the SAPHIR 2 or SAPHIR 3 model, scroll forward and continue with the assembly of the longitudinal parts. To do this, turn to page 47.

NOTE on SAPHIR 5, SAPHIR 7, SAPHIR 9

Make sure that the position of the profiles for 3 sections are in the same place for the floor profiles, rain gutters and ridge. We recommend using the longer profiles for 3 sections first.

The easiest way is to place the floor profiles and rain gutters next to each other and check that the profiles for the 3 sections are in the same position before assembly.

Please also note that the floor profiles and rain gutters must be mounted back-to-front!

Therefore, it is best to place the longitudinal profiles correctly right at the beginning, and only then begin to assemble them and screw them together.

1. It is best to start with the ridge profiles.

Fig. 1a to 1d.

2. Continue with the floor profiles.

Fig. 2a to 2d

Caution:

If you have decided to use an aluminium foundation, please follow the relevant assembly instructions on page 14.

3. Finally, connect the parts of the rain gutter.

Fig. 3a to 3e

Please make sure that a plastic connector is inserted into the rain gutters at the position where they are divided.

For this assembly step you will need:

SKETCH	PART. NO.	DESIGNATION	LENGTH	SAPHIR	SAPHIR	SAPHIR	SAPHIR	SAPHIR	SAPHIR	SAPHIR	SAPHIR
				2	3	4	5	6	7	8	9
	01-1267-1 01-1892-1	Floor profile, 2-section Floor profile, 3-section	1267 mm 1892 mm	-	-	4	2	6	4	8	6
	14-1267-1 14-1892-1	Rain gutter, 2-sector Rain gutter 3-sector	1267 mm 1892 mm	-	-	4	2	6	4	8	6
	05-1267-1 05-1892-1	Ridge, 2-sector Ridge 3-sector	1267 mm 1892 mm	-	-	2	1	3	2	4	3
	23-0070.1	Longitudinal connector	70 mm	-	-	5	5	10	10	15	15
	NG207	Plastic connector Rain gutter		-	-	2	2	4	4	6	6
	690509	M6x12 mm screw		-	-	10	10	20	20	30	30
	690547	M6 nut		-	-	10	10	20	20	30	30

Note:

If you have decided to purchase a foundation, the steps in Figures 2a to 2d – Connecting the floor profiles – have already been completed. Please see the figures on page 14.

Step 3 – Connecting the longitudinal parts (floor profile, rain gutter, ridge)

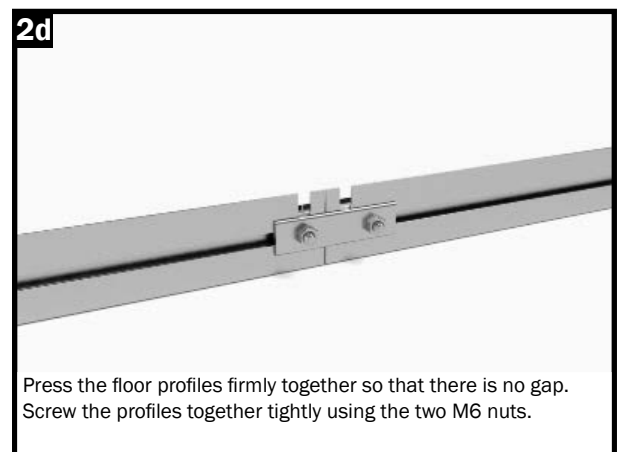
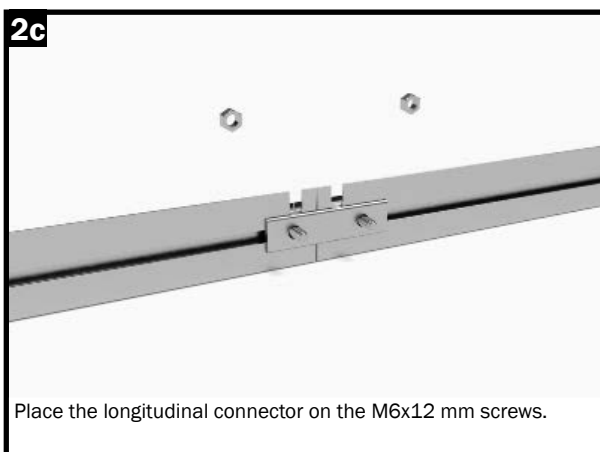
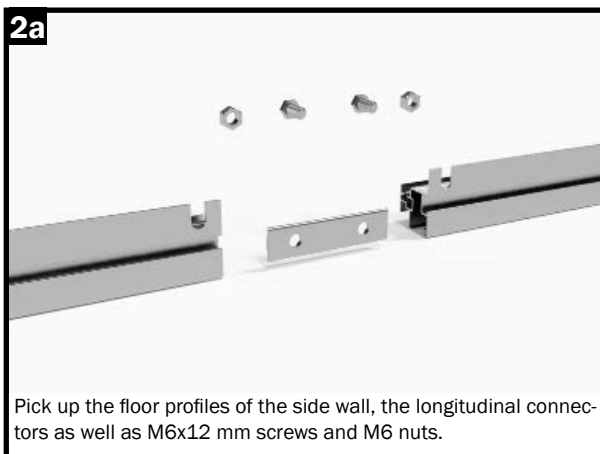
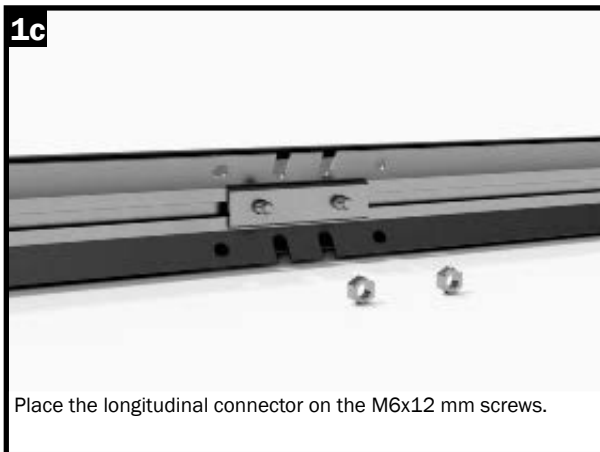



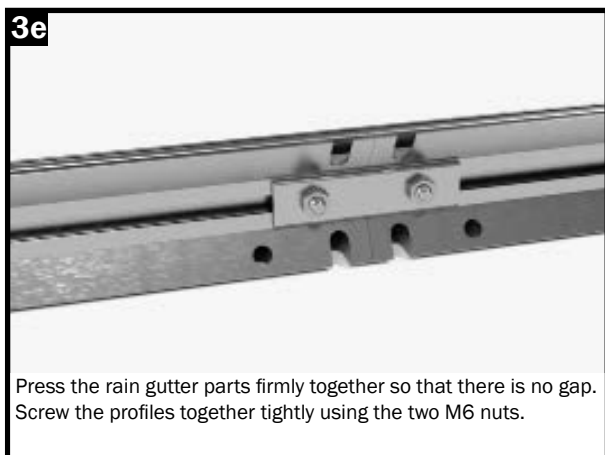
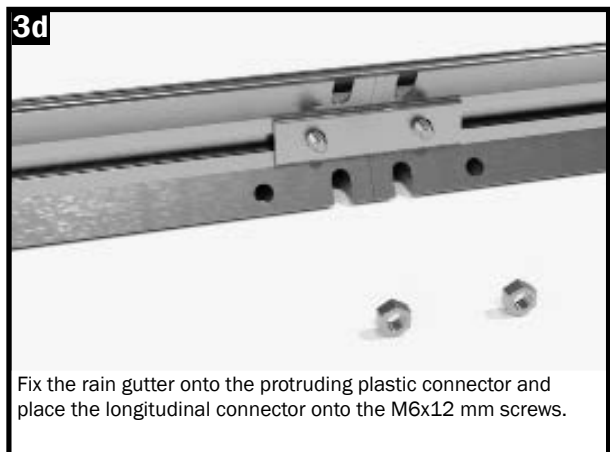
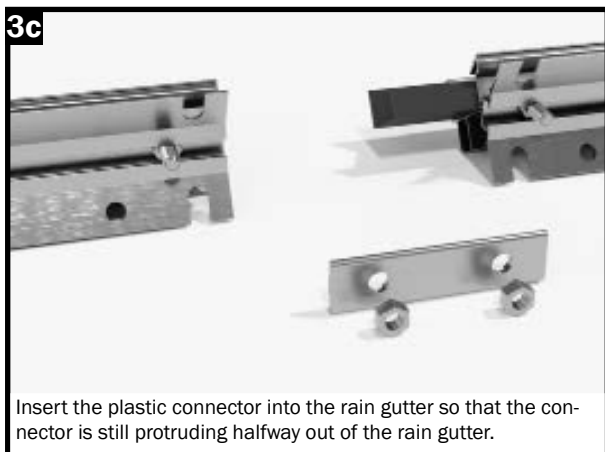

Step 3 – Connecting the longitudinal parts (floor profile, rain gutter, ridge)

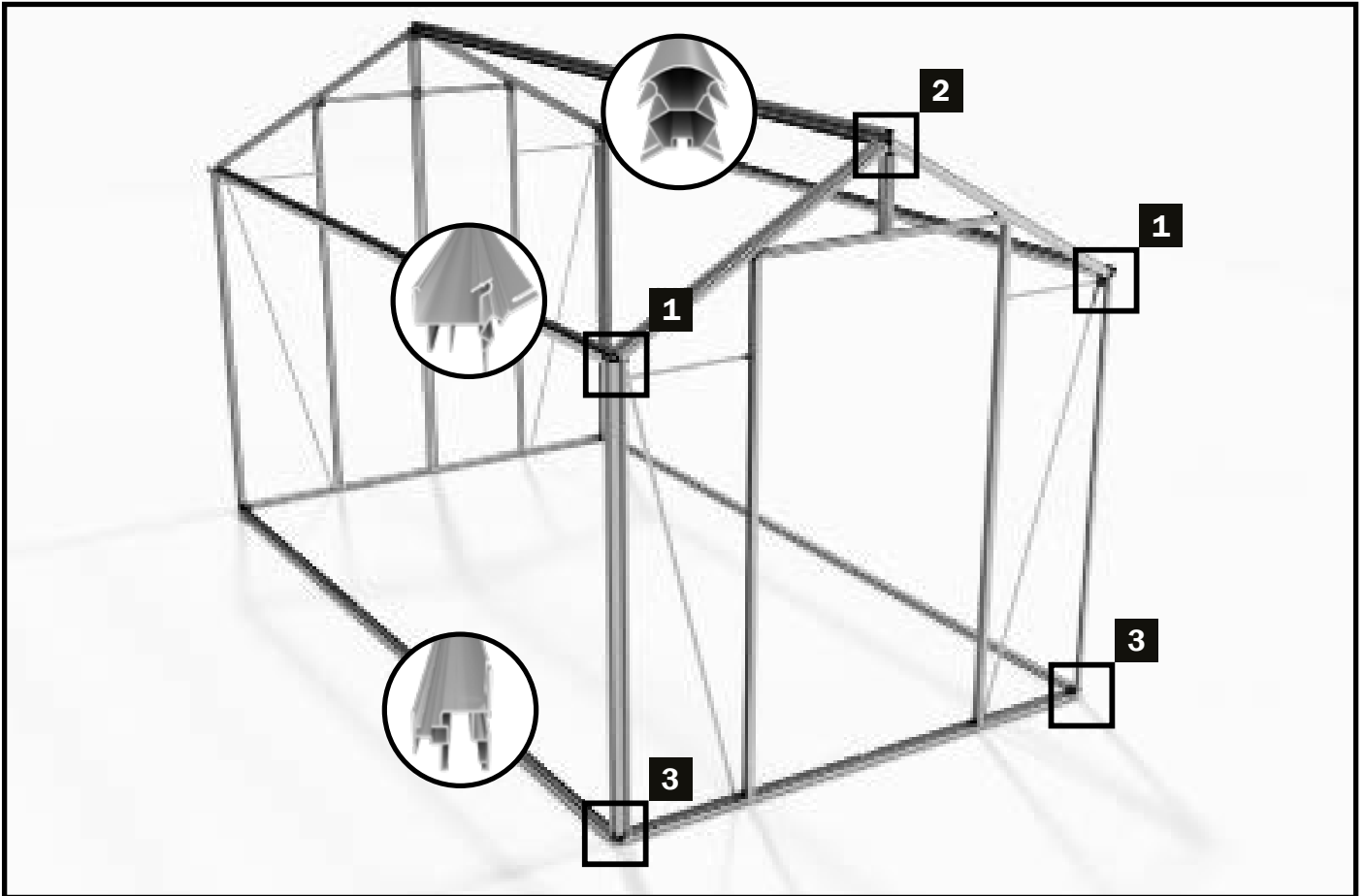

Step 4 – Assembling the longitudinal parts (floor profile, rain gutter, ridge)



For this assembly step you will need:

SKETCH	DESIGNATION	Qty.	SAPHIR 2	SAPHIR 3	SAPHIR 4	SAPHIR 5	SAPHIR 6	SAPHIR 7	SAPHIR 8	SAPHIR 9
	Floor profile (already prepared)	2	1267 mm	1892 mm	2534 mm	3159 mm	3801 mm	4426 mm	5068 mm	5693 mm
	Rain gutter (already prepared)	2	1267 mm	1892 mm	2534 mm	3159 mm	3801 mm	4426 mm	5068 mm	5693 mm
	Ridge (already prepared)	1	1267 mm	1892 mm	2534 mm	3159 mm	3801 mm	4426 mm	5068 mm	5693 mm
	690509 M6x12 mm screw	24								
	690547 M6 nut	24								

STEP 1 – Assembling the longitudinal parts

In the next step, the longitudinal parts (floor profiles, rain gutters and the ridge) are screwed onto the prepared front and rear walls.

This work should be done by at least two people, but ideally by three.

Place the longitudinal parts on the floor. Set up the front or rear wall so that the longitudinal parts indicated the required distance between the front and rear walls.

Start by screwing down the rain gutters, then insert the ridge profile. Finally, the two floor profiles are screwed together with the front and rear walls.

Note:

The screw connections are exactly the same on the front and rear walls. Screw the part tightly to the front wall first, then to the rear wall. Assemble the next part only after both sides have been screwed together!

Step 4 – Assembling the longitudinal parts (floor profile, rain gutter, ridge)

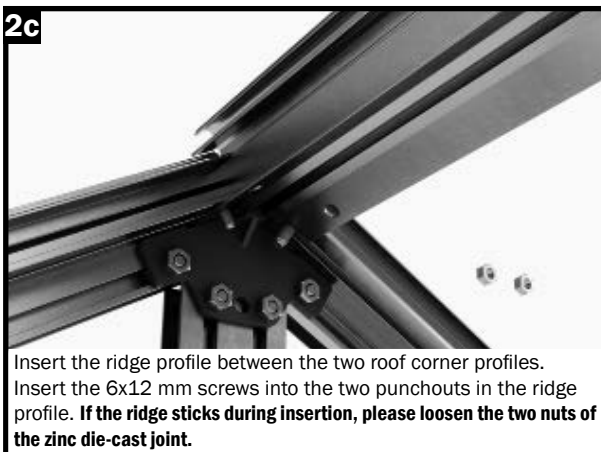
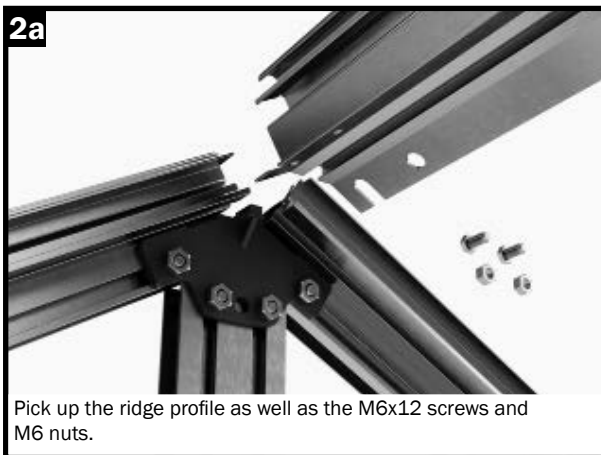
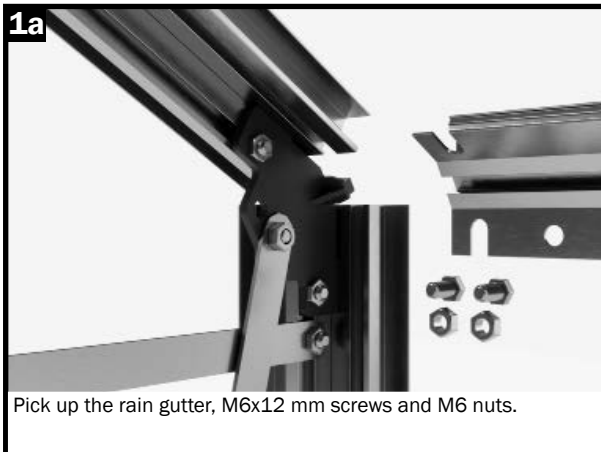

Step 4 – Assembling the longitudinal parts (floor profile, rain gutter, ridge)

Note:

If you have decided to purchase a foundation, the steps in Figures 3a to 3g – Connecting the floor profiles – have already been completed.

Please see the figures starting on page 14.

3a

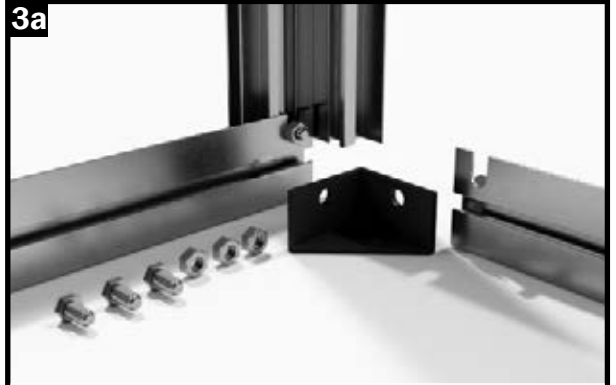

Pick up the floor profile as well as M6x12 mm screws, M6 nuts and the floor joint made of plastic.

3b

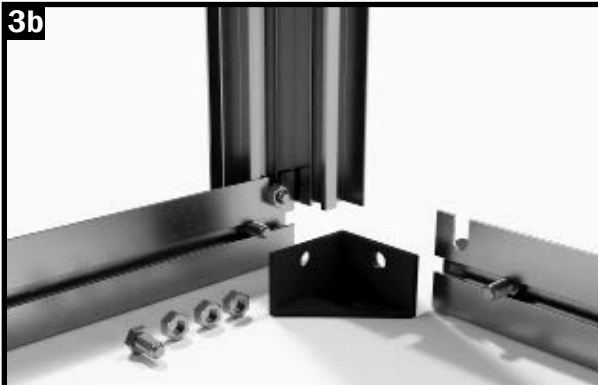

Insert one M6x12 mm screw each into the screw channel of the floor profile of the front and side walls.

3c

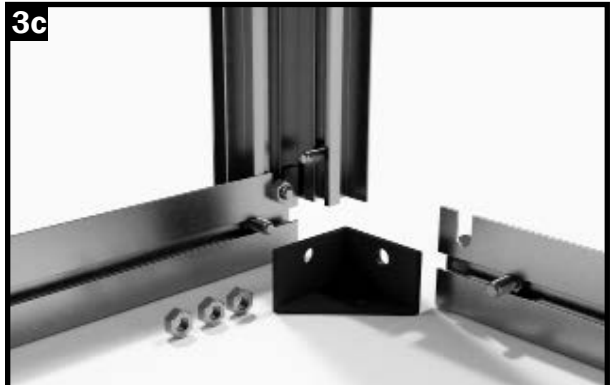

Insert an M6x12 mm screw into the screw channel of the side edge profile.

3d

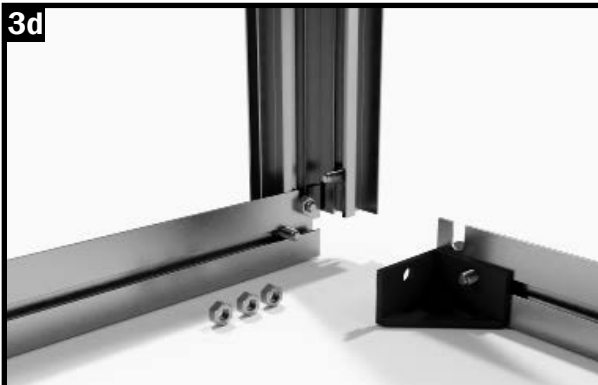

Place the plastic corner of the floor profile on the M6x12 mm screw of the side floor profile.

3e

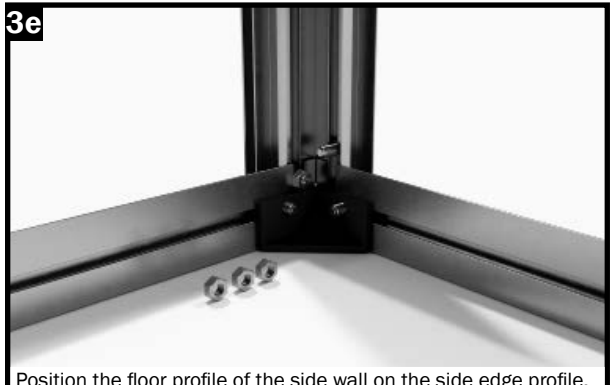

Position the floor profile of the side wall on the side edge profile. Align the M6x12 mm screw so that it protrudes through the hole in the floor joint.

3f



Insert the M6x12 mm screw of the side edge profile into the punchout of the floor profile and screw it tightly with an M6 nut.

3g



Align the floor joint so that it is positioned exactly in the corner of the floor profiles. Screw the floor joint tightly to the floor profiles with two M6 nuts.

Step 5 – Assembling the coupling profiles

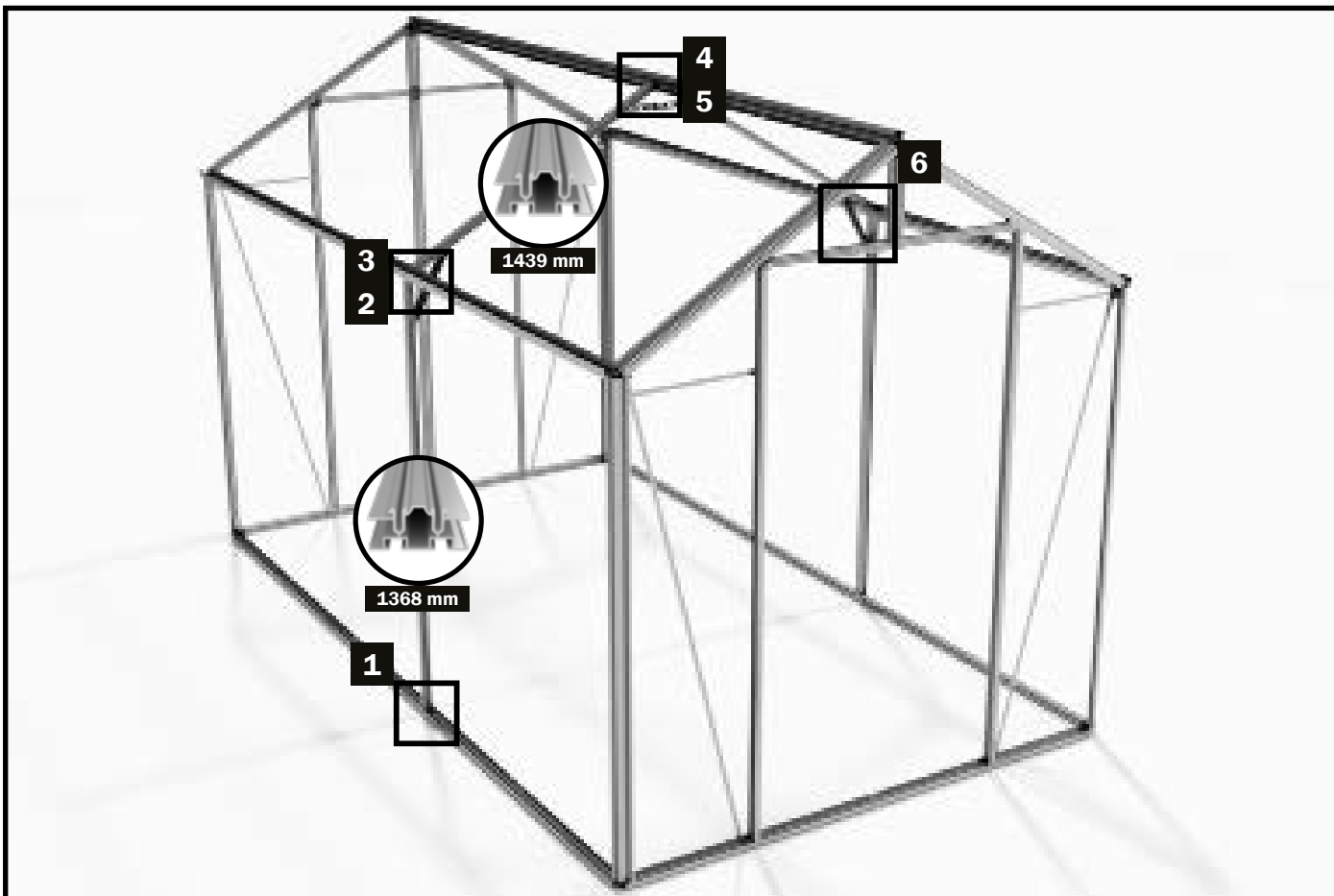

For this assembly step you will need:

SKETCH	PART. NO.	DESIGNATION	LENGTH	SAPHIR 2	SAPHIR 3	SAPHIR 4	SAPHIR 5	SAPHIR 6	SAPHIR 7	SAPHIR 8	SAPHIR 9
	13-1368.1	Coupling strut, sidewall	1368 mm	-	-	2	2	4	4	6	6
	13-1439.1	Coupling strut, roof	1439 mm	-	-	2	2	4	4	6	6
	126-0025.1	Brace for ridge and rain gutter	25 mm	-	-	3	3	6	6	9	9
	690509	M6x12 mm screw		-	-	22	22	44	44	66	66
	690547	M6 nut		-	-	22	22	44	44	66	66

TEP 7 – Assembling the coupling struts

In the following assembly phase, the coupling struts are mounted on the side walls and the roof.

Please note that the longitudinal profiles (ridge, rain gutters and floor profiles) are not yet divided for the SAPHIR 2 and SAPHIR 3 models.

If you have purchased a SAPHIR 2 or SAPHIR 3 model, this assembly step is not necessary.

Please scroll forward to the point “Assembly of the side wall and roof struts“ on page 54.

Step 5 – Assembling the coupling profiles

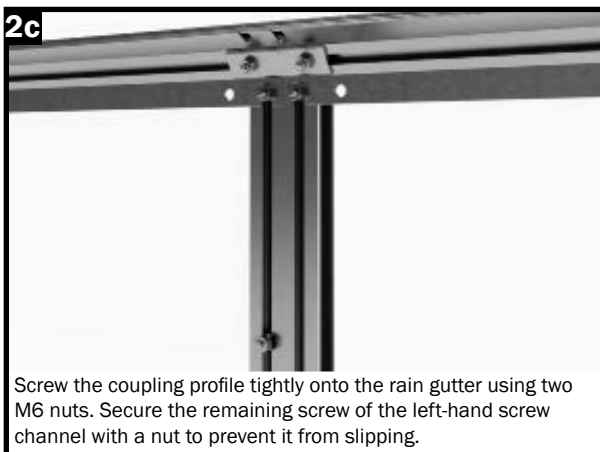
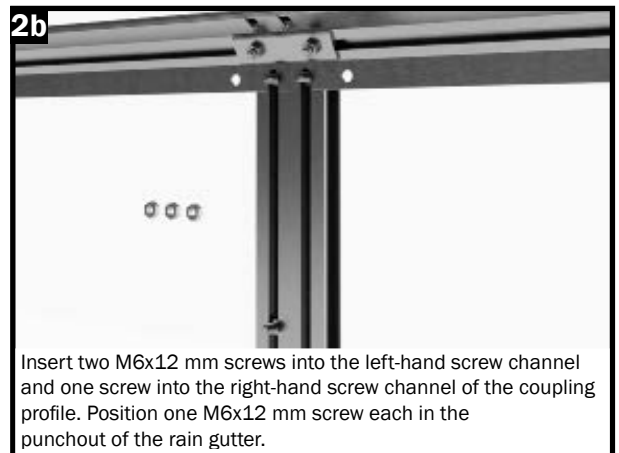
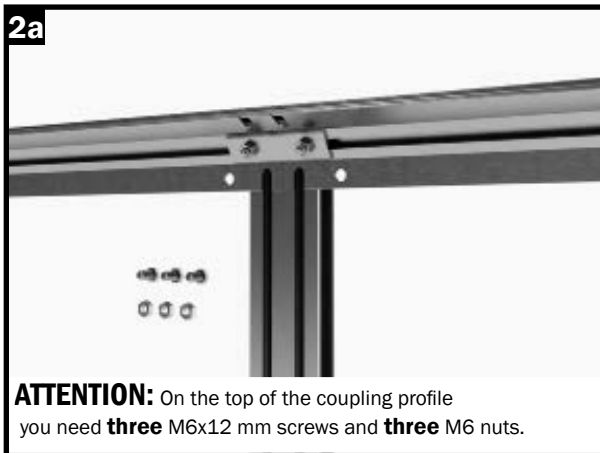
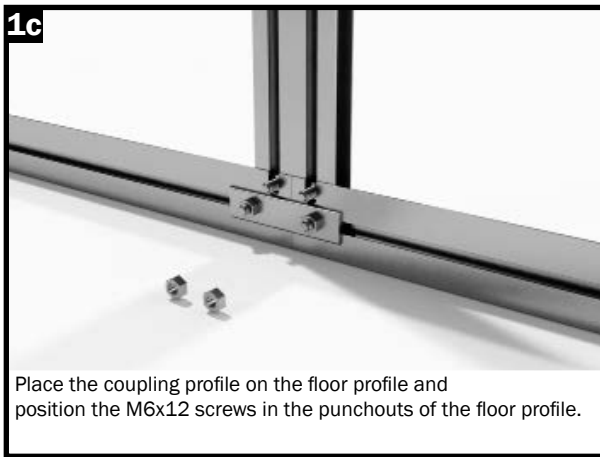
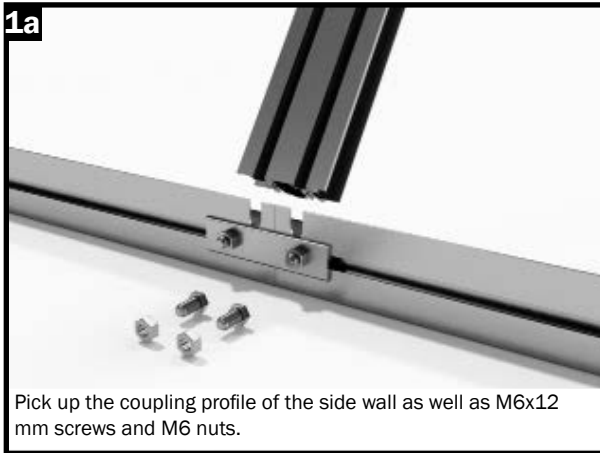

Step 5 – Assembling the coupling profiles

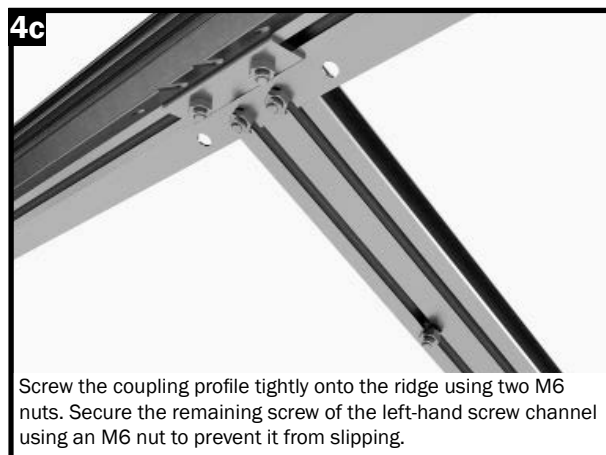
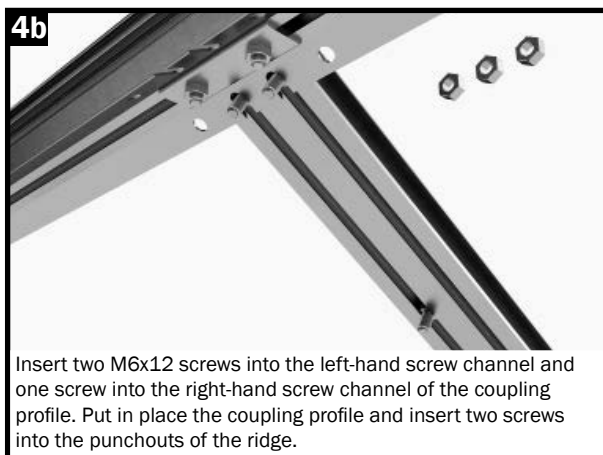
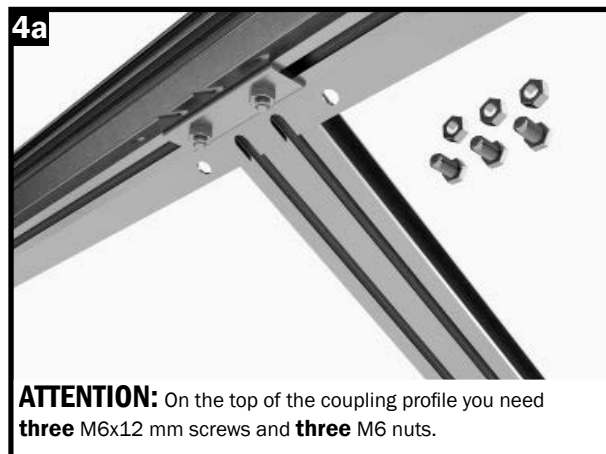
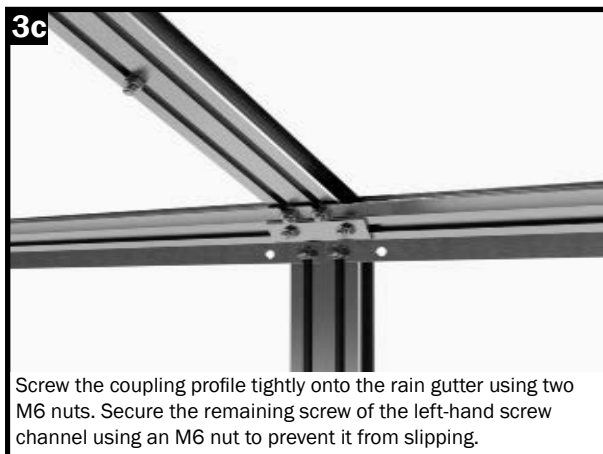
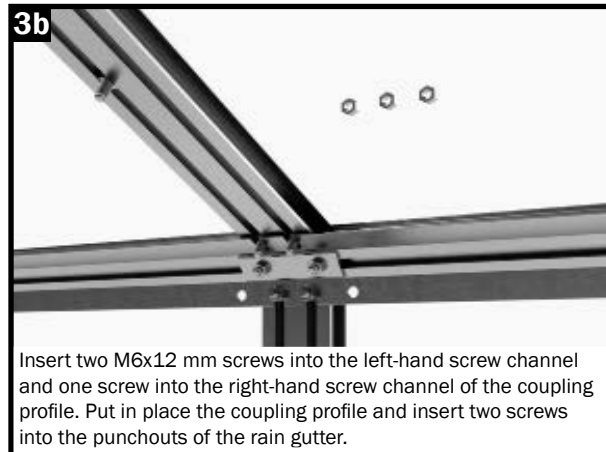
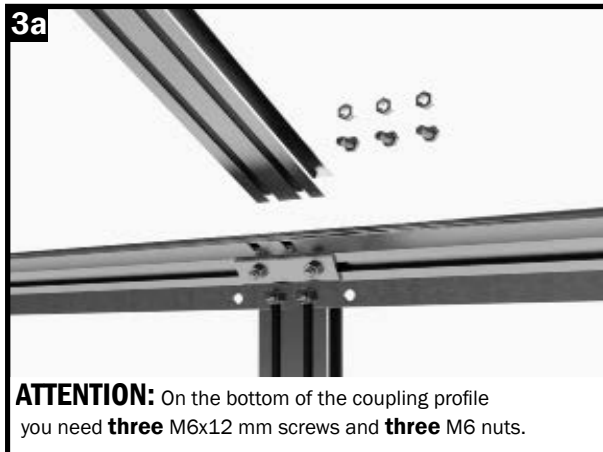

NOTE: Assembling the brace for ridge and rain gutter

To further improve the roof loads of our greenhouses, we have included additional braces for the areas where the longitudinal profiles (ridge profile and rain gutter) are divided.

Please install one brace each on the ridge partition and one on each of the two rain gutters.

Tip:

In order to achieve the best stability, we recommend that you slightly span the ridge outwards with an auxiliary support before installing the braces.

When mounting the braces on the rain gutters, please make sure that the rain gutters are aligned exactly straight, but under no circumstances bend outwards!

It is best to remove the support of the ridge only after the greenhouse has been glazed!



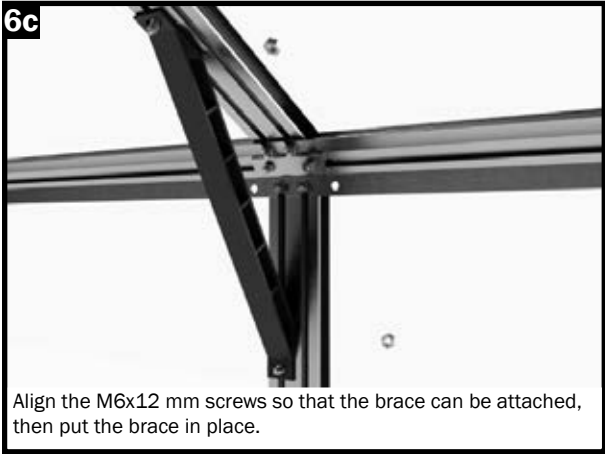
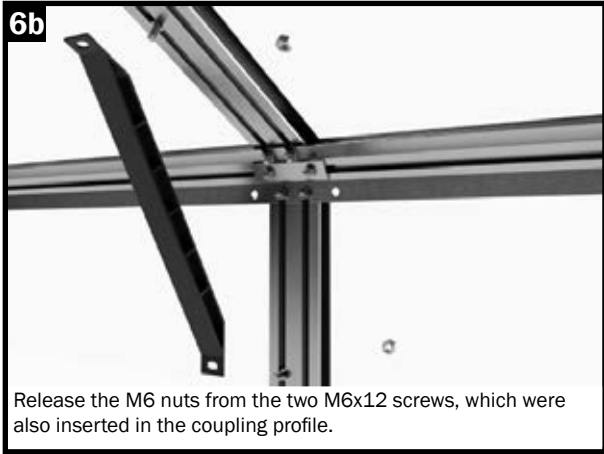
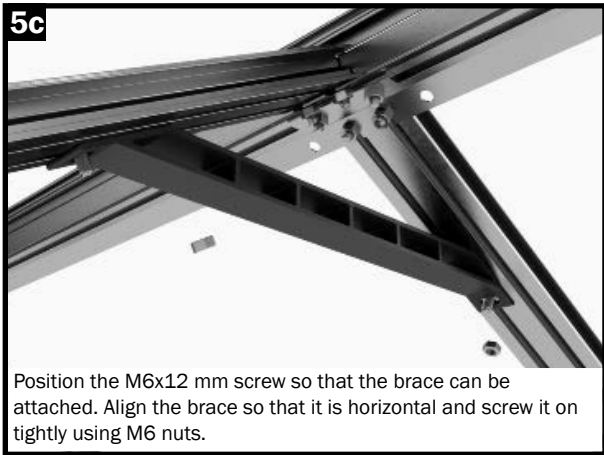
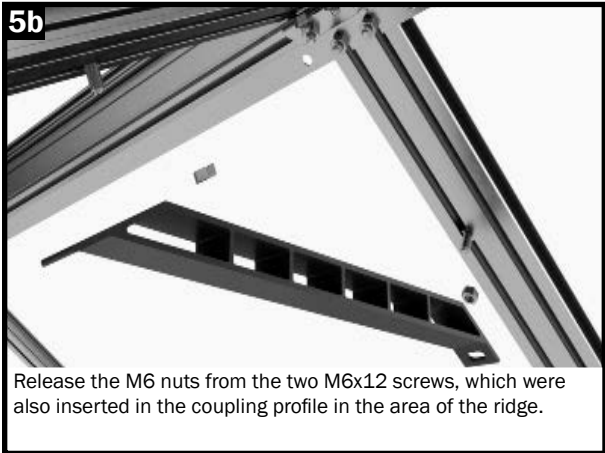
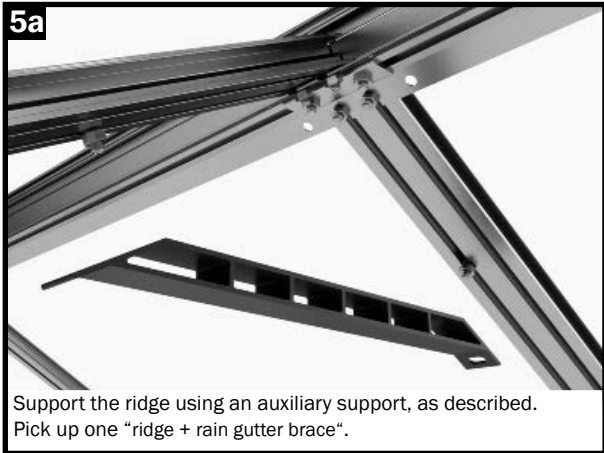

Step 5 – Assembling the coupling profiles (ridge +rain gutter brace)

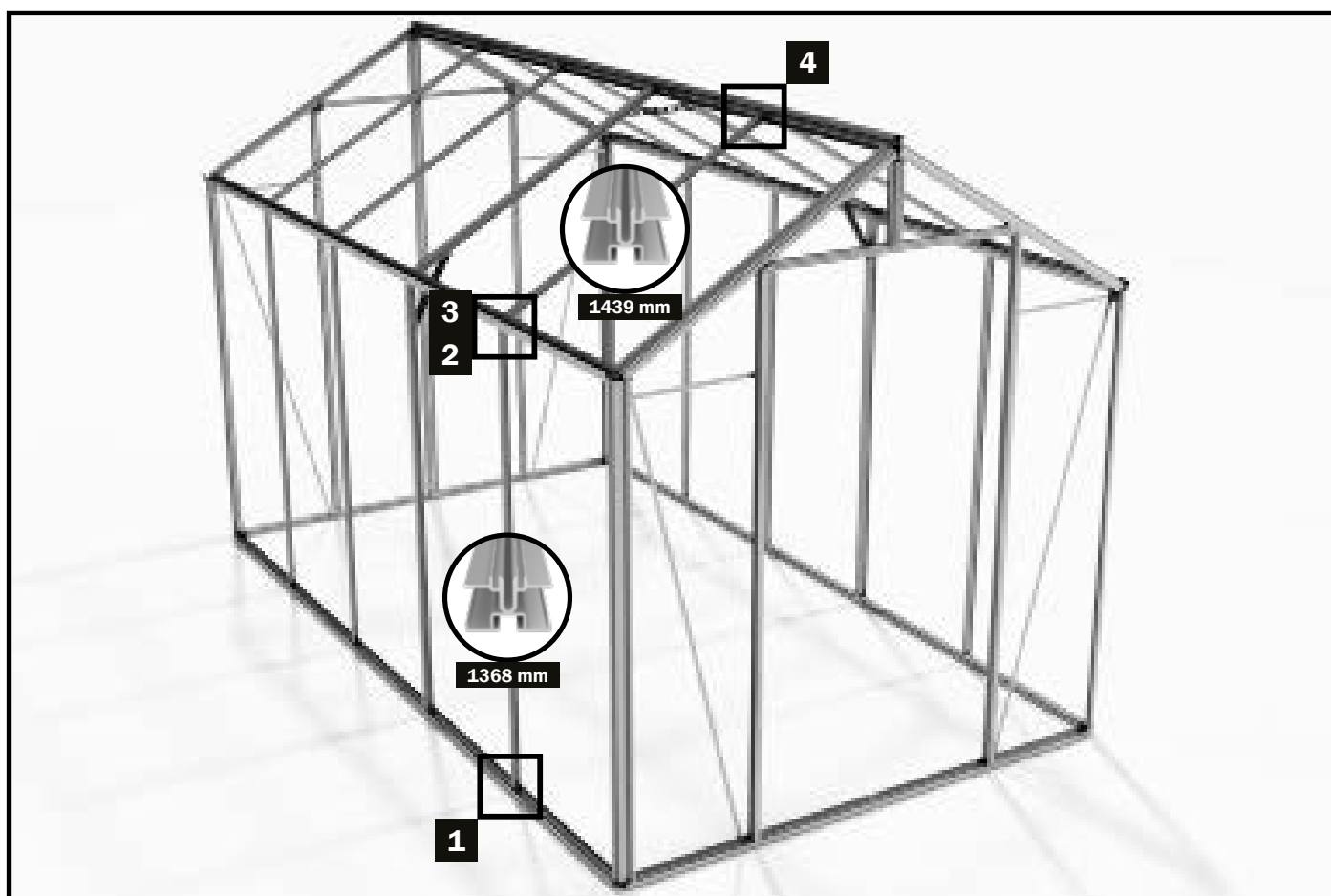

Step 6 – Assembling the side wall and roof struts



For this assembly step you will need:

SKETCH	PART. NO.	DESIGNATION	LENGTH	SAPHIR 2	SAPHIR 3	SAPHIR 4	SAPHIR 5	SAPHIR 6	SAPHIR 7	SAPHIR 8	SAPHIR 9
	12-1368.1	Side wall strut	1368 mm	2	4	4	6	6	8	8	10
	12-1439.1	Roof strut	1439 mm	2	4	4	6	6	8	8	10
	690509	M6x12 mm screw		8	16	16	24	24	32	32	40
	690547	M6 nut		8	16	16	24	24	32	32	40

Step 6 – Assembling the side wall and roof struts

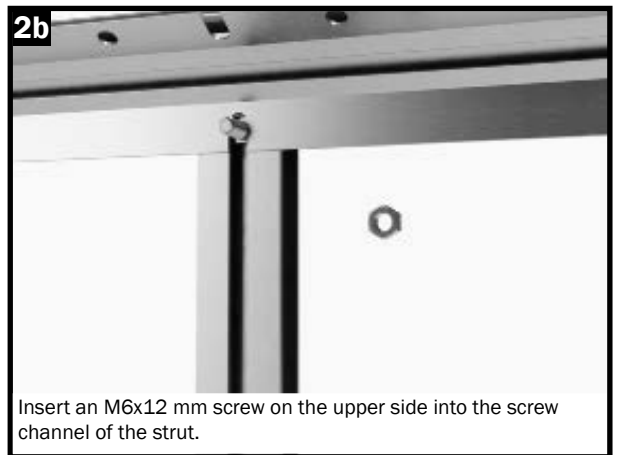
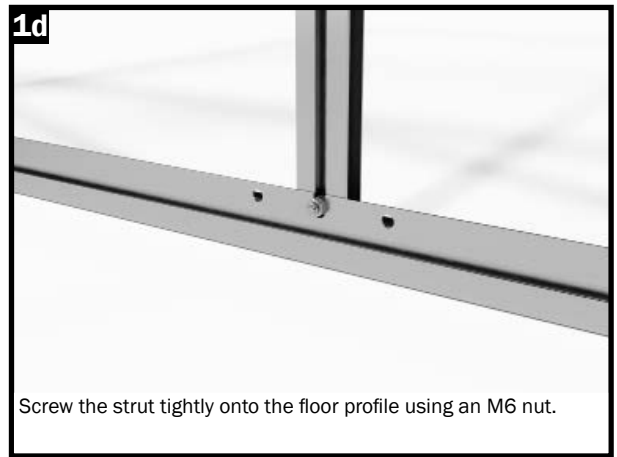
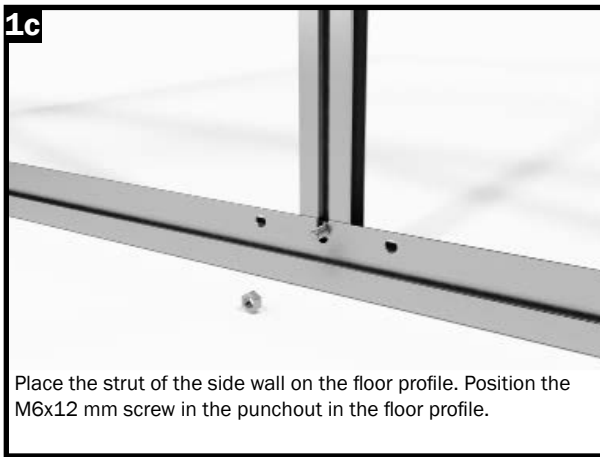
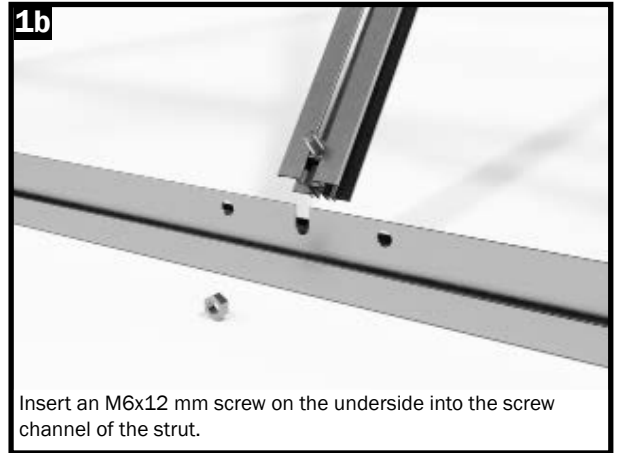
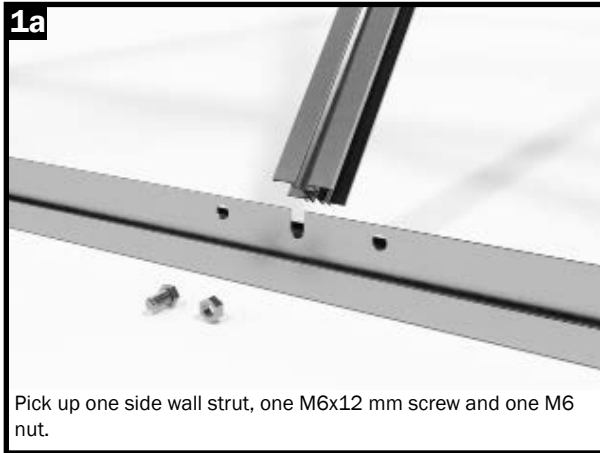

Step 6 – Assembling the side wall and roof struts

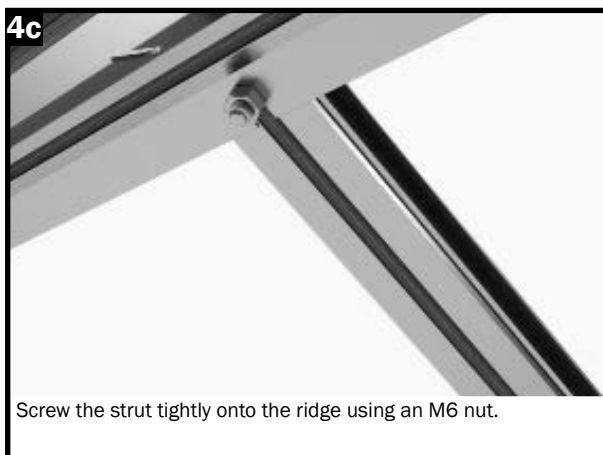
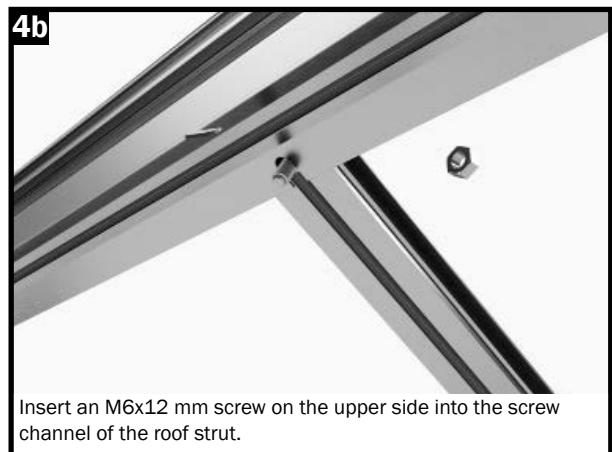
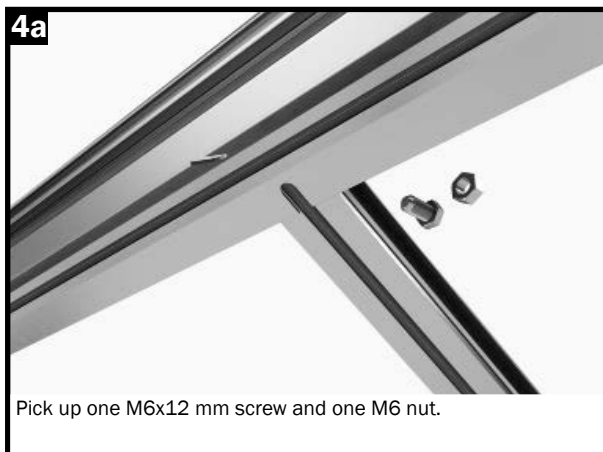



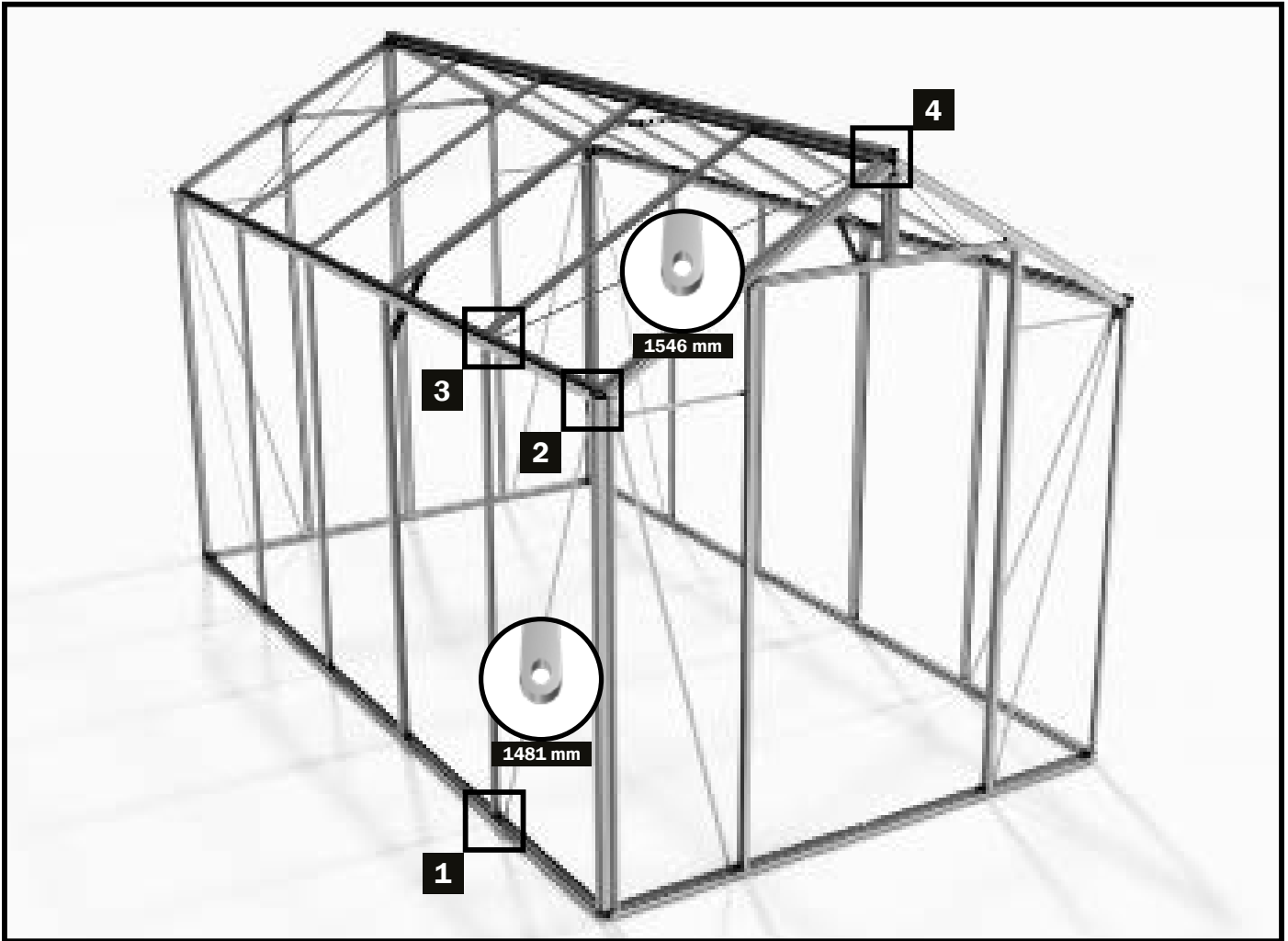

Perform the individual assembly steps for all other struts for the side wall and the roof.

Step 7 – Assembling the wind bracings on the side walls and roof



For this assembly step you will need:

SKETCH	PART. NO.	DESIGNATION	LENGTH	SAPHIR 2	SAPHIR 3	SAPHIR 4	SAPHIR 5	SAPHIR 6	SAPHIR 7	SAPHIR 8	SAPHIR 9
	1502-1481.1	Wind bracing, side wall	1481 mm	4	4	4	4	4	4	4	4
	1502-1546.1	Wind bracing, roof	1546 mm	4	4	4	4	4	4	4	4
	690509	M6x12 mm screw		16	16	16	16	16	16	16	16
	690547	M6 nut		16	16	16	16	16	16	16	16

NOTE:

With the SAPHIR 2 greenhouse, a wind bracing from the roof crosses the surface in which the window is inserted. With the SAPHIR 2, the wind bracing on the roof does not have to be inserted during assembly if this wind bracing gets in the way.

However, we would like to urgently point out that all four wind bracings must be installed on all larger models so that the roof loads can be appropriately absorbed.

If you do not want the skylight to be crossed by a wind bracing on the inside, we recommend that with the larger models (from SAPHIR 3) you do not install any of the windows on the outer roof panels!

Step 7 – Assembling the wind bracings on the side walls and roof

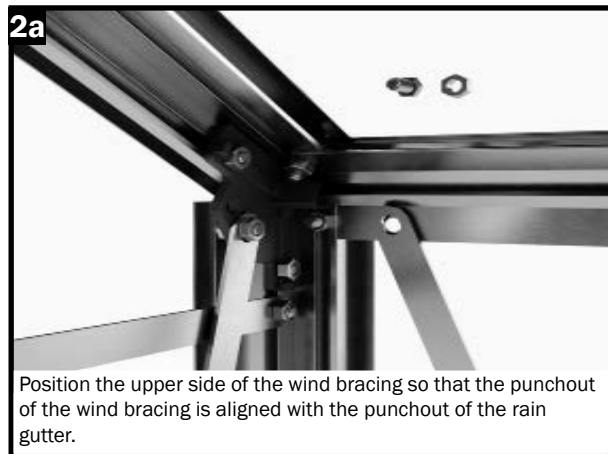

Step 7 - Assembling the wind bracings on the side walls and roof

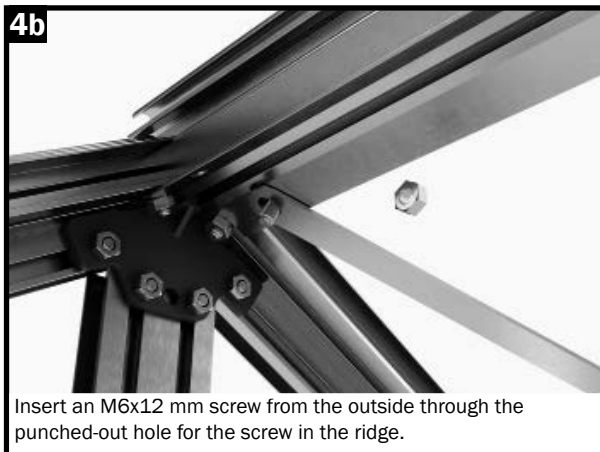

Perform the individual assembly steps for all other wind bracings of the side wall and the roof.

Step 8 – Glazing the greenhouse



Inserting the twin-wall sheets

In the following steps, the twin-wall sheets of your greenhouse are inserted into the prepared aluminium frame.

BEFORE ASSEMBLY:

Note that the glazing sheets have an inside and outside. The outside is UV-resistant and is marked with the inscription "OUTSIDE".

Alternatively, a film may have been applied to the sheets – the side with the film is the outer side.



1. Side walls and roof



Take a side twin-wall sheet and insert it into the foremost section of the side wall.

It may be necessary to loosen the wind bracing on the inside again to align the greenhouse exactly perpendicularly.

Step 8 – Glazing the greenhouse

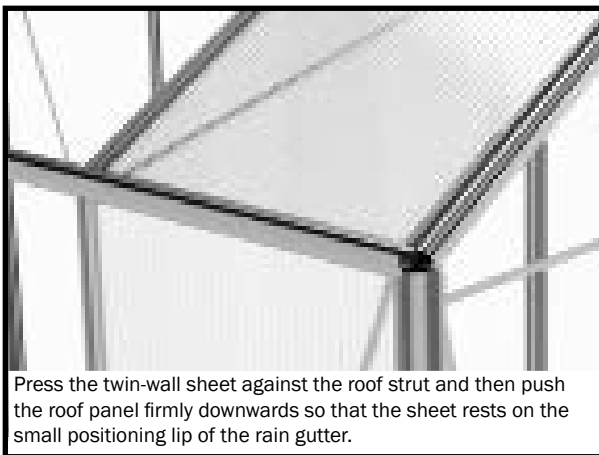
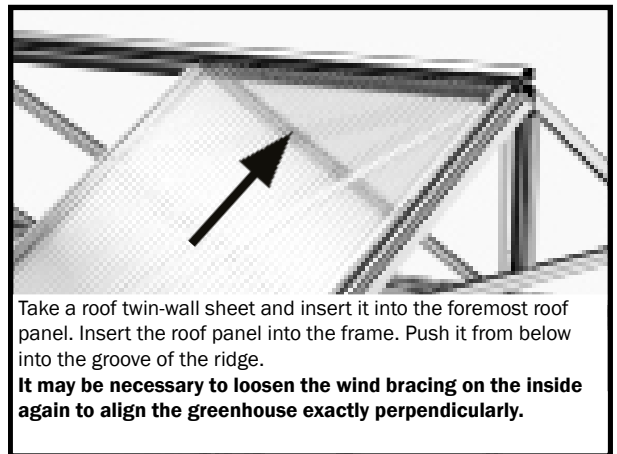
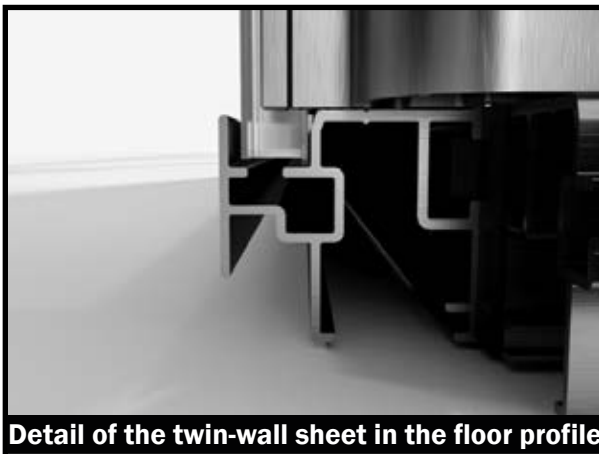
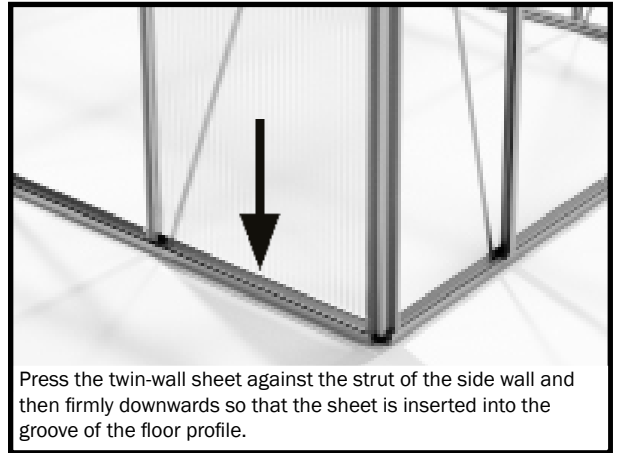
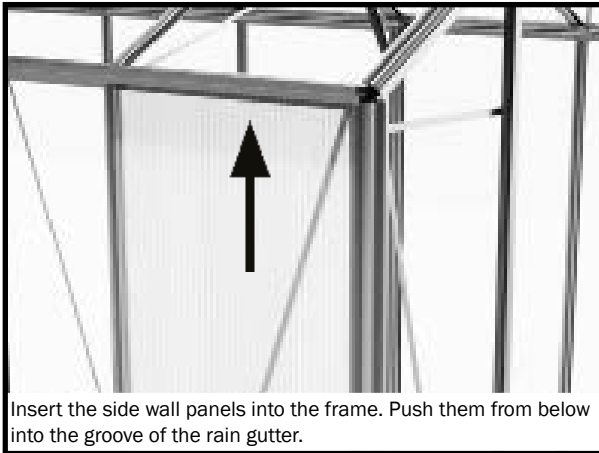

Finish glazing the side walls and the roof in the same way.

Note on twin-wall roof sheets:

When glazing the roof, you need to decide in advance where the skylights will be situated. For these panels, you will only glaze the roof halfway to the ridge.

We recommend installing the window openings on the side facing away from the prevailing wind, if possible.

Note that two skylights cannot be positioned directly next to each other!

NOTE:

Attaching the glazing strips to the greenhouse is explained in the following steps.

The twin-wall sheets are secured to the greenhouse frame with the aluminium terminal strips.

We recommend attaching the glazing strips to the greenhouse parallel to inserting the twin-wall sheets, so that the sheets are fixed directly to the greenhouse and can no longer fall off, e.g., due to a gust of wind.

Do not forget to screw the wind bracings back on tightly after completing the glazing, if necessary!

Step 8 – Glazing the greenhouse

Attaching the glazing strips:

The twin-wall sheets are secured to the greenhouse frame with the aluminium terminal strips.

The side and roof corner profiles as well as the coupling profiles have asymmetrical terminal strips, the roof and side wall struts have symmetrical terminal strips. The terminal strips and profiles each have the same length!

The terminal strips are screwed to the respective struts using 3.9 × 13 mm drilling screws. The necessary holes have already been pre-drilled into the strips.

NOTE!

If you place your greenhouse in a particularly wind-exposed area, we recommend installing additional drilling screws between the existing screw connections. To do this, screw the terminal strips to the greenhouse, drill the additional holes (3 mm drill bits) into the terminal strips and screw the terminal strips additionally with 3.9x13 mm drilling screws.

(A corresponding number of 3.9x13 mm screws is included in the assembly kit.)

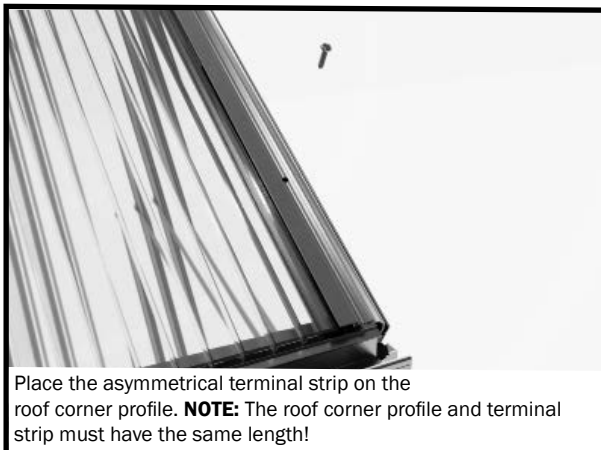
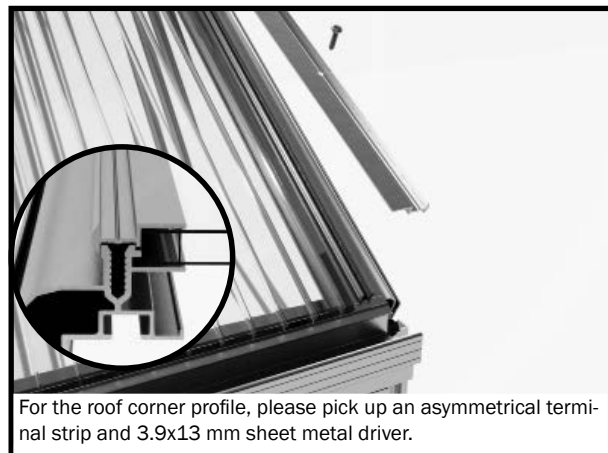
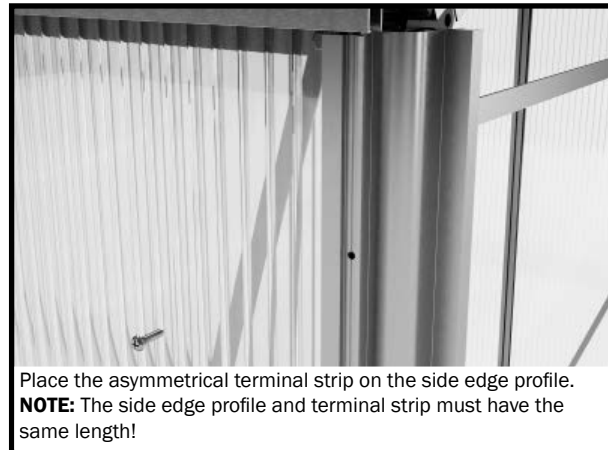
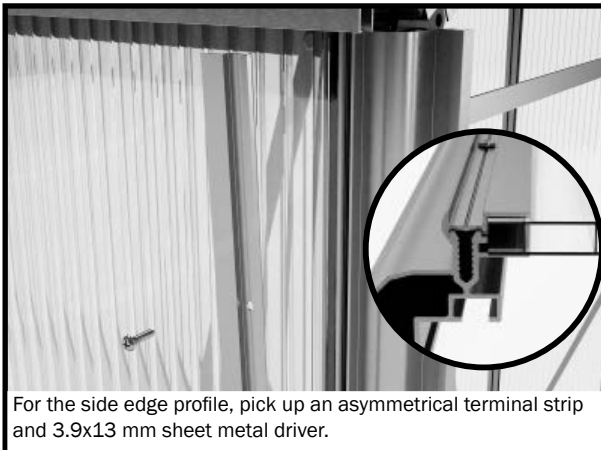

Step 8 – Glazing the greenhouse

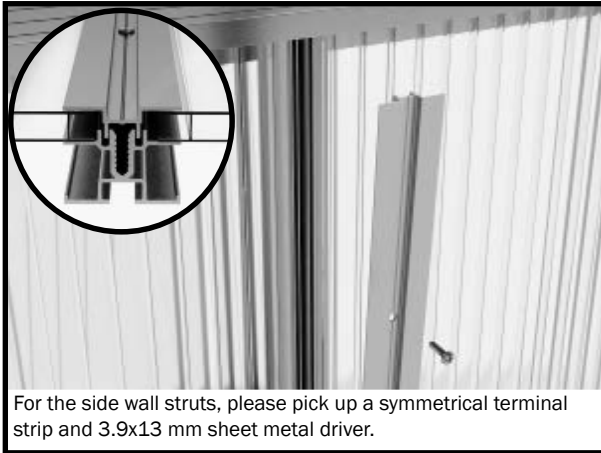

For the side wall struts, please pick up a symmetrical terminal strip and 3.9x13 mm sheet metal driver.

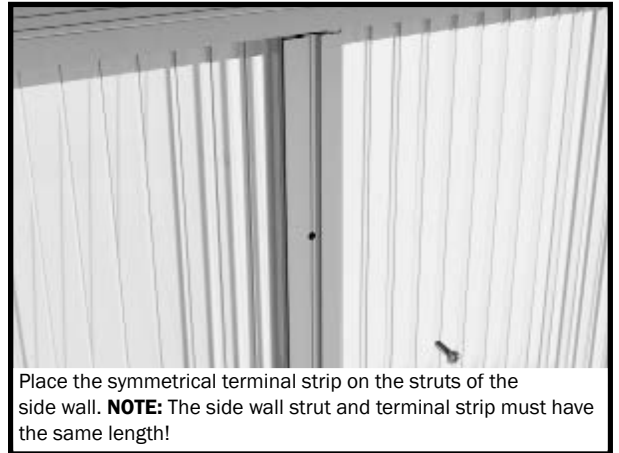

Place the symmetrical terminal strip on the struts of the side wall. **NOTE:** The side wall strut and terminal strip must have the same length!



Screw the terminal strip to the strut of the side wall

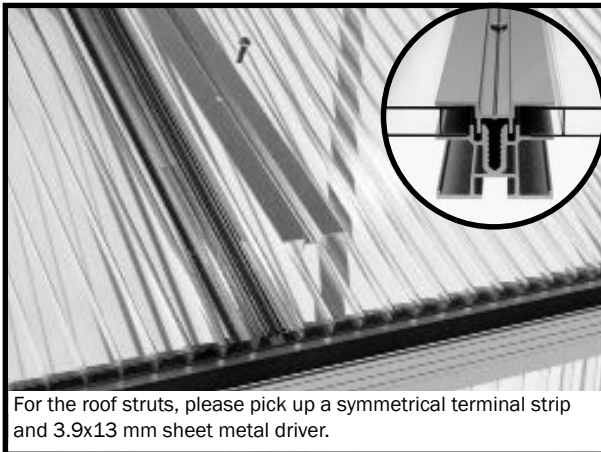

For the roof struts, please pick up a symmetrical terminal strip and 3.9x13 mm sheet metal driver.

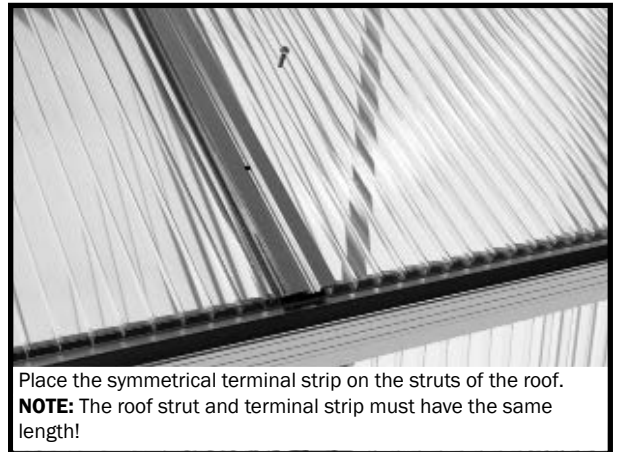

Place the symmetrical terminal strip on the struts of the roof. **NOTE:** The roof strut and terminal strip must have the same length!



Screw the terminal strip to the roof strut.



Step 8 – Glazing the greenhouse

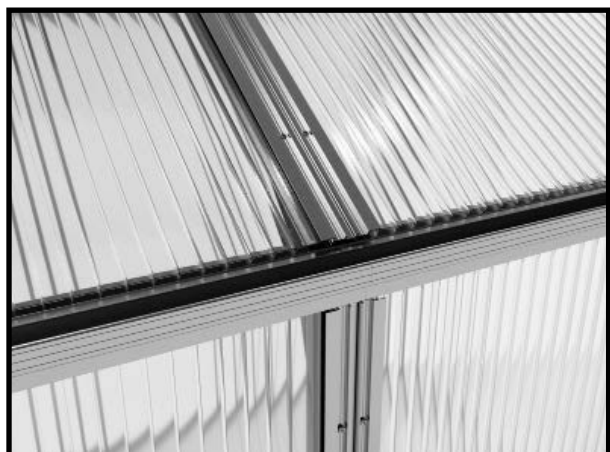
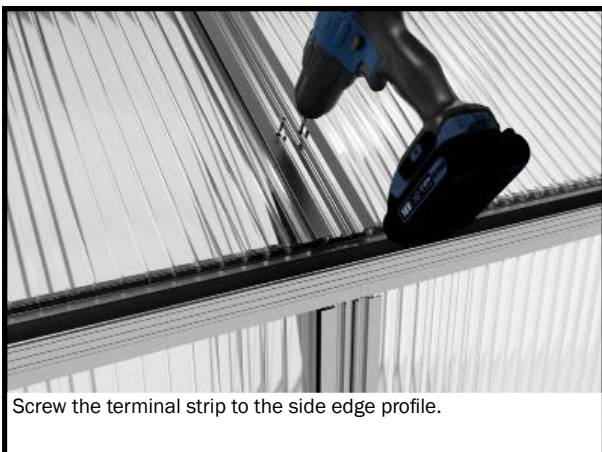
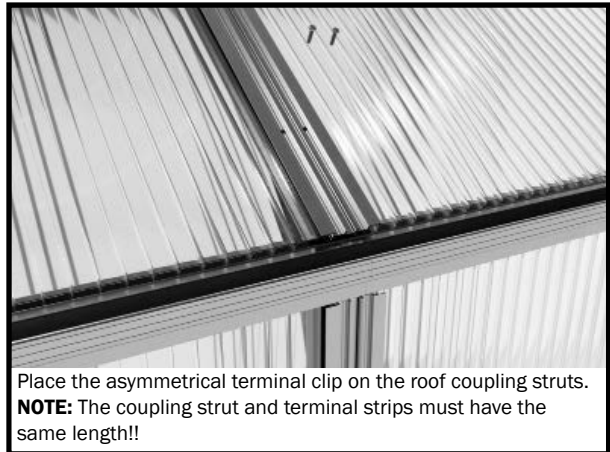
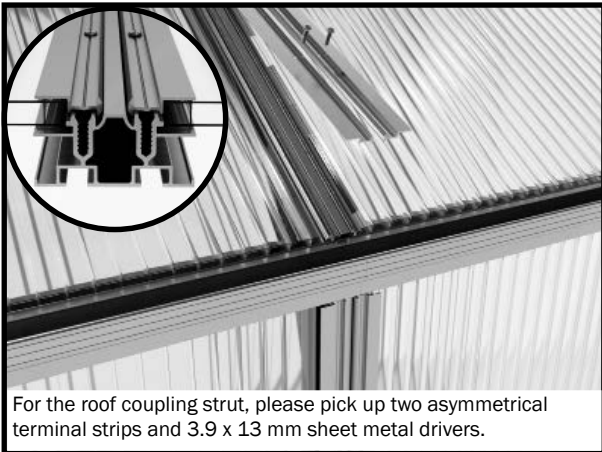
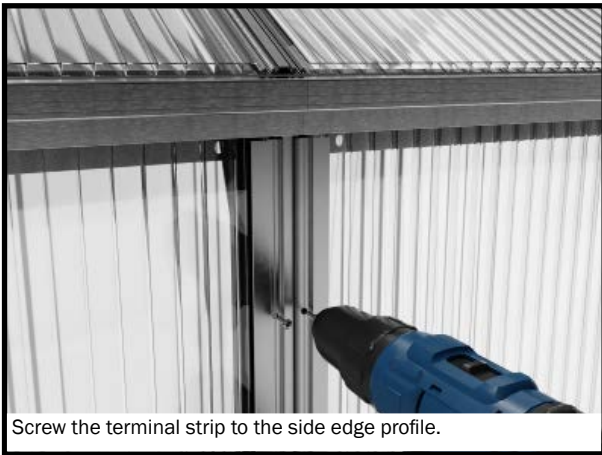

Step 8 – Glazing the greenhouse

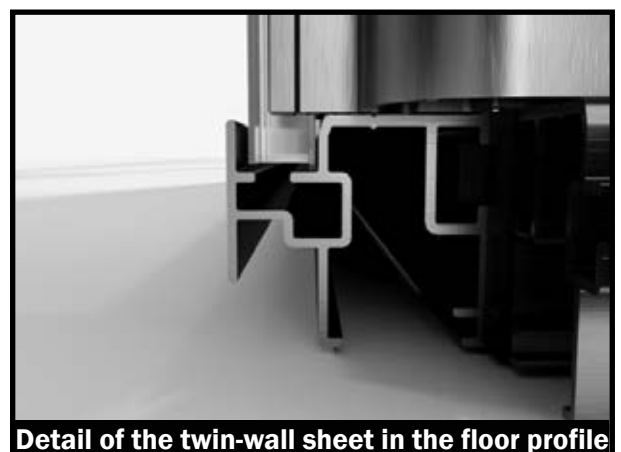
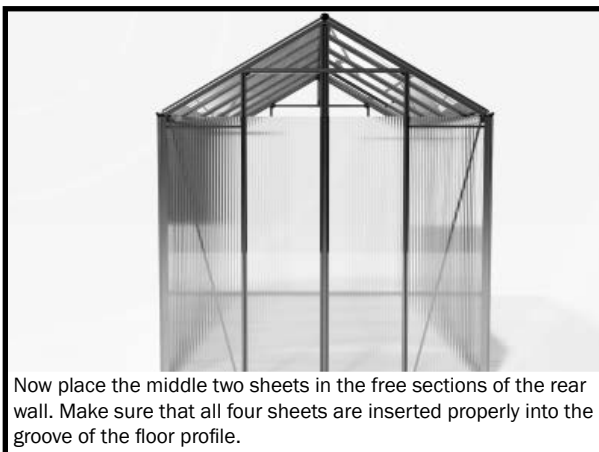
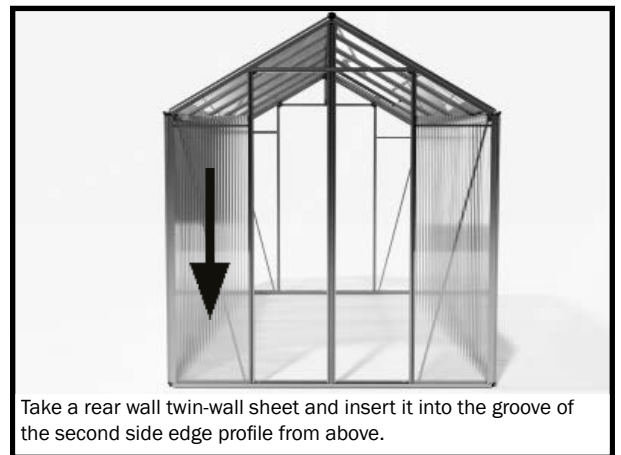
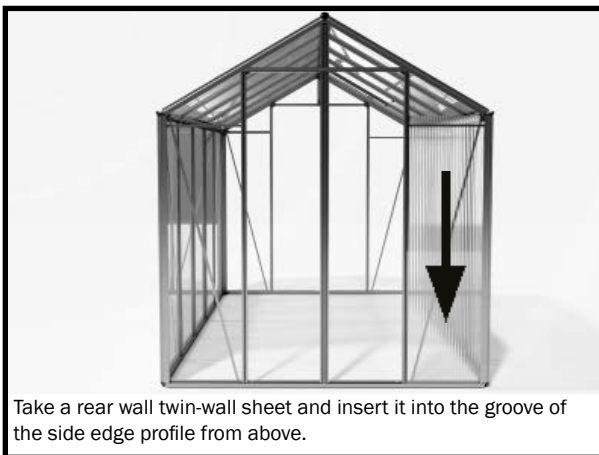
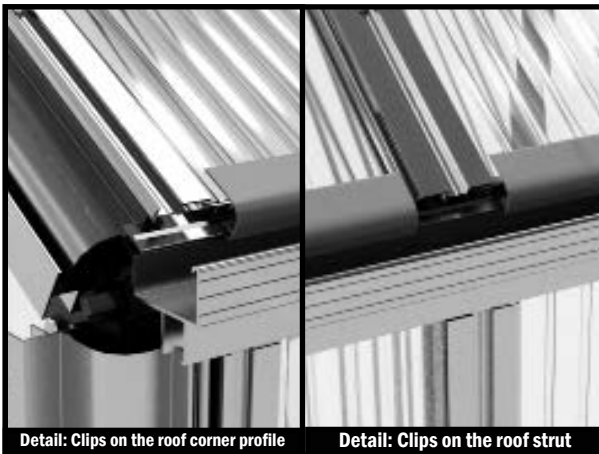
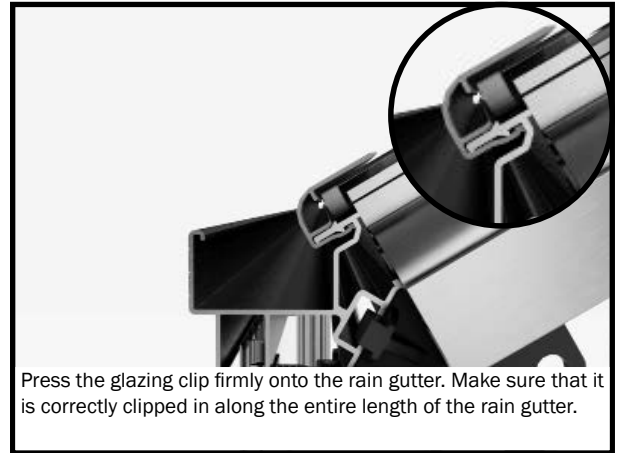

Step 8 – Glazing the greenhouse



Pick up four H-profiles.



Fit one H-profile on each of the four rear wall twin-wall sheets.
See also the detail above for fitting the H-profiles!

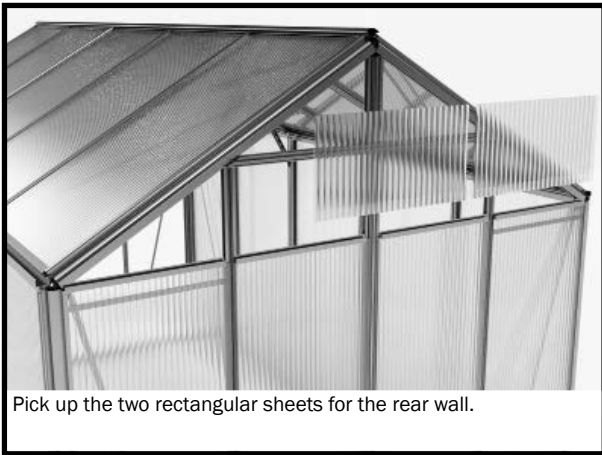

Pick up the two rectangular sheets for the rear wall.

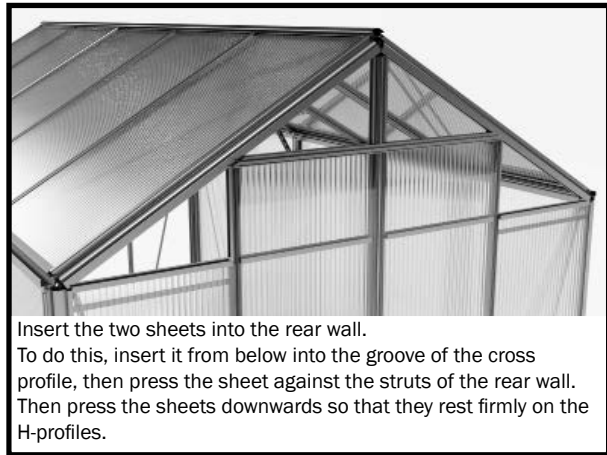

Insert the two sheets into the rear wall.
To do this, insert it from below into the groove of the cross profile, then press the sheet against the struts of the rear wall. Then press the sheets downwards so that they rest firmly on the H-profiles.

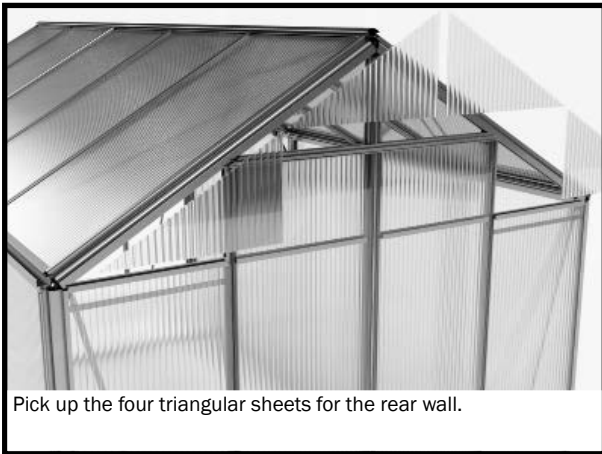

Pick up the four triangular sheets for the rear wall.

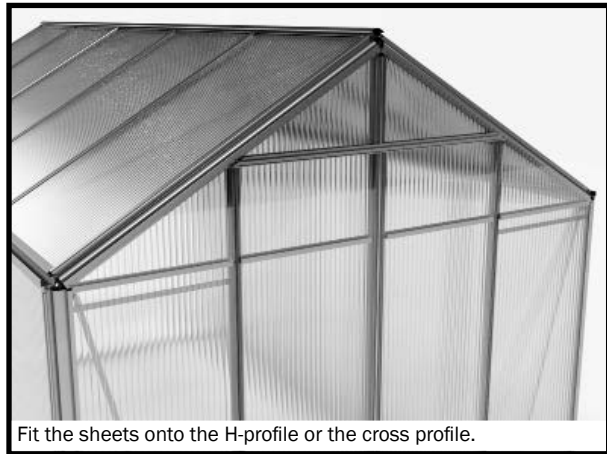

Fit the sheets onto the H-profile or the cross profile.



Take two plastic clips and cut them to the length of the roof corner profile.

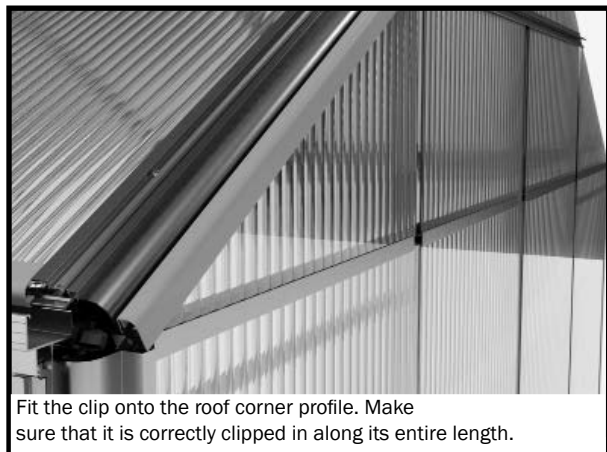

Fit the clip onto the roof corner profile. Make sure that it is correctly clipped in along its entire length.

Step 8 – Glazing the greenhouse

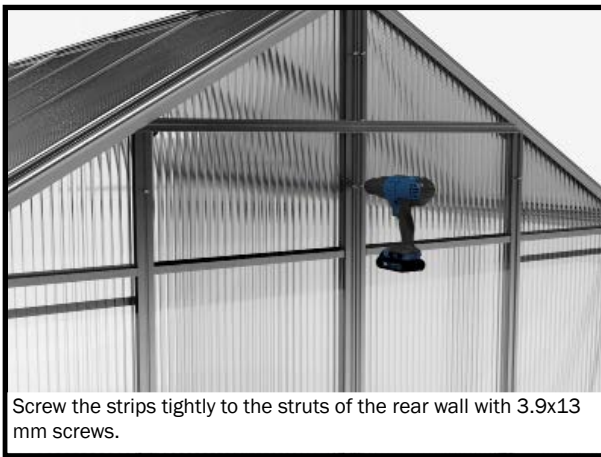
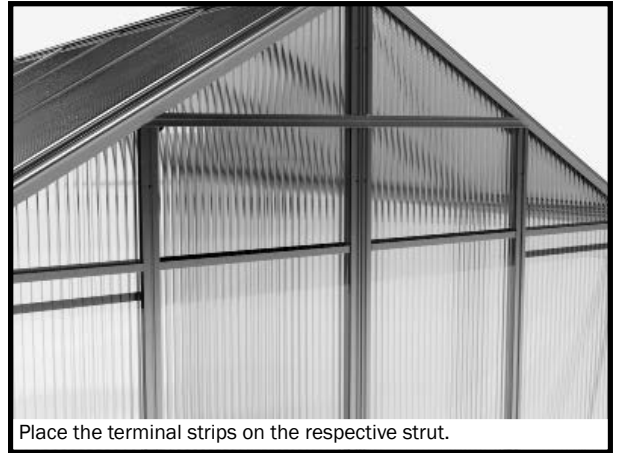
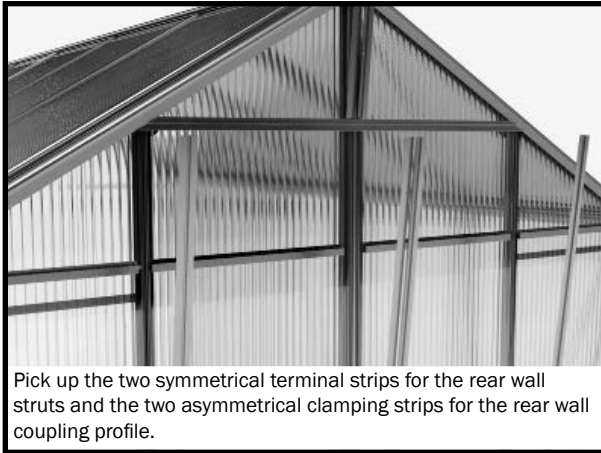

Step 8 – Glazing the greenhouse

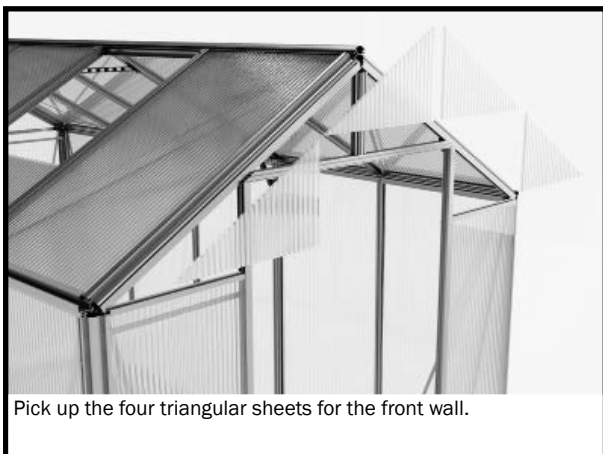
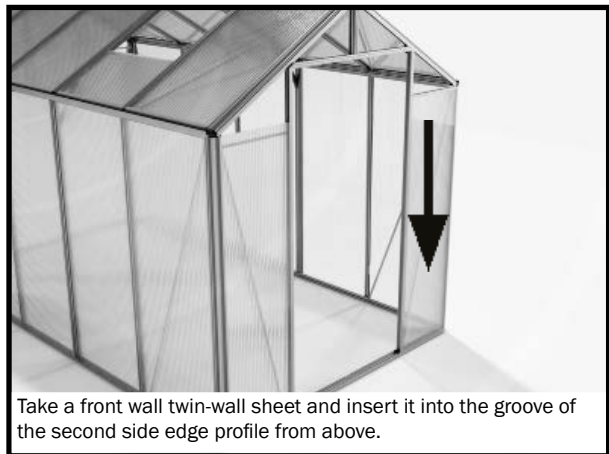
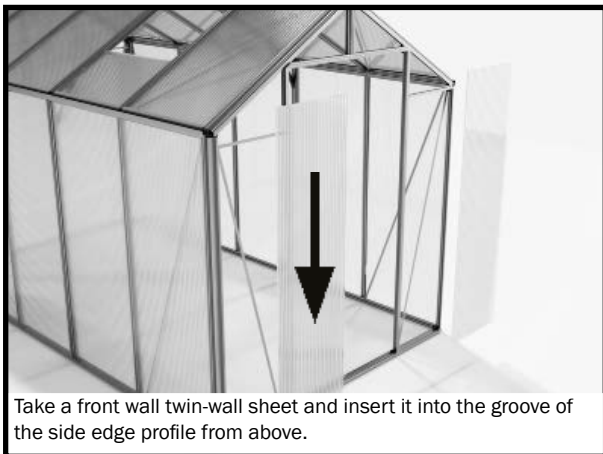

Step 8 – Glazing the greenhouse



Step 9 – Assembling the window

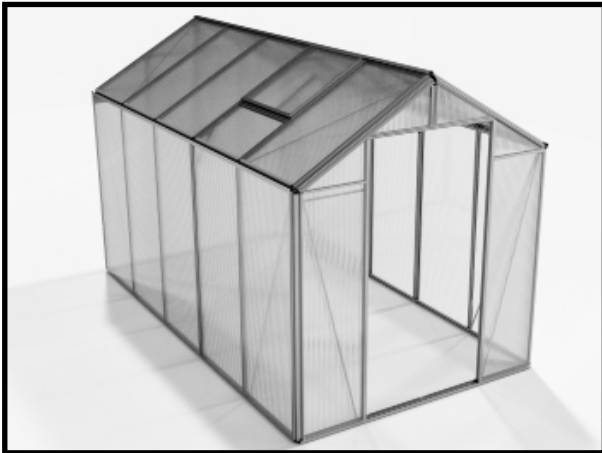

Assembly – WINDOW STOP

In the following phase of assembly, the window stop is mounted at each of the roof panels where a window is to be fixed.

Note:

An M6/12 mm rhombus screw (no. 690622) is used for assembling each window stop profile on each roof strut!!

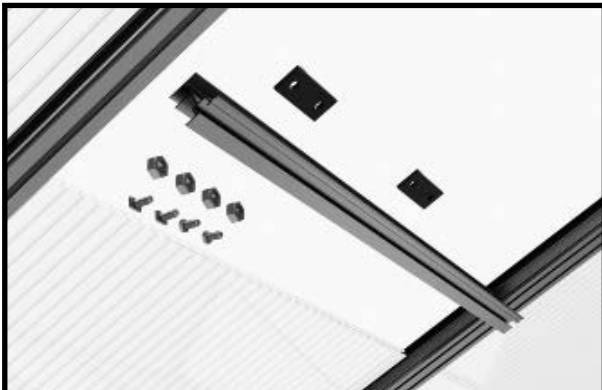

Take two straight connecting joints, two M6x12 screws, two rhombus screws and four nuts.

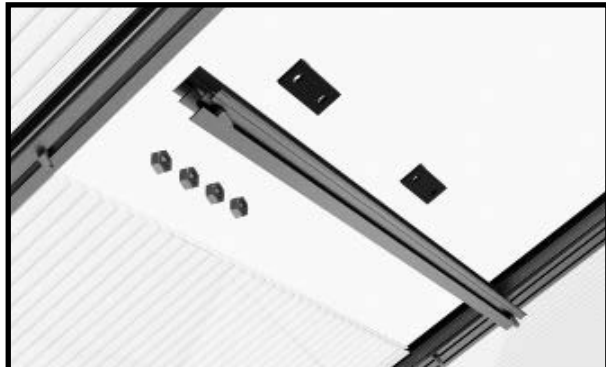

Insert an M6x12 mm screw into the screw channel on each side of the stop profile. Insert one rhombus screw each into the screw channel of the roof strut.

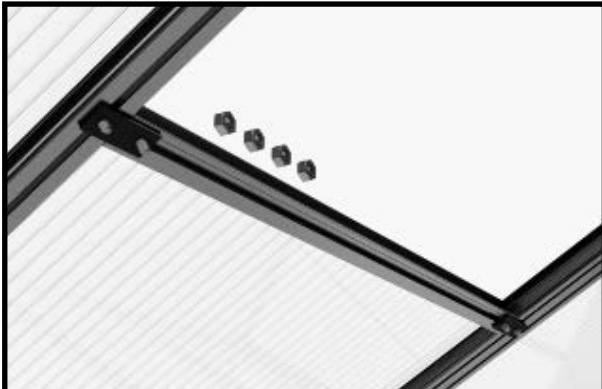

Place the window stop profile and push it down so that it pushes firmly against the twin-wall sheet.



Screw the plastic connector tightly using M6 nuts. Make sure that the rhombus screw becomes wedged in the screw channel of the roof strut!

Assembling and installing the window

The window is assembled in the following phase of assembly.

Note: The M6/12 mm screws shown in Figure 1a are only needed once, and are therefore only inserted into the screw channel on one side.

After assembly, the window is pushed into the ridge.

IMPORTANT:

Slide the window from the end of the ridge profile to the desired position.

Step 9 – Assembling the window

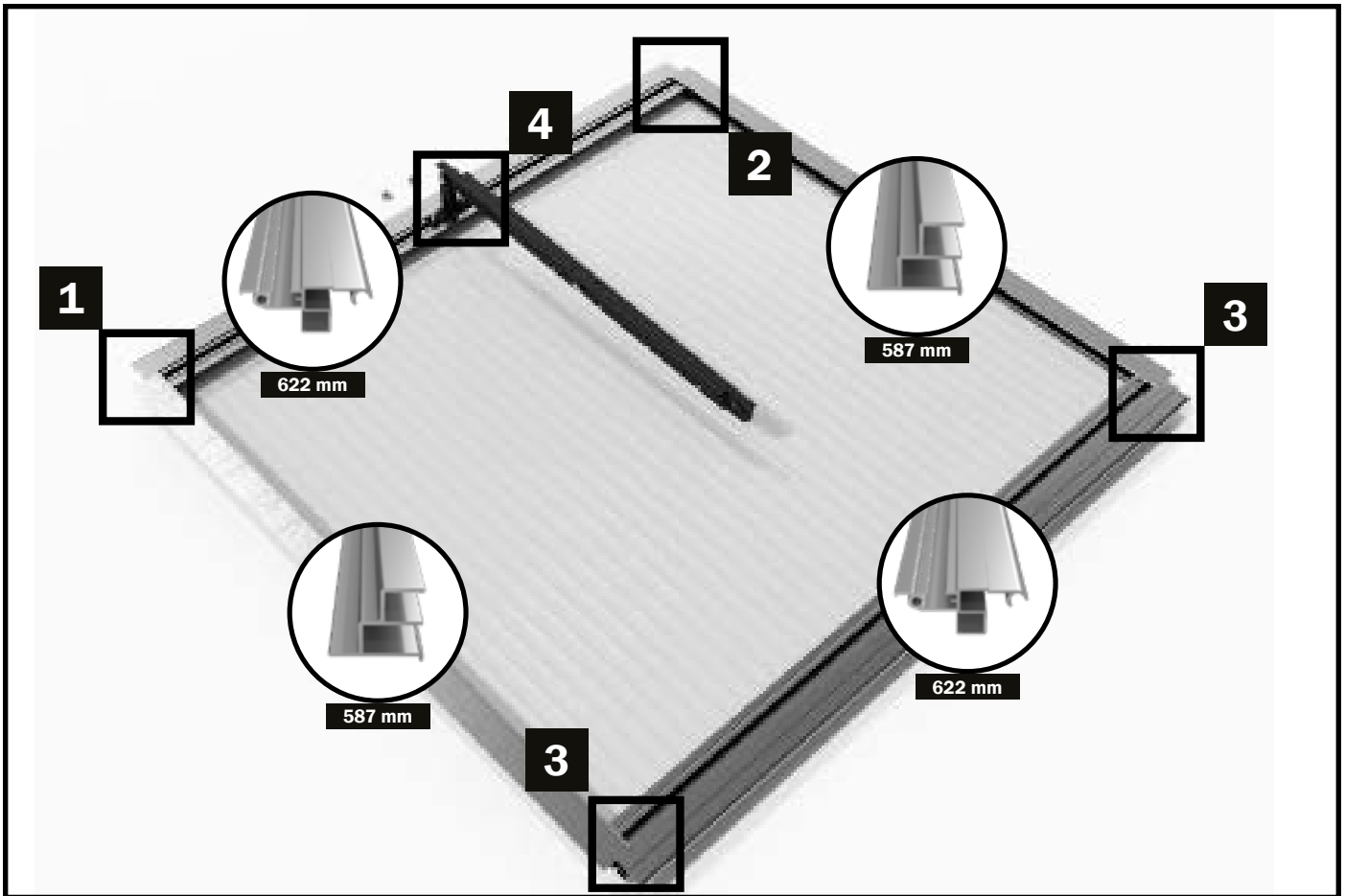

For this assembly step you will need:

SKETCH	PART. NO.	DESIGNATION	LENGTH	SAPHIR 2	SAPHIR 3	SAPHIR 4	SAPHIR 5	SAPHIR 6	SAPHIR 7	SAPHIR 8	SAPHIR 9
	03-0622-1	Window hinge profile	622 mm	2	2	4	4	6	6	8	8
	04-0587-1	Window profile, side	587 mm	2	2	4	4	6	6	8	8
	15-0594-1	Window stop	594 mm	1	1	2	2	3	3	4	4
	NG206	Connecting joint, straight		2	2	4	4	6	6	8	8
	665958	Hobby window stay		1	1	2	2	3	3	4	4
	664753	Tapping screws, 4.2x22 mm		4	4	8	8	12	12	16	16
	690622	M6x12 mm rhombus screw		2	2	4	4	6	6	8	8
	690509	M6x12 mm screw		4	4	8	8	12	12	16	16
	690547	M6 nut		6	6	12	12	18	18	24	24
		Twin-wall sheet window, 610x603 mm		1	1	2	2	3	3	4	4

Step 9 – Assembling the window

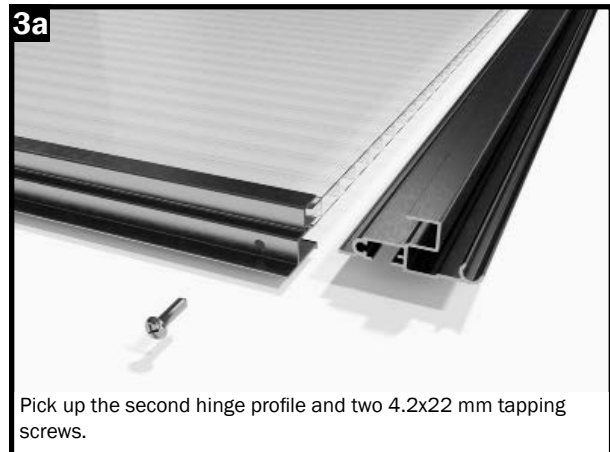
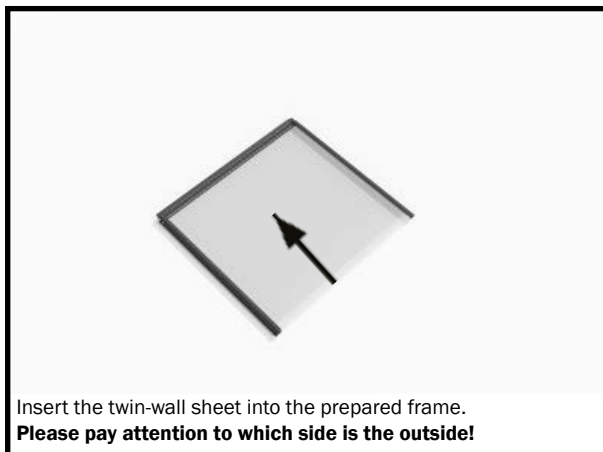
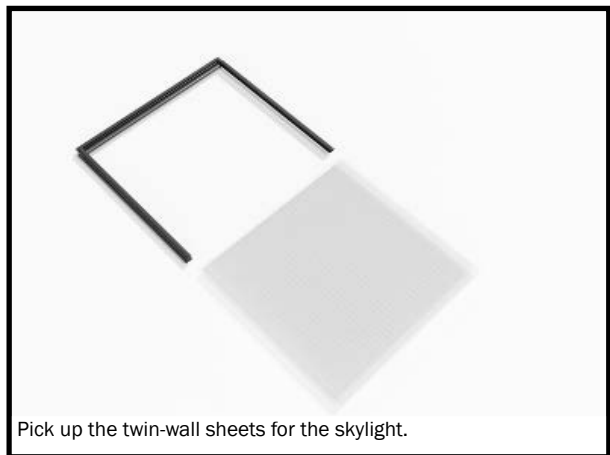
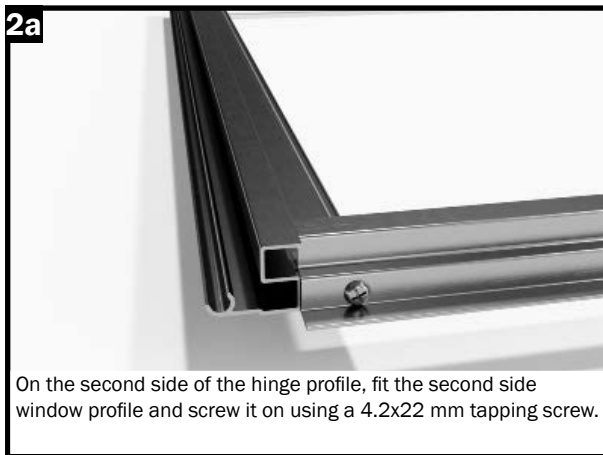
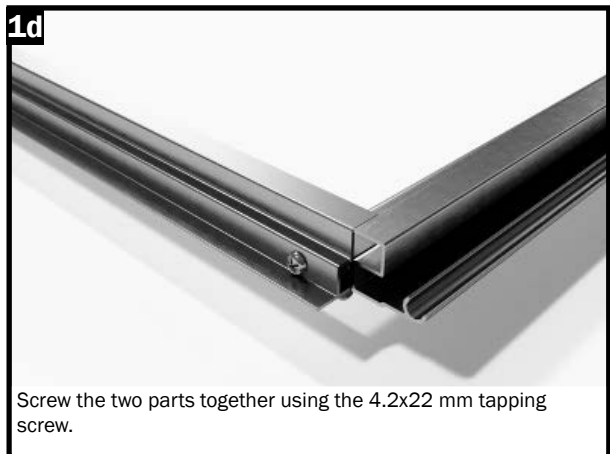
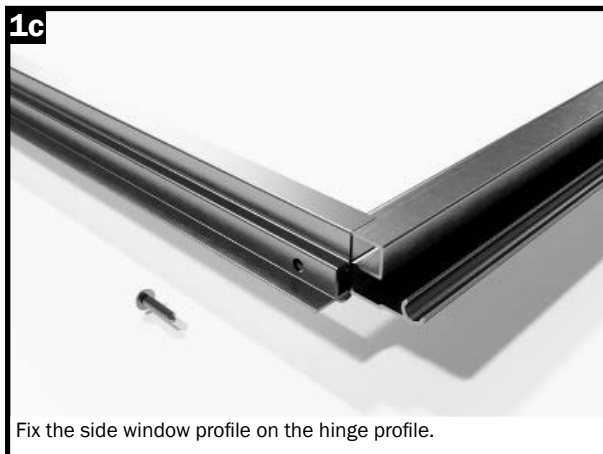
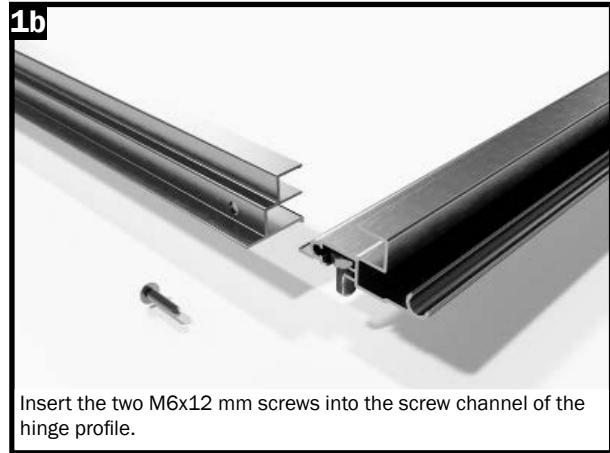
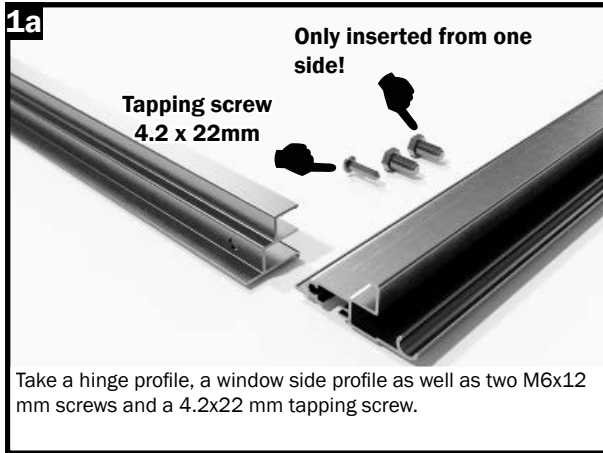

Step 9 – Assembling the window



Mounting the window stay:

Connect the two individual parts using one M6x12 mm screw and one M6 nut.

The two hinge profiles are screwed together with one M6x16 mm screw and one M6 self-locking nut.

The M6 self-locking nut must be tightened so that the profiles can only be moved with a certain amount of force.



Overview of the window stay assembly

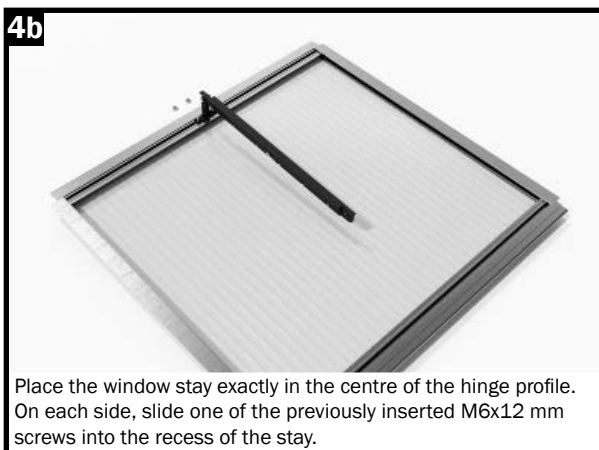
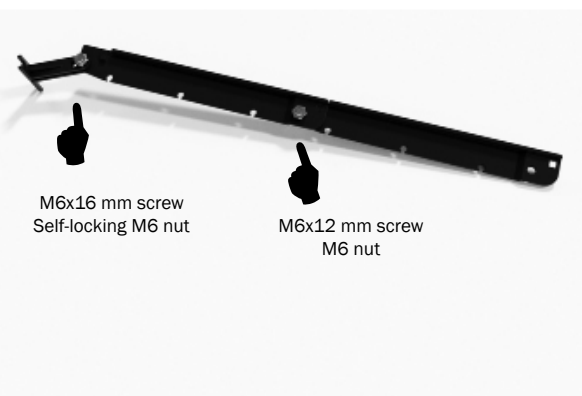

Step 9 – Assembling the window

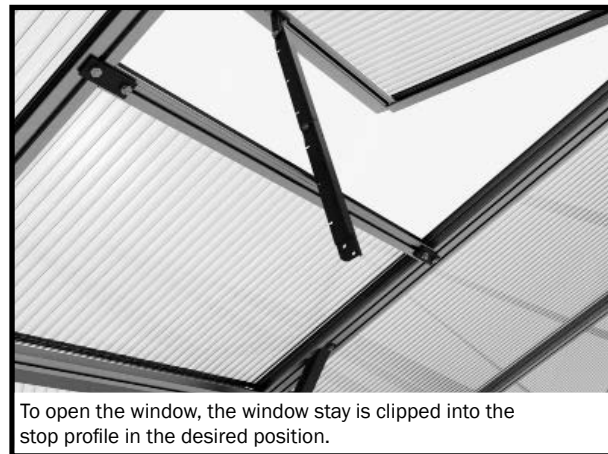
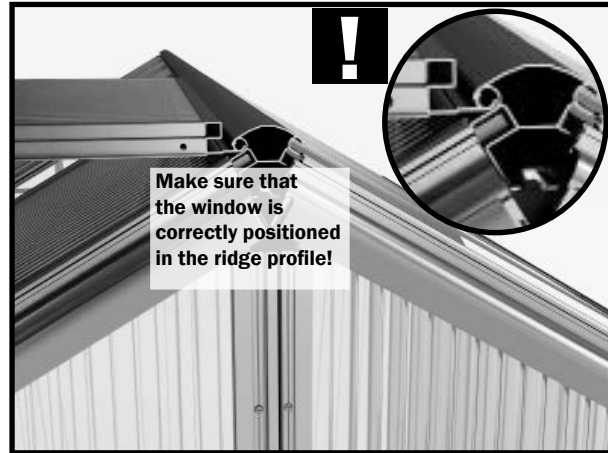

Automatic window opener

The installation of an automatic skylight opener is recommended as a useful accessory. This ensures carefree and optimal ventilation of your greenhouse. It protects your valuable plants from heat accumulation inside the greenhouse. The temperature is adjustable and it works without electricity. The window stay included in the delivery contents is simply exchanged for the automatic opener.

IMPORTANT: In winter, the automatic window opener needs to be protected from frost. Replacing the automatic window opener with the manual window stay is recommended!

Step 10 – Assembling the door casements

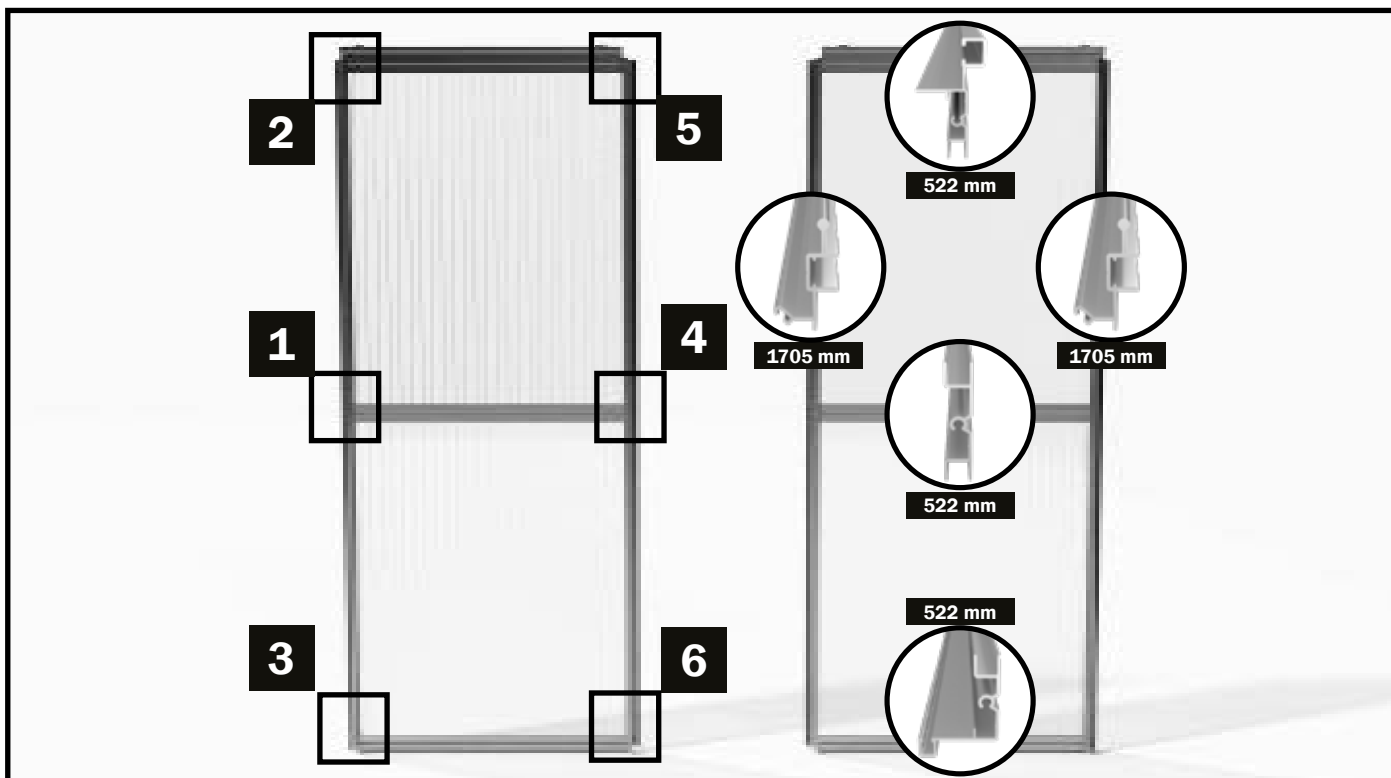

For this assembly step you will need:

SKETCH	PART. NO.	DESIGNATION	LENGTH	SAPHIR	SAPHIR	SAPHIR	SAPHIR	SAPHIR	SAPHIR	SAPHIR	SAPHIR
				2	3	4	5	6	7	8	9
	20-1705.1	Door frame upright	1705 mm	4	4	4	4	4	4	4	4
	11-1298.1	Door rail	1298 mm	2	2	2	2	2	2	2	2
	17-0607.1	Door profile, top	607 mm	2	2	2	2	2	2	2	2
	16-0607.1	Door profile, middle	607 mm	2	2	2	2	2	2	2	2
	18-0607.1	Door profile, bottom	607 mm	2	2	2	2	2	2	2	2
	1502-0348.1	Door rail support	348 mm	2	2	2	2	2	2	2	2
	CT510 GAR3440	Hobby door seal	3440 mm	2	2	2	2	2	2	2	2
	664555	Axle pin		4	4	4	4	4	4	4	4
	NG209	Door roller		4	4	4	4	4	4	4	4
	NG201	Door rail protection		2	2	2	2	2	2	2	2
	NG201L NG201R	Drain pipe, left Drain pipe, right		1 1	1 1	1 1	1 1	1 1	1 1	1 1	1 1
	664753	Tapping screws, 4.2x22 mm		12	12	12	12	12	12	12	12
	690509	M6x12 mm screw		2	2	2	2	2	2	2	2
	690547	M6 nut		6	6	6	6	6	6	6	6
		Twin-wall sheet for door, 610x809 mm		4	4	4	4	4	4	4	4

Step 10 – Assembling the door casements

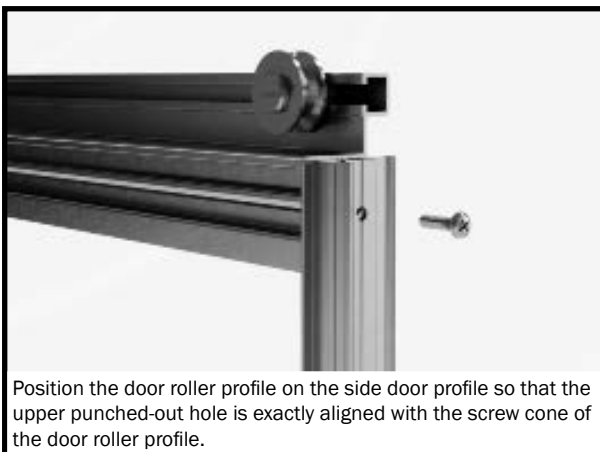
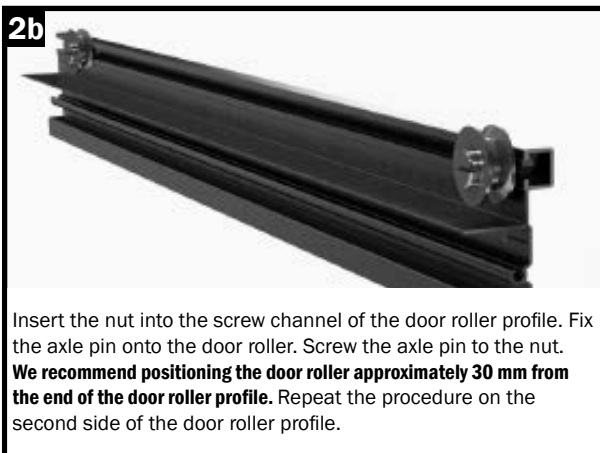
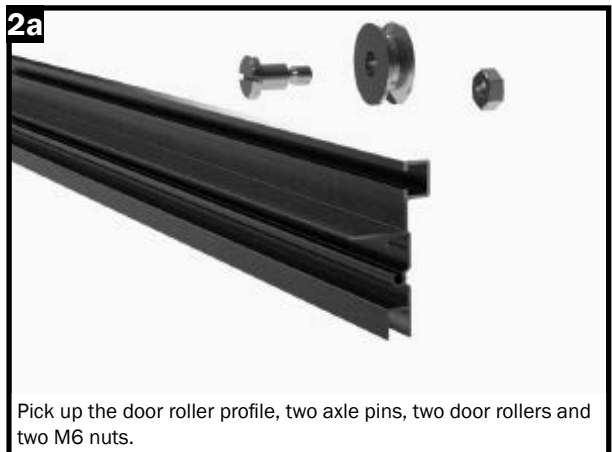
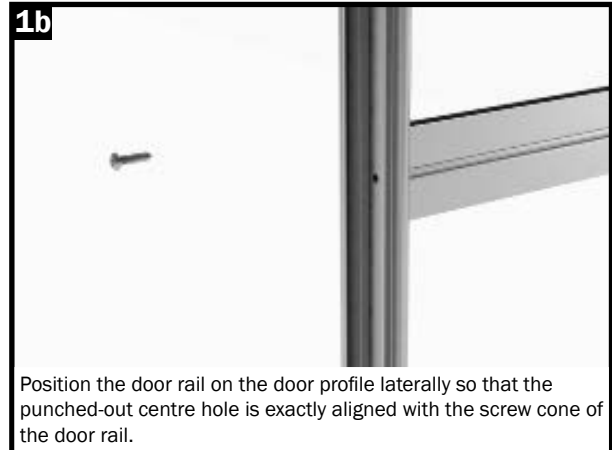
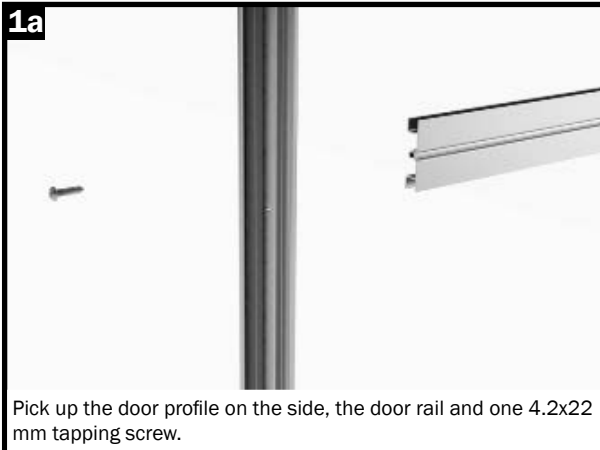

Step 10 – Assembling the door casements

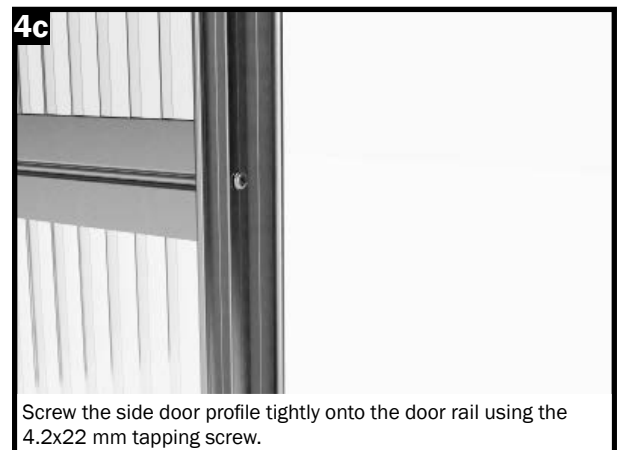
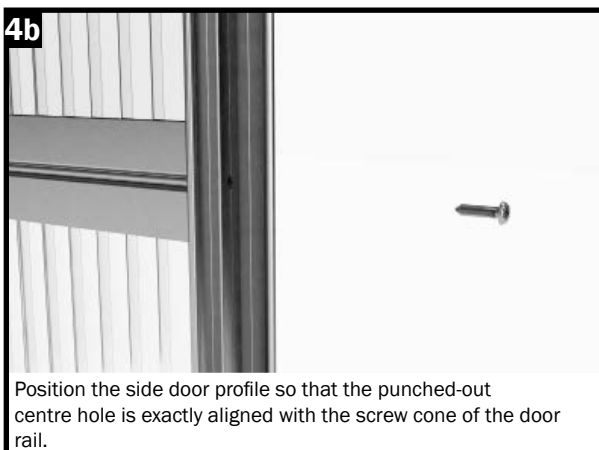
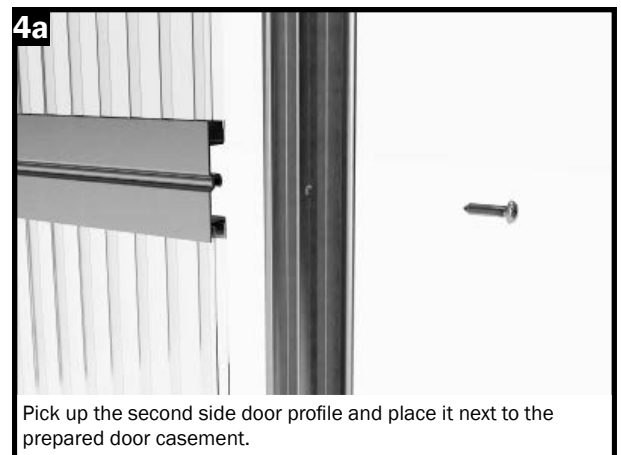
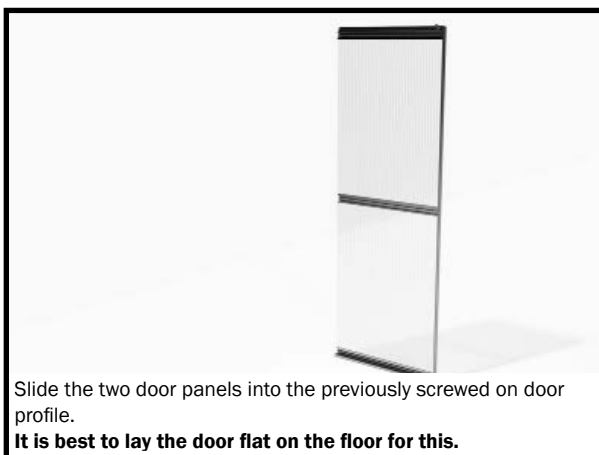
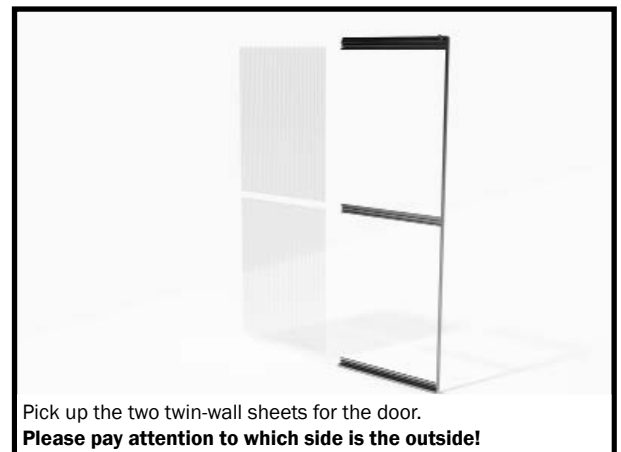
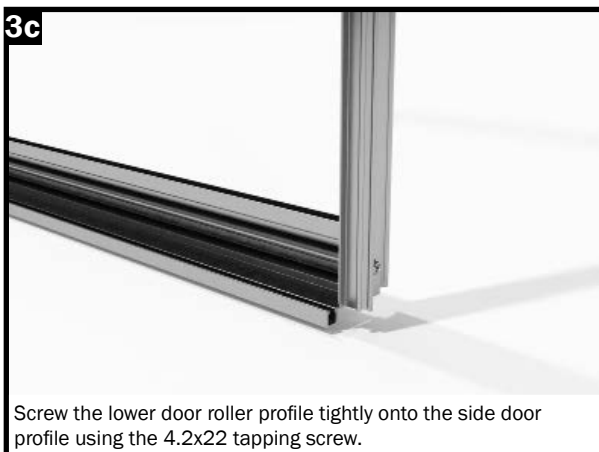
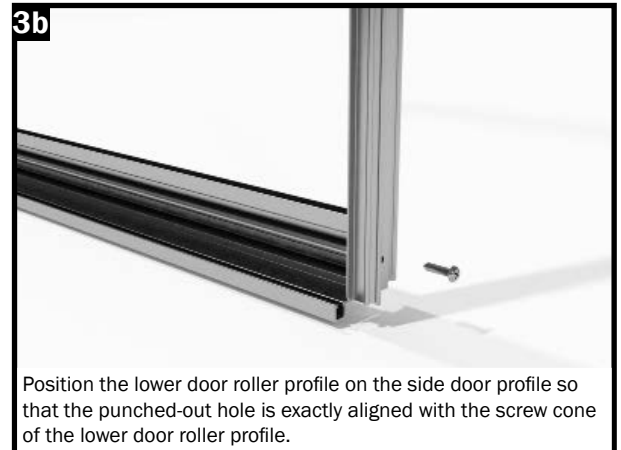
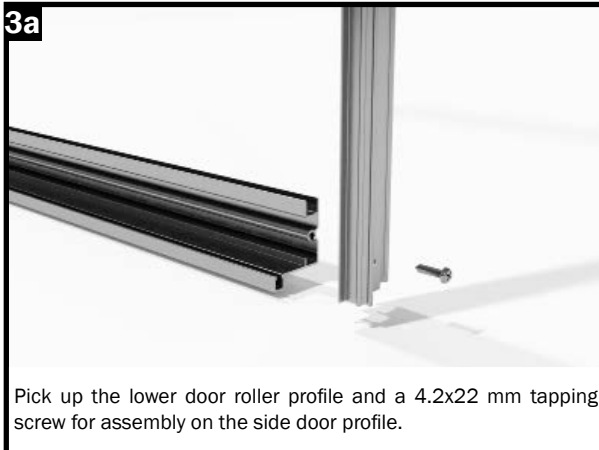

Step 10 – Assembling the door casements



Inserting the door seal

Note:

The door seal is inserted into the door frame profiles pointing outwards in such a way that it points in the direction of the greenhouse. This covers the gap between the door casement and the door frame profile.

At the point where the two door casements meet in the middle, the door seal is turned 90 degrees so that the door seal points in the direction of the second door casement.

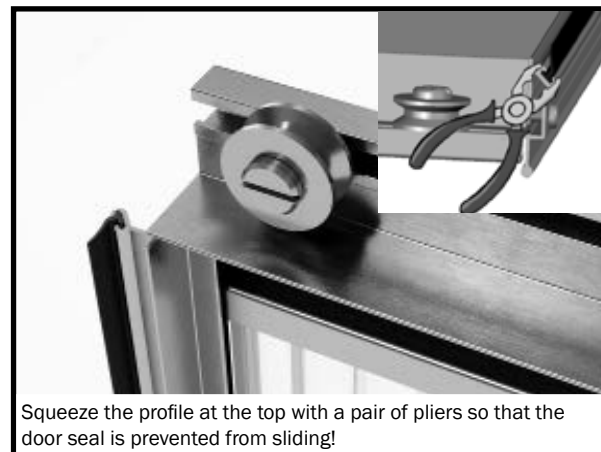
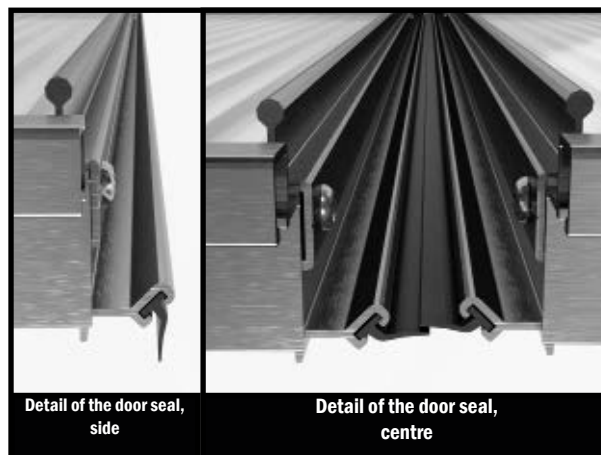

Step 11 – Inserting the door casements

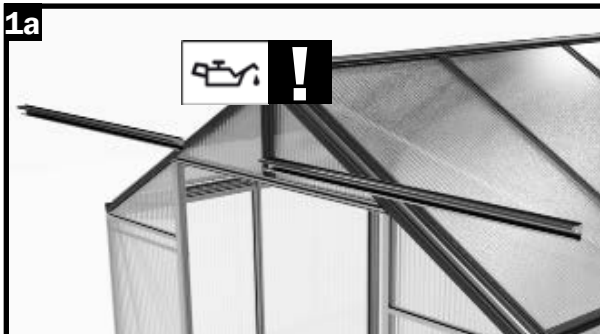
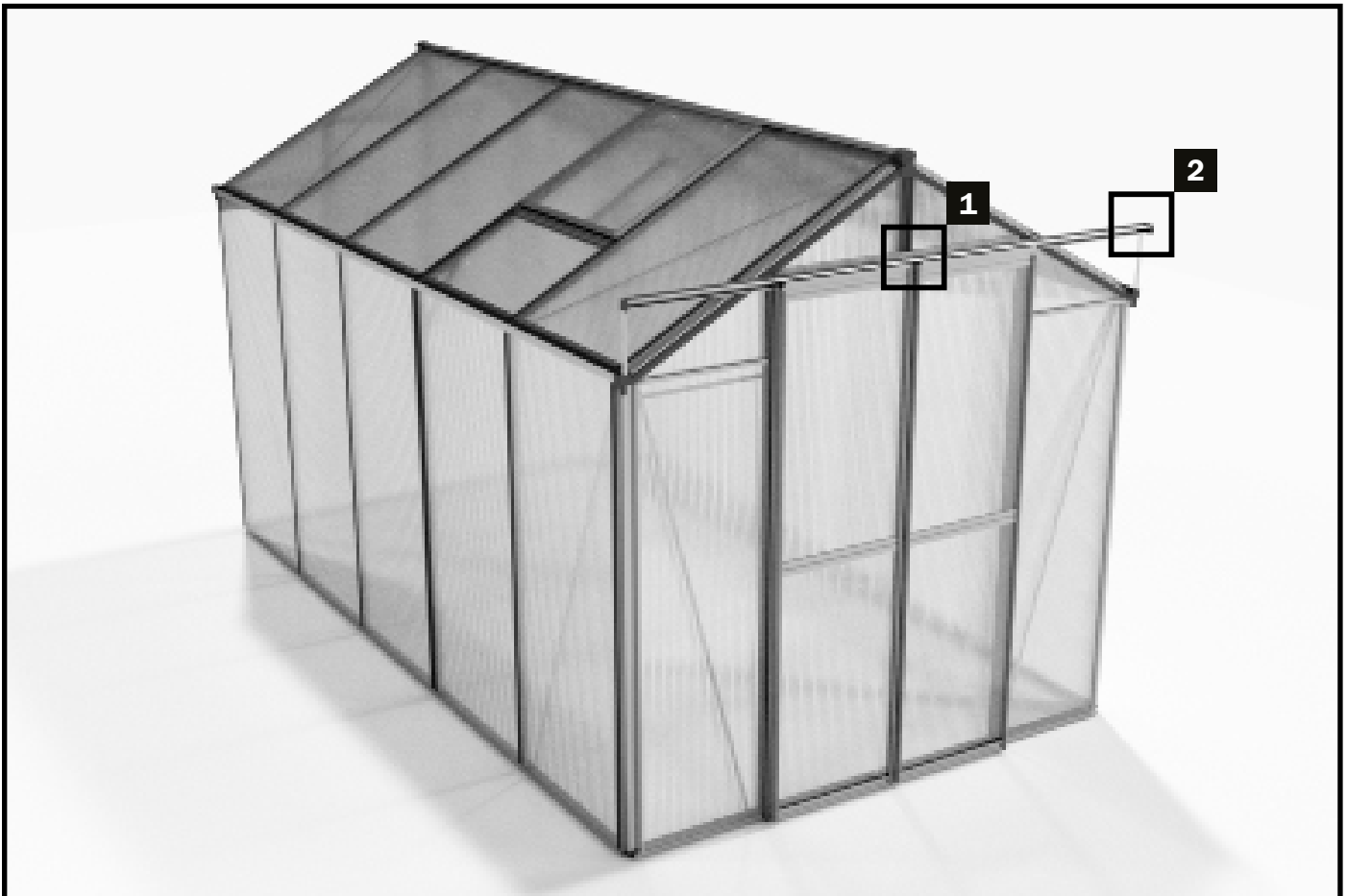

Pick up the two door rails.

ATTENTION: Before inserting them from the side into the cross strut, use some oil (not included in the delivery contents) to avoid jamming the profiles!

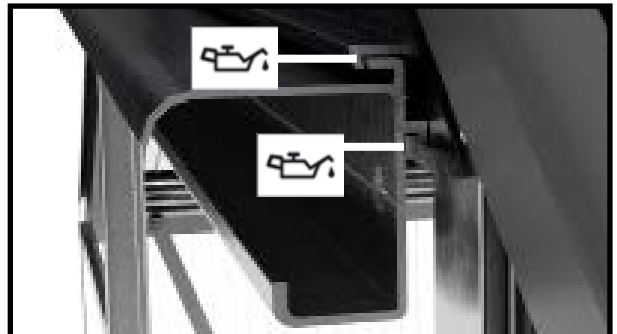

Insert the first door rail according to the cross-section shown into the cross profile.

Please use some oil at the marked points to make the insertion smooth!



Insert the door rail into the cross profile up to the middle of the door opening.



Now insert the second door rail into the cross strut. Align the parts so that the two door rails meet exactly in the middle.

Step 11 – Inserting the door casements

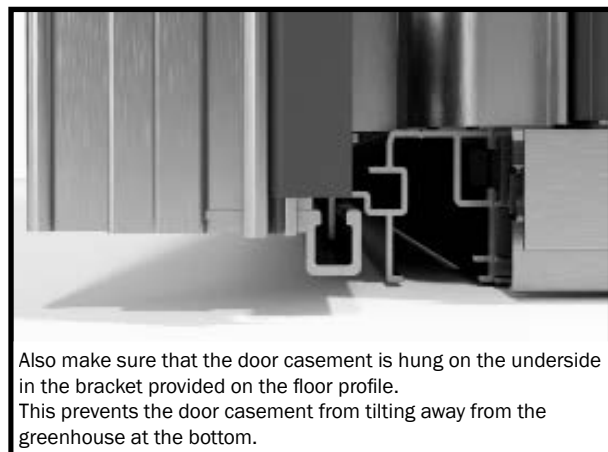
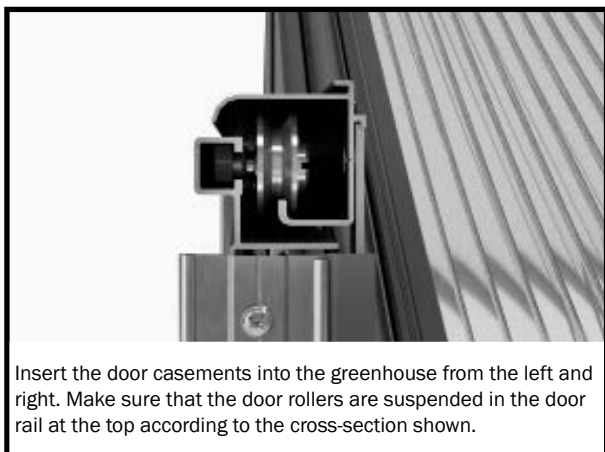
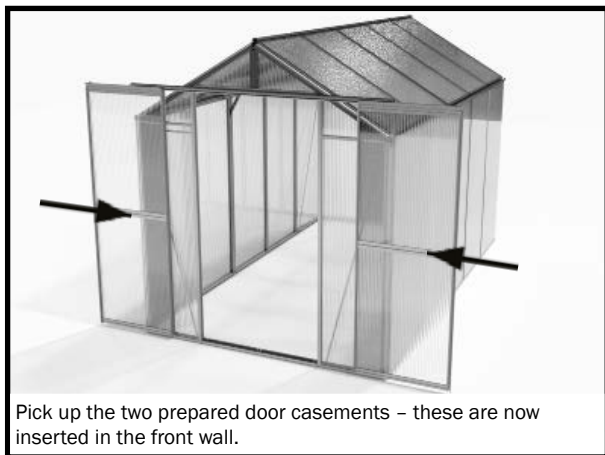

Step 11 – Inserting the door casements

2e



For each side of the door rail, use a door rail guard, an M6x12 screw and an M6 nut.

2f



Fit the door rail guard onto the door rail profile.

2g



Insert the M6x12 mm screw from behind through the hole in the door rail and door rail guard.

2h





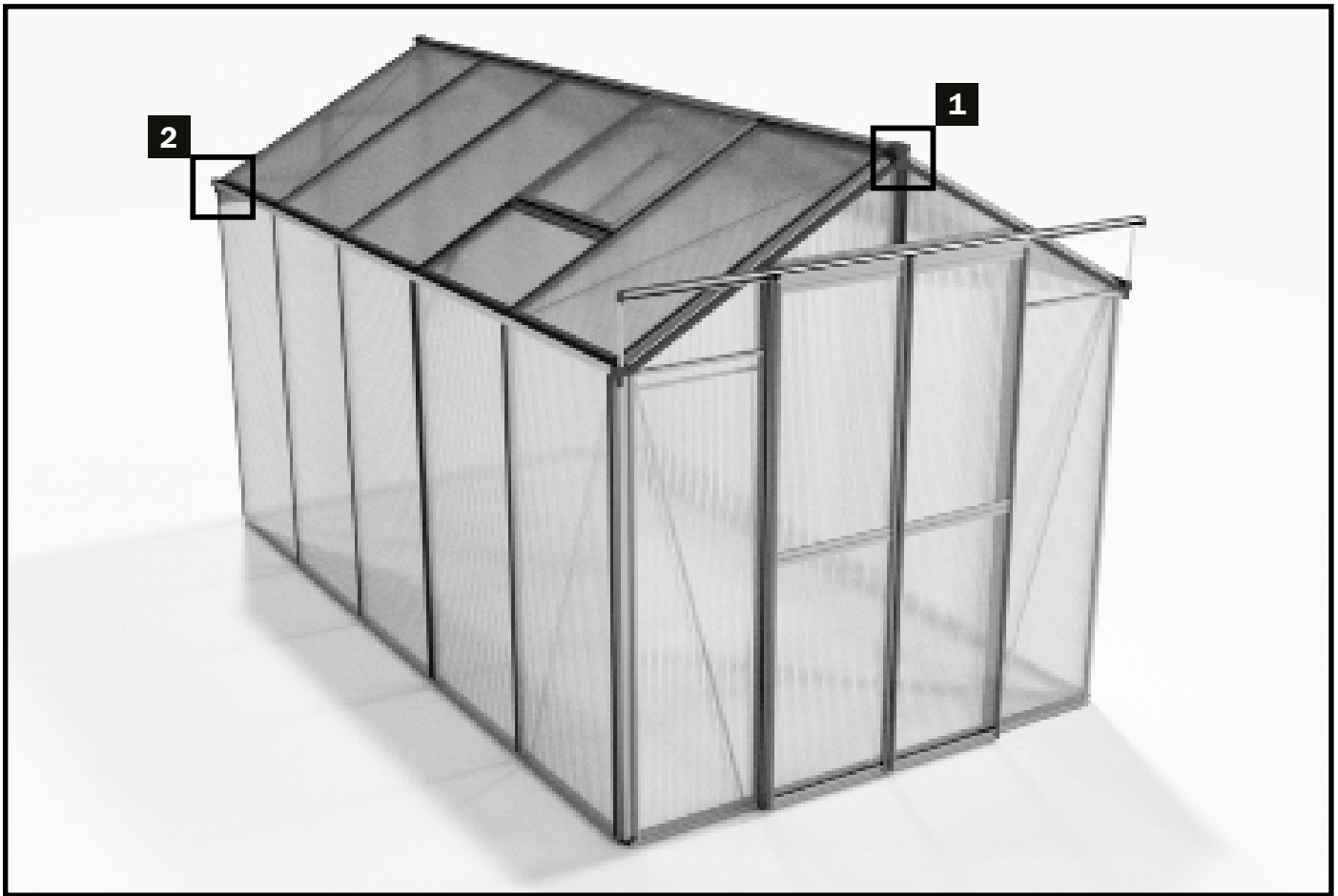

Screw the door rail guard, the door rail and the support tightly together with an M6 nut.

Step 12 – Final work



For this assembly step you will need:

SKETCH	PART. NO.	DESIGNATION	LENGTH	SAPHIR 2	SAPHIR 3	SAPHIR 4	SAPHIR 5	SAPHIR 6	SAPHIR 7	SAPHIR 8	SAPHIR 9
	NG204	Ridge covering		2	2	2	2	2	2	2	2
	NG202L	Drain pipe, left		1	1	1	1	1	1	1	1
	NG202R	Drain pipe, right		1	1	1	1	1	1	1	1
		Drilling screw, 3.9x13		4	4	4	4	4	4	4	4

Final work

Finally the ridge cap covers and the left and right rear wall drain pipes need to be fixed.

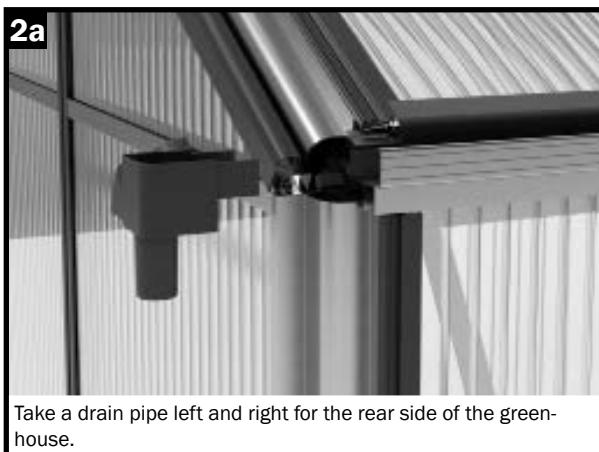
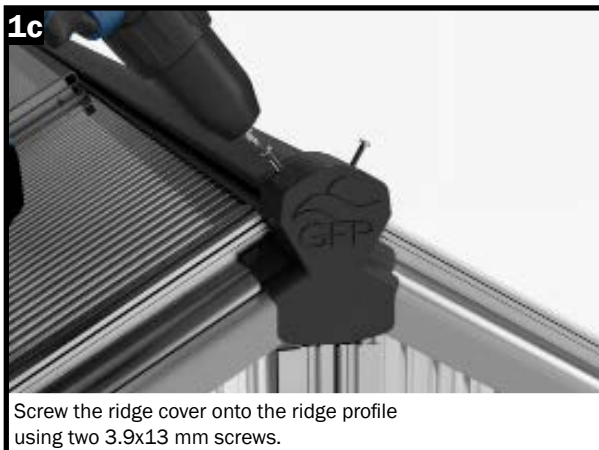
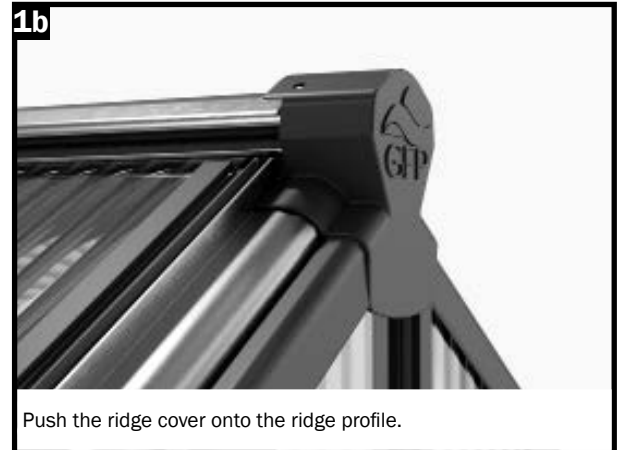
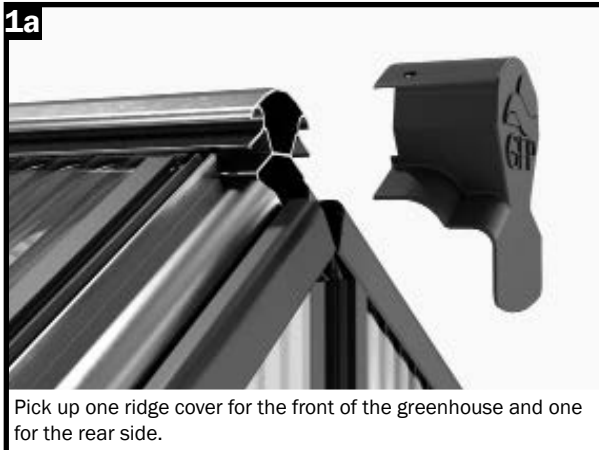

You're finished!
Congratulations!
We hope you enjoy your new
plant paradise!

Final note:

Please do not forget to check and retighten all screw connections after completing the assembly!

Please repeat this process again after about two weeks!