

ASSEMBLY INSTRUCTIONS

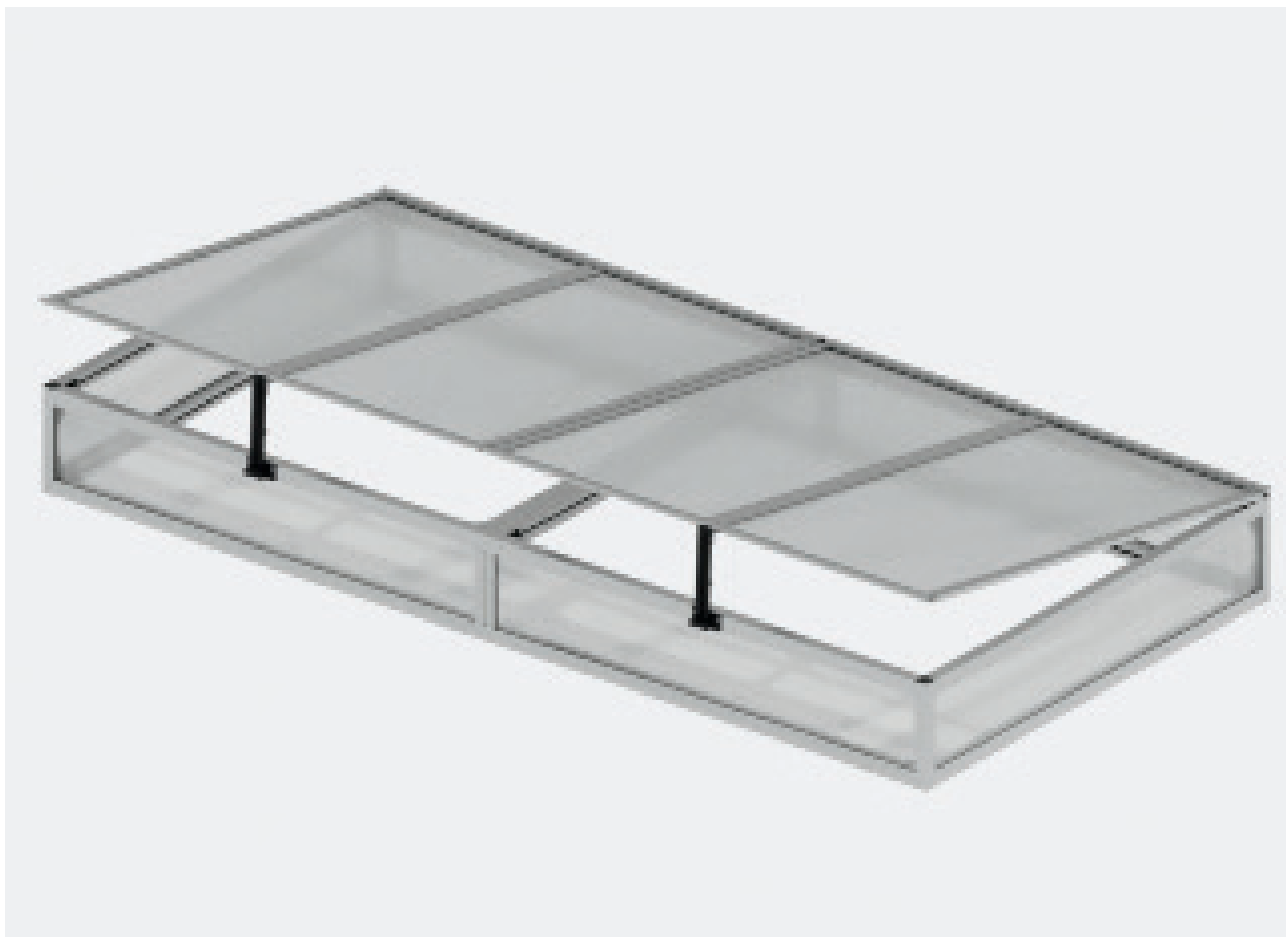

COLD FRAME ATTACHMENTS with 77 cm or 99 cm width



It is **essential** to read these instructions **before** assembly.

Assembly and safety instructions

Dear Customer,

You have acquired a meticulously constructed product, made by people for whom precision has become a tradition. The compact design allows for quick assembly. In addition, it is a very versatile product. We reserve the right to make further developments in the interest of technical progress. We ask for your understanding that minor deviations from the illustrations and descriptions may arise. We wish you every success with your new garden jewel.

PLEASE NOTE: Before assembly, identify the aluminium profiles and check the quantities and dimensions.

Before assembly, make sure that no parts are missing on the basis of the individual parts list. We are unable to pay any additional expenses paid to installation companies as a result of customers failing to conduct a proper inspection in advance of assembly.

If spare parts are required, please contact the seller. Please let them know the item number of the part you need.

With twin-wall sheets, it should be noted that there is an interior side and an exterior side. The glued side or the side labelled "outside" is covered with a UV-protective coating. To avoid confusion, always remove the foil after inserting each sheet.

CAUTION – Safety instructions for assembly!

We recommend wearing protective gloves, safety goggles and safety shoes when assembling the frame and glazing (risk of injury and breakage!). After complete assembly, all screw connections must be tightened again using a spanner.

NOTE!

The manufacturer is not liable for storm, wind, water or snow load damage (**we recommend that you remove snow from the roof during the winter months**). The warranty does not cover compensation for consequential damage or financial loss. If there is visible damage to components, they must be replaced with original spare parts.

TOOL LIST:

The following tools are required for assembly:



EXPLANATION OF SIGNS AND TERMS:

The following symbols are used in our assembly instructions:



Attention!
Important!



This
component



component is
moved!



1
Assembly
order

WARRANTY POLICY INSTRUCTIONS:

We give a one-year warranty on the item specified in the instructions in the event that our product is defective. The annual period begins with the acceptance of the product by the customer. A prerequisite for the assertion of the warranty is proper maintenance in accordance with the assembly instructions as well as the intended use of the item. You of course retain the statutory warranty rights within this year.

In addition, we grant you a 10-year warranty on aluminium frame parts in accordance with the following conditions:

The warranty period starts on the date of delivery, which must be evidenced by the proof of purchase, such as invoice, delivery note or copy.

Exclusion: The warranty period does not apply to natural wear and tear or transport damage, as well as to environmental damage caused by hail, wind or snow, nor to damage caused by non-compliance with the assembly instructions and non-standard installation, use of materials that are not original ones, mechanical damage, the influence of chemicals, natural disasters and other violent influences. The manufacturer is not liable for any indirect consequential and financial damage. Repair work does not renew or extend the warranty period. The manufacturer reserves the right to make decisions on the manner in which warranty claims are settled. For warranty claims, malfunctions or spare parts requirements, please contact your specialist dealer.

The roof of your cold frame attachment must be cleared of snow and ice during the winter months!

IMPORTANT INFORMATION

CHECKING PARTS LISTS

We strongly recommend checking the parts of the frame as well as the twin-wall sheets for completeness on the basis of the parts list. With the guarantee that all parts are completely available, a continuous structure is ensured and you save time and hassle of having to stop assembly.

ATTENTION: To rule out shortfalls as far as possible, we use **the most modern weighing techniques**, and the individual packing steps are continuously and fully monitored by **exact weight checks**.

This allows us to largely rule out any shortages or any mixing up of parts.

However, if a part is damaged during transport, or if a part is missing, we will send it to you as quickly as possible.

IN EVENT OF QUESTIONS, CONTACT THE SELLER:

The manufacturer / importer is GFP Handels GesmbH, Passauerstr. 24, A-4070 Eferding, Austria (hereinafter also referred to as “the manufacturer“, “we“ or “us“).

If you have any questions about the assembly or the product itself, please contact the supplier through whom you purchased your product.

RETURNS POLICY FOR TWIN-WALL SHEETS

Sometimes when stapling the wall sheet cartons, **sheets** can be **slightly damaged at the side ends** by the stapler.







Please note that **twin-wall sheets normally do not have closed side edges** and this is a unique feature we offer.









Therefore, **minor damage** (any damage no longer visible either after insertion into aluminium profiles or after attachment of the plastic clips – i.e., no longer visible **further than approx. 7 mm** into the sheet) **do not constitute grounds for complaint**, since neither the function nor the appearance is impaired as a result.

Exchanging plates of this type is **only possible after returning the original plates!**

Parts lists

Cold frame attachment, 119 x 77 cm





SKETCH	PART. NO.	DESIGNATION	LENGTH	QTY.
	101018	Top/bottom profile	677 mm	4
	101279	Top/bottom profile	1102 mm	4
	101300	Corner profile	196 mm	4
	101251	Roof hinge	1102 mm	1
	101230	Window hinge	574 mm	4
	101321	Window frame profile	693 mm	4
	101342	Centre ridge/support profile	677 mm	1

SKETCH	PART. NO.	DESIGNATION	LENGTH	QTY.
	200101	Corner connector		8
	200111	Edge protection - window		3
	200121	Cap		8
	200131	Stay		2
	200141	Window stay latch		2
	200151	Bracket		4
	200161	Fastening clip		8
	200171	Slide guard		2







Twin-wall sheets









		Twin-wall sheet, wall	160 x 700 mm	2
		Twin-wall sheet, wall	160 x 1125 mm	2
		Twin-wall sheet, window	543 x 705 mm	2

Screws

	690509	M6x12 screw		40
	690510	Flat-head screw, M6x16		4
	690547	M6 nut		44
	664753	Tapping screw, 4.2x22 (window)		8
	9040556	Drilling screw, 4.8x13 mm		16

Cold frame attachment, 119 x 99 cm





SKETCH	PART. NO.	DESIGNATION	LENGTH	QTY.
	101272	Top/bottom profile	902 mm	4
	101279	Top/bottom profile	1102 mm	4
	101300	Corner profile	196 mm	4
	101251	Roof hinge	1102 mm	1
	101230	Window hinge	574 mm	4
	101328	Window frame profile	918 mm	4
	101349	Centre ridge/support profile	902 mm	1

SKETCH	PART. NO.	DESIGNATION	LENGTH	QTY.
	200101	Corner connector		8
	200111	Edge protection - window		3
	200121	Cap		8
	200131	Stay		2
	200141	Window stay latch		2
	200151	Bracket		4
	200161	Fastening clip		8
	200171	Slide guard		2









Twin-wall sheets

		Twin-wall sheet, wall	160 x 925mm	2
		Twin-wall sheet, wall	160 x 1125 mm	2
		Twin-wall sheet, window	543 x 933mm	2

Screws

	690509	M6x12 screw		40
	690510	Flat-head screw, M6x16		4
	690547	M6 nut		44
	664753	Tapping screw, 4.2x22 (window)		8
	9040556	Drilling screw, 4.8x13 mm		16









Cold frame attachment, 150x77 cm

SKETCH	PART. NO.	DESIGNATION	LENGTH	QTY.
	101018	Top/bottom profile	677 mm	4
	101286	Top/bottom profile	1415 mm	4
	101300	Corner profile	196 mm	4
	101237	Window hinge	730 mm	4
	101321	Window frame profile	693 mm	4
	101342	Centre ridge/support profile	677 mm	1
	101258	Roof hinge	1415 mm	1
	101195	Centre profile	137 mm	2

Twin-wall sheets









		Twin-wall sheet, wall	160 x 700 mm	6
		Twin-wall sheet, window	700 x 705 mm	2

Cold frame attachment, 150 x 99 cm





SKETCH	PART. NO.	DESIGNATION	LENGTH	QTY.
	101272	Top/bottom profile	902 mm	4
	101286	Top/bottom profile	1415 mm	4
	101300	Corner profile	196 mm	4
	101237	Window hinge	730 mm	4
	101328	Window frame profile	918 mm	4
	101349	Centre ridge/support profile	902 mm	1
	101258	Roof hinge	1415 mm	1
	101195	Centre profile	137 mm	2









Twin-wall sheets

		Twin-wall sheet, wall	160 x 925mm	2
		Twin-wall sheet, wall	160 x 700 mm	4
		Twin-wall sheet, window	700 x 933 mm	2





SKETCH	PART. NO.	DESIGNATION	LENGTH	QTY.
	200101	Corner connector		8
	200111	Edge protection - window		3
	200121	Cap		8
	200131	Stay		2
	200141	Window stay latch		2
	200151	Bracket		4
	200161	Fastening clip		8
	200171	Slide guard		2

Screws

	690509	M6x12 screw		40
	690510	Flat-head screw, M6x16		4
	690547	M6 nut		44
	664753	Tapping screw, 4.2x22 (window)		8
	9040556	Drilling screw, 4.8x13 mm		16

SKETCH	PART. NO.	DESIGNATION	LENGTH	QTY.
	200101	Corner connector		8
	200111	Edge protection - window		3
	200121	Cap		8
	200131	Stay		2
	200141	Window stay latch		2
	200151	Bracket		4
	200161	Fastening clip		8
	200171	Slide guard		2

Screws

	690509	M6x12 screw		40
	690510	Flat-head screw, M6x16		4
	690547	M6 nut		44
	664753	Tapping screw, 4.2x22 (window)		12
	9040556	Drilling screw, 4.8x13 mm		16

Parts lists

Cold frame attachment, 195 x 77 cm

SKETCH	PART. NO.	DESIGNATION	LENGTH	QTY.
	101018	Top/bottom profile	677 mm	4
	101293	Top/bottom profile	1865 mm	4
	101300	Corner profile	196 mm	4
	101244	Window hinge	955 mm	4
	101321	Window frame profile	693 mm	4
	101342	Centre ridge/support profile	677 mm	1
	101265	Roof hinge	1865 mm	1
	101195	Centre profile	137 mm	2
	101216	Glazing bar	693 mm	2

Twin-wall sheets









		Twin-wall sheet, wall	160 x 700 mm	2
		Twin-wall sheet, wall	160 x 925mm	4
		Twin-wall sheet, window	447 x 705 mm	4

Cold frame attachment, 195 x 99 cm





SKETCH	PART. NO.	DESIGNATION	LENGTH	QTY.
	101272	Top/bottom profile	902 mm	4
	101293	Top/bottom profile	1865 mm	4
	101300	Corner profile	196 mm	4
	101244	Window hinge	955 mm	4
	101328	Window frame profile	918 mm	4
	101349	Centre ridge/support profile	902 mm	1
	101265	Roof hinge	1865 mm	1
	101195	Centre profile	137 mm	2
	101223	Glazing bar	918 mm	2









Twin-wall sheets

		Twin-wall sheet, wall	160 x 925mm	6
		Twin-wall sheet, window	447 x 933 mm	4





SKETCH	PART. NO.	DESIGNATION	LENGTH	QTY.
	200101	Corner connector		8
	200111	Edge protection - window		3
	200121	Cap		8
	200131	Stay		2
	200141	Window stay latch		2
	200151	Bracket		4
	200161	Fastening clip		8
	200171	Slide guard		2

Screws

	690509	M6x12 screw		40
	690510	Flat-head screw, M6x16		4
	690547	M6 nut		44
	664753	Tapping screw, 4.2x22 (window)		12
	9040556	Drilling screw, 4.8x13 mm		16

SKETCH	PART. NO.	DESIGNATION	LENGTH	QTY.
	200101	Corner connector		8
	200111	Edge protection - window		3
	200121	Cap		8
	200131	Stay		2
	200141	Window stay latch		2
	200151	Bracket		4
	200161	Fastening clip		8
	200171	Slide guard		2

Screws

	690509	M6x12 screw		40
	690510	Flat-head screw, M6x16		4
	690547	M6 nut		44
	664753	Tapping screw, 4.2x22 (window)		12
	9040556	Drilling screw, 4.8x13 mm		16

Step 1 - Assembling the base frame

STEP 1 - Assembling the base frame

In the first step, the base frame is made from the two longitudinal and cross profiles "top/bottom profile".

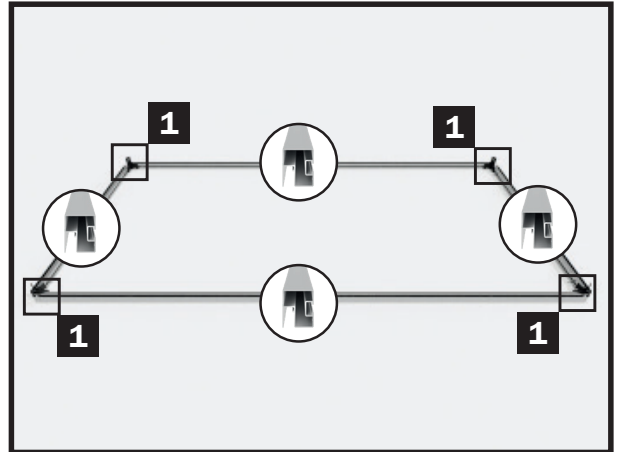

1a



Position the four profiles of the base frame. Pick up four M6x12 mm screws and four M6 nuts.

Make sure that the formed "U" points upwards!

1b



Insert two M6x12 mm screws each into the screw channel of the profiles.

1c



Position the two profiles together so that they meet at the corners. Pick up a corner connector.

1d



Position the corner connector so that one M6x12 mm screw protrudes through each leg of the corner connector.

1e

Exterior view



Check again that the profiles meet exactly at the corners.

1f

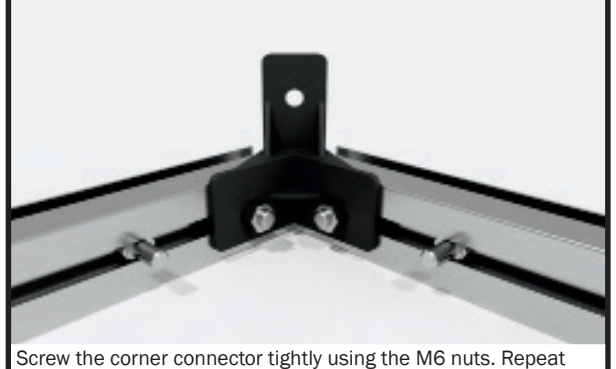

Screw the corner connector tightly using the M6 nuts. Repeat these steps for the remaining three corners.

Step 2 – Assembling the corner posts

STEP 2 – Assembling the corner posts

In the second assembly step, the corner profiles are fitted at the four corners.

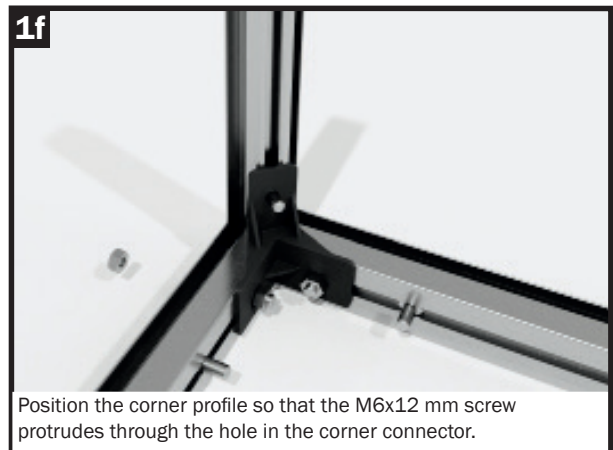
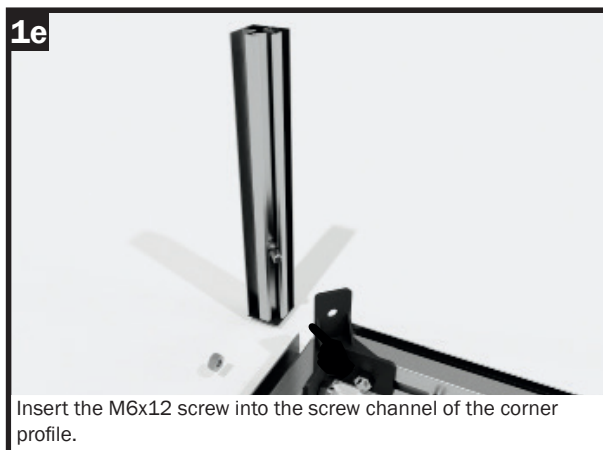
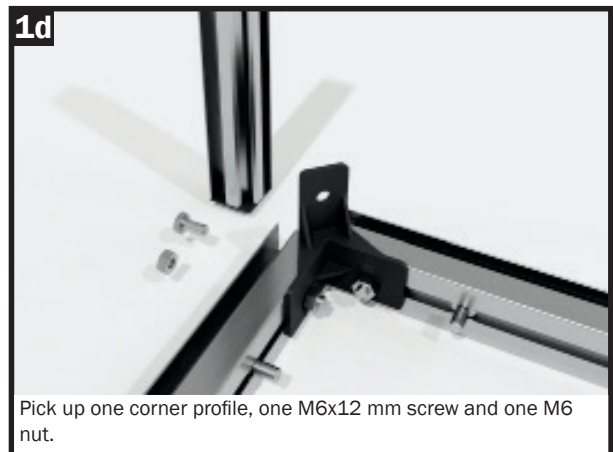
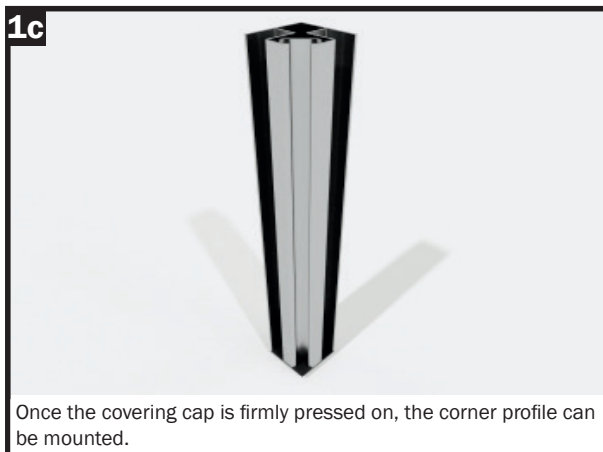
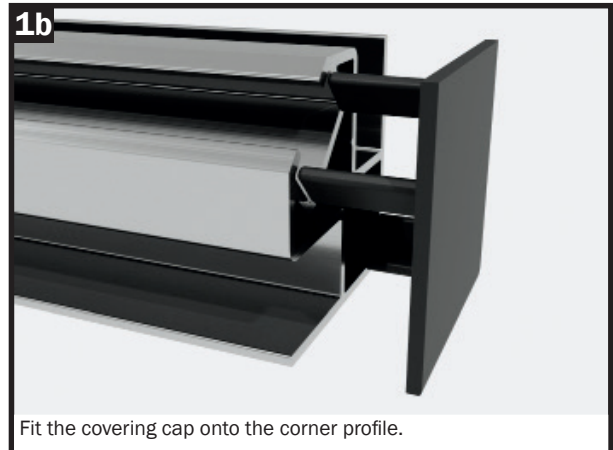
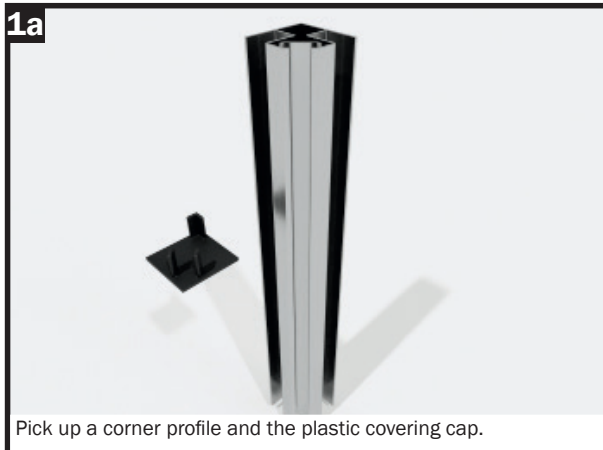
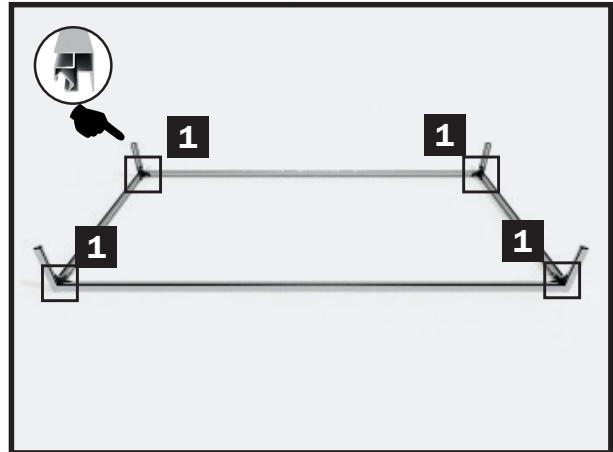

Step 3 – Glazing the side walls



STEP 3 – Glazing the side walls

In the third assembly step, the twin-wall sheets are inserted into the side walls.

When installing the wall sheets, pay attention to the inside and outside. The outside either has lettering or a foil.

! IMPORTANT

The wall sheets (height: 160 mm) are UV-stabilised on both sides and **can therefore be installed as desired!**

NOTE

Where the length of a wall is 119 cm or more, the twin-wall sheets are divided and are connected centrally to a coupling profile.

You can therefore leave out the following steps 2a and 2b for shorter sheets.

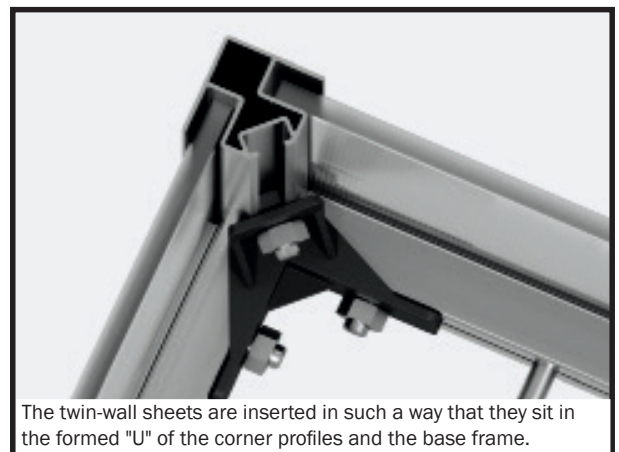
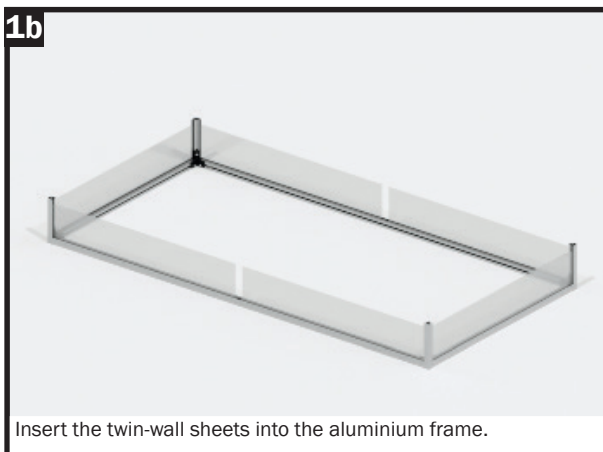
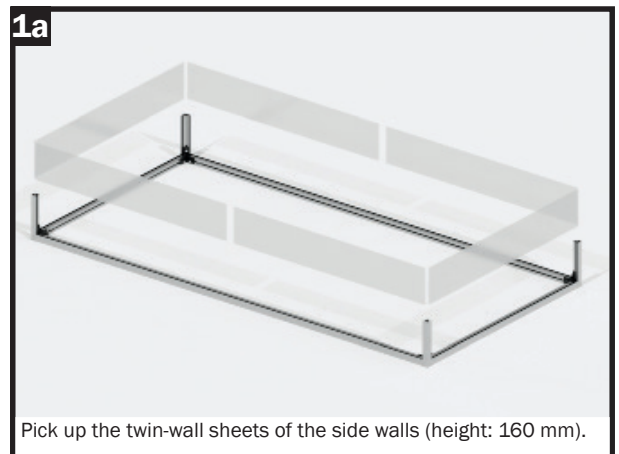
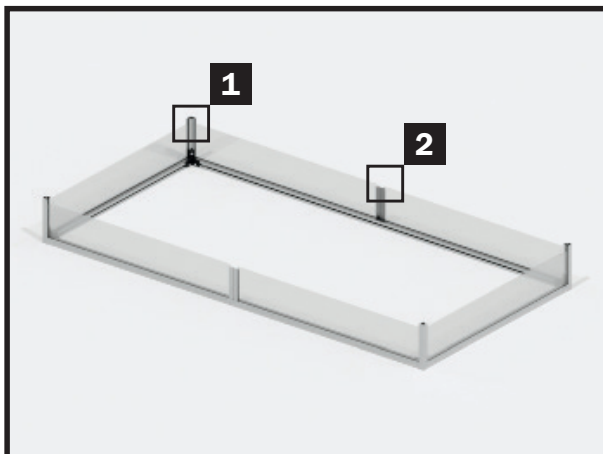

Step 4 – Attaching the top wall profiles

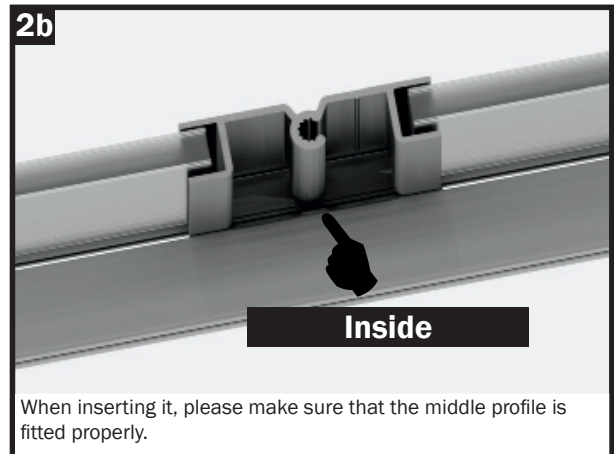
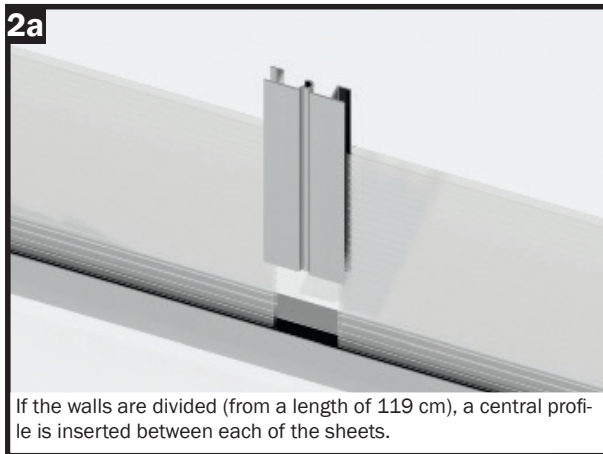

STEP 4 – Attaching the top wall profiles

In the fourth assembly step, the top profiles of the cold frame attachment are attached.

NOTE:

Later, a support profile is attached to the long side of the cold frame.

Please note that for the longer profile, two M6x12 mm screws are inserted at each end.

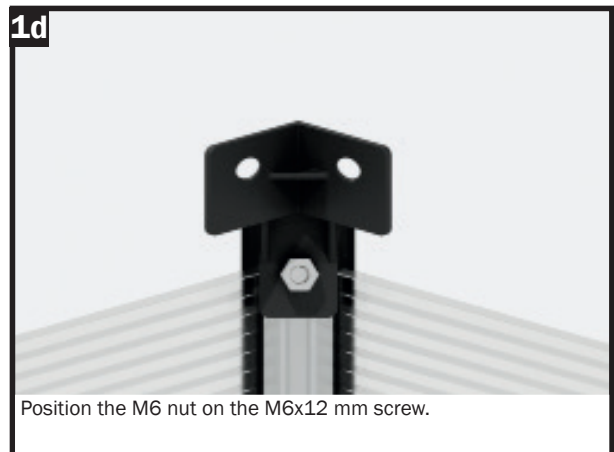
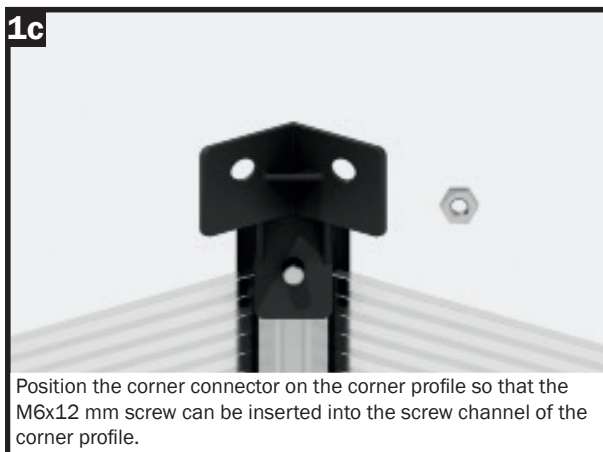
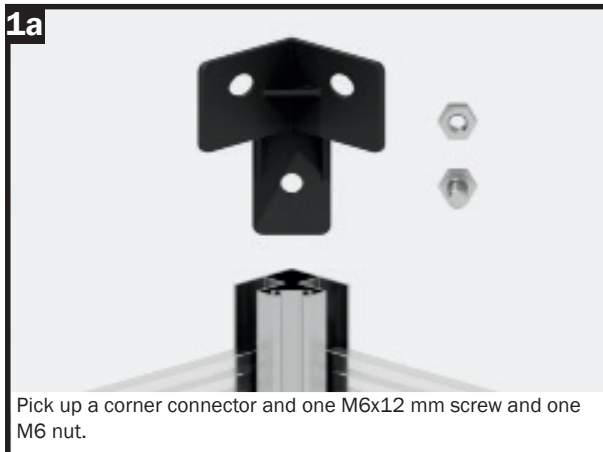
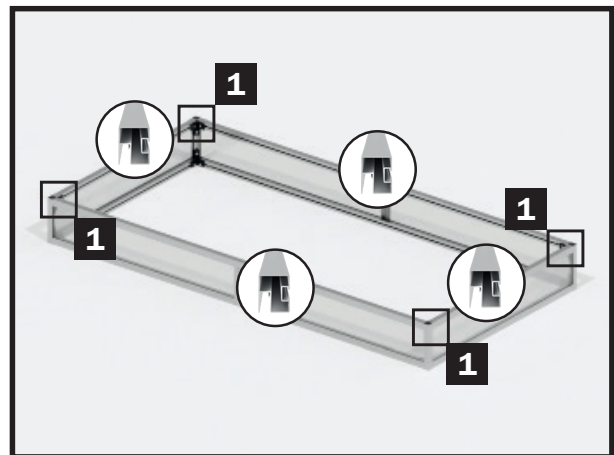

Step 4 – Attaching the top wall profiles

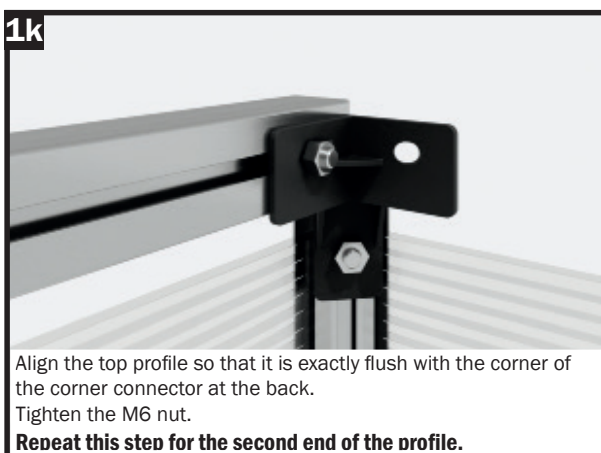
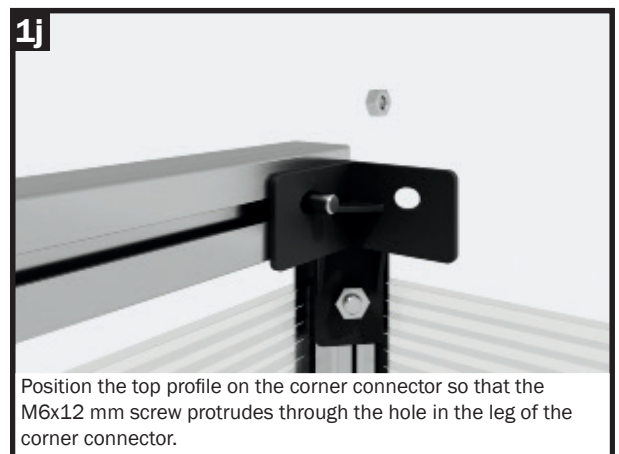
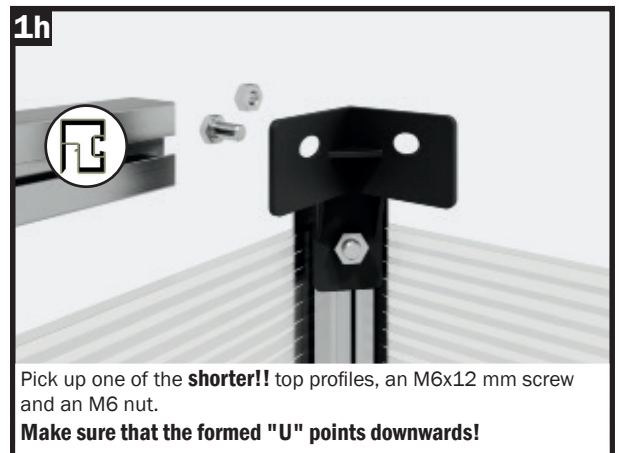
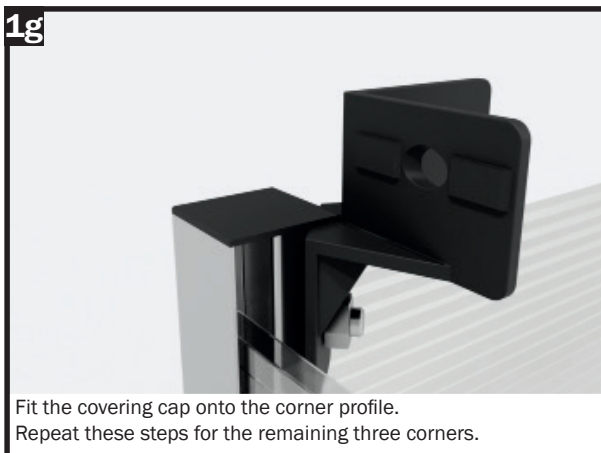
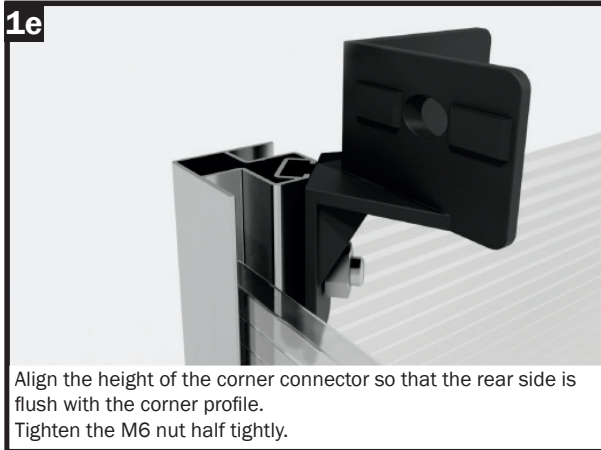

Step 4 – Attaching the top wall profiles

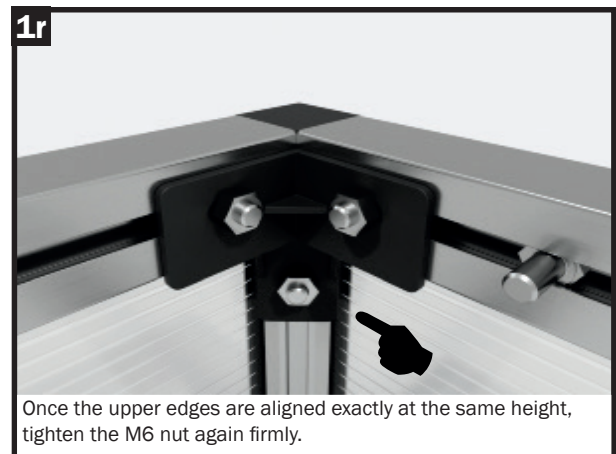
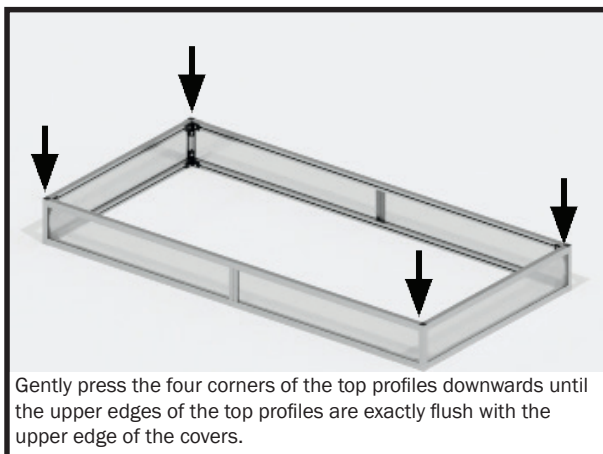
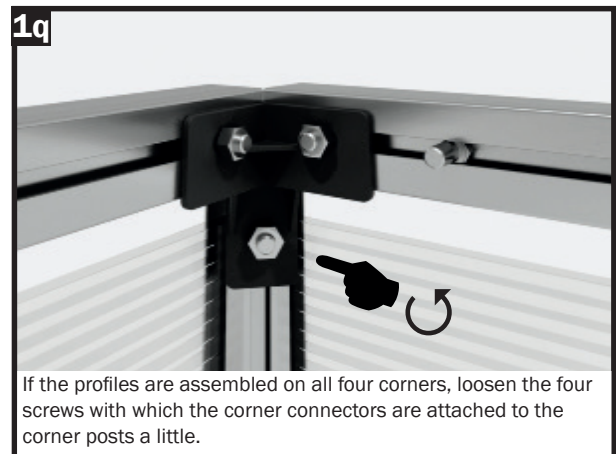
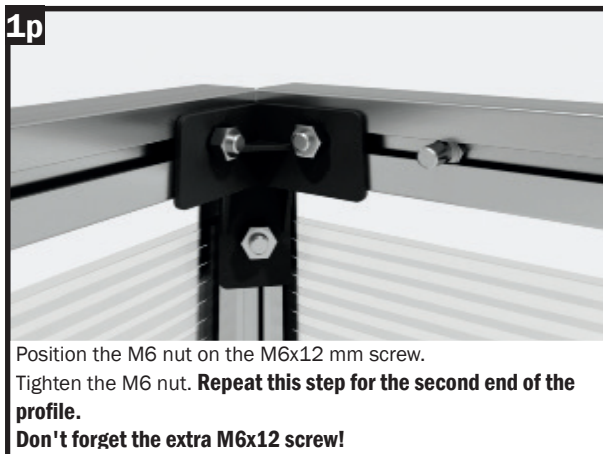
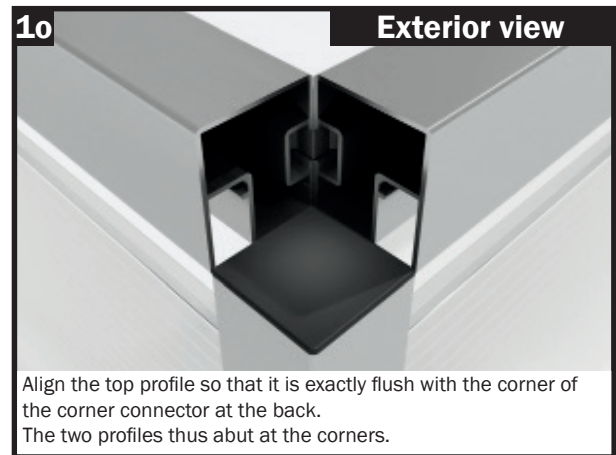
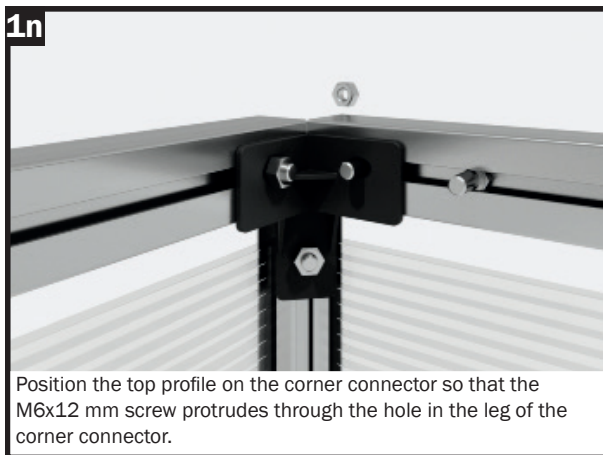
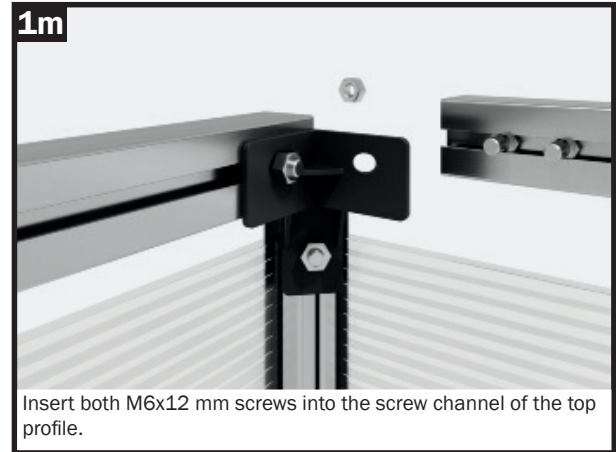
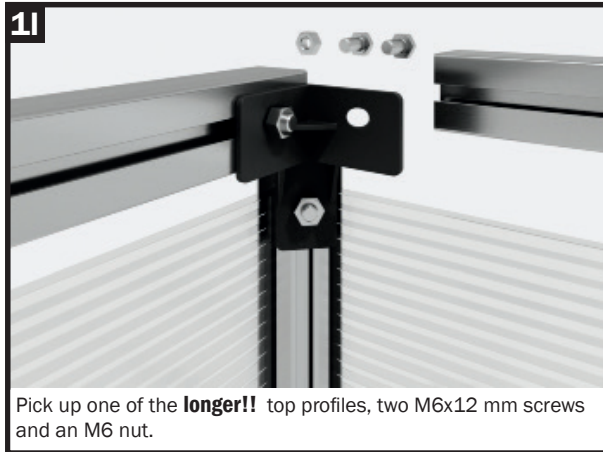

Step 5 – Assembling the window support profile

STEP 5 – Assembling the window support profile

In the fifth assembly step, the window support profile is attached to the cold frame.

It is important that assembly work is carried out exactly in the middle!

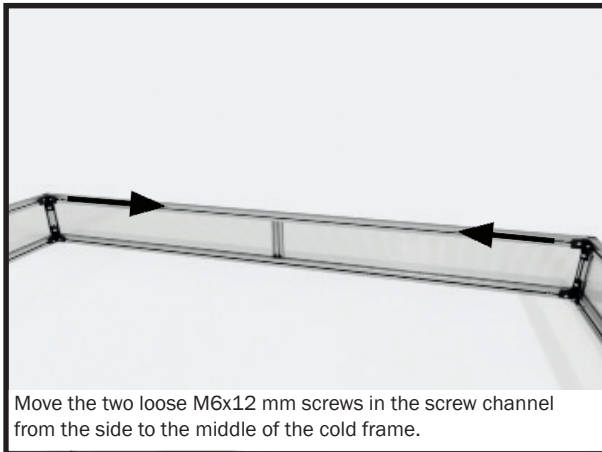
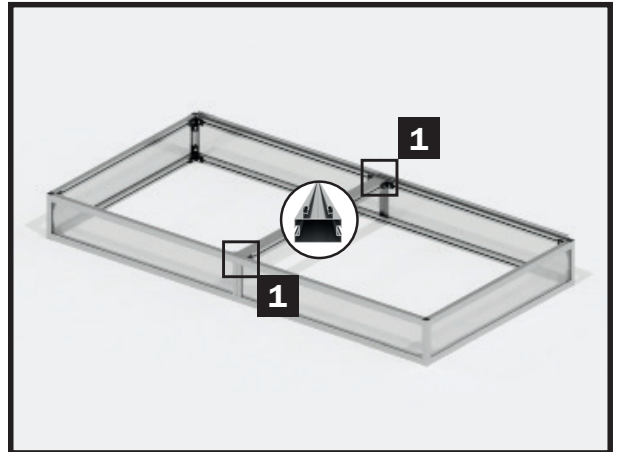

Move the two loose M6x12 mm screws in the screw channel from the side to the middle of the cold frame.

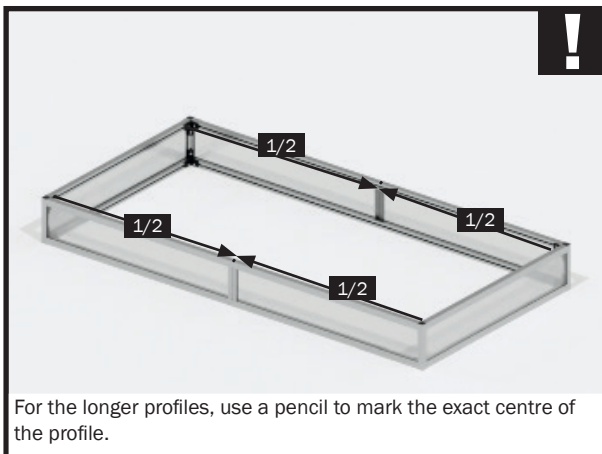
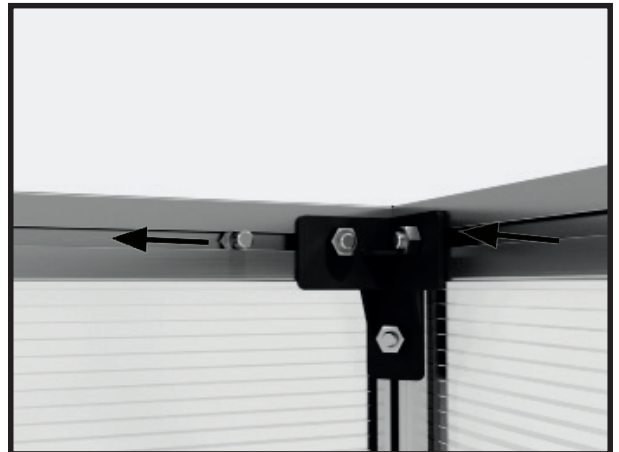

For the longer profiles, use a pencil to mark the exact centre of the profile.

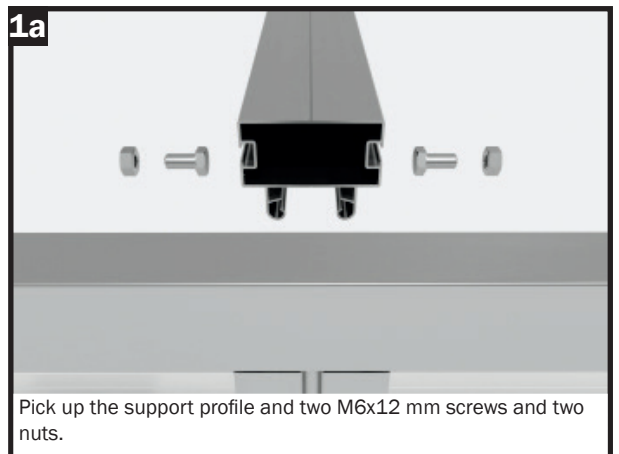

Pick up the support profile and two M6x12 mm screws and two nuts.

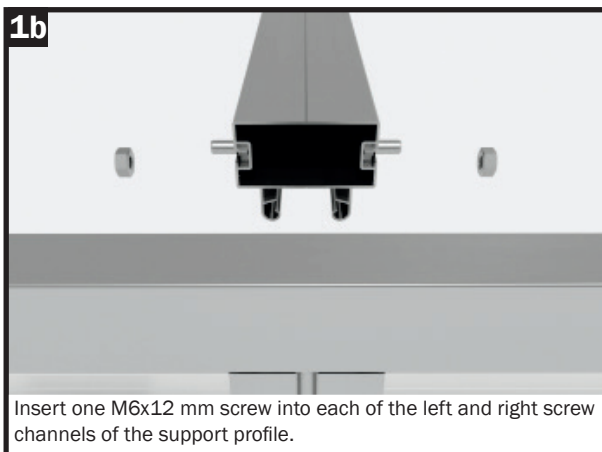

Insert one M6x12 mm screw into each of the left and right screw channels of the support profile.

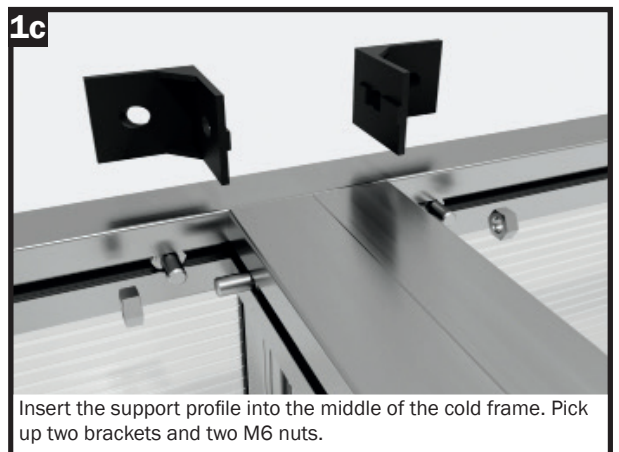

Insert the support profile into the middle of the cold frame. Pick up two brackets and two M6 nuts.

Step 5 – Assembling the window support profile and the roof hinge

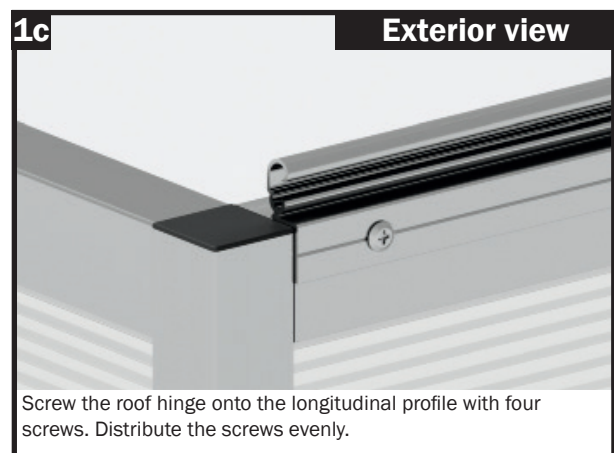
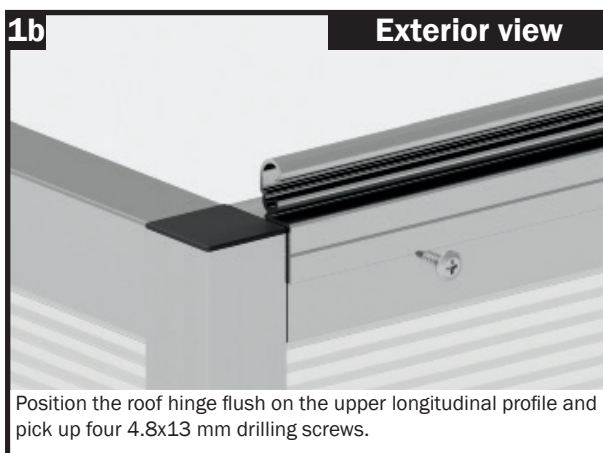
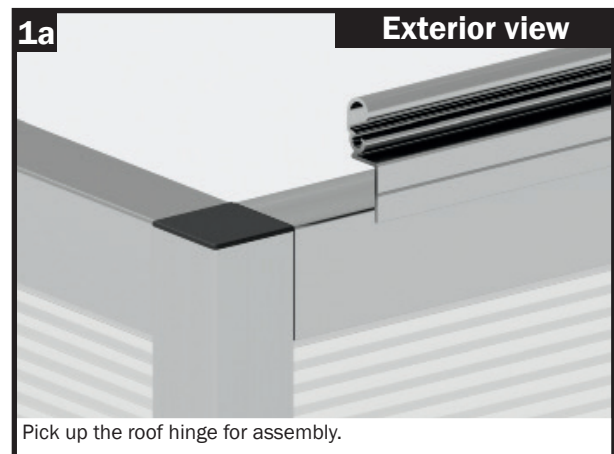
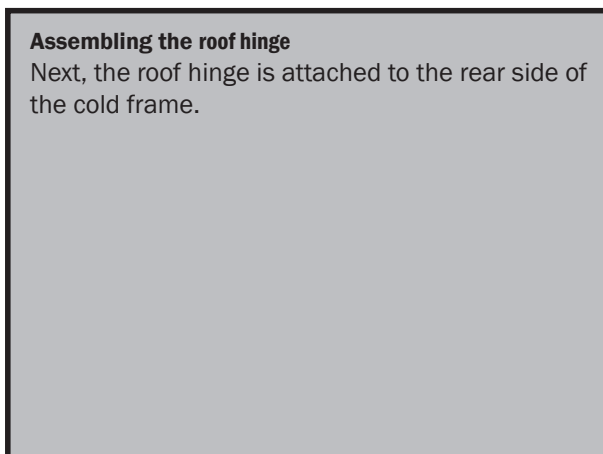
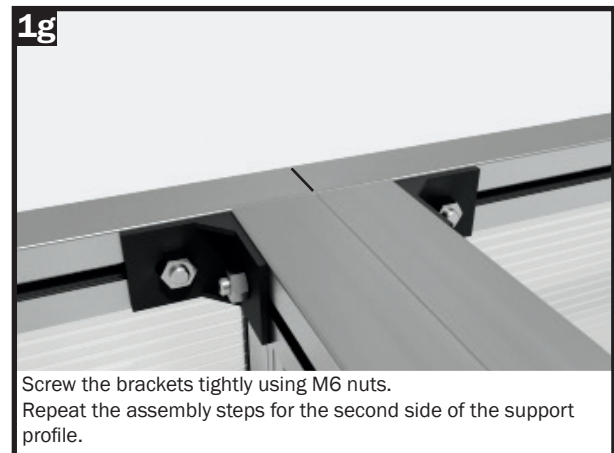
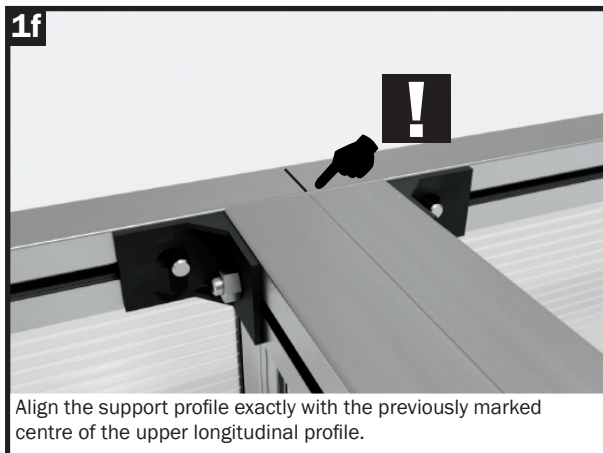
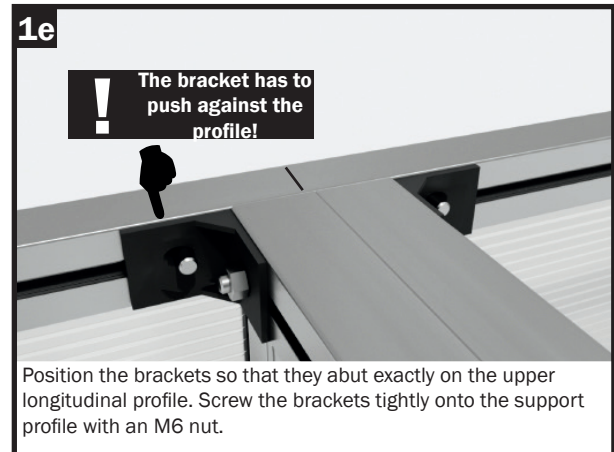
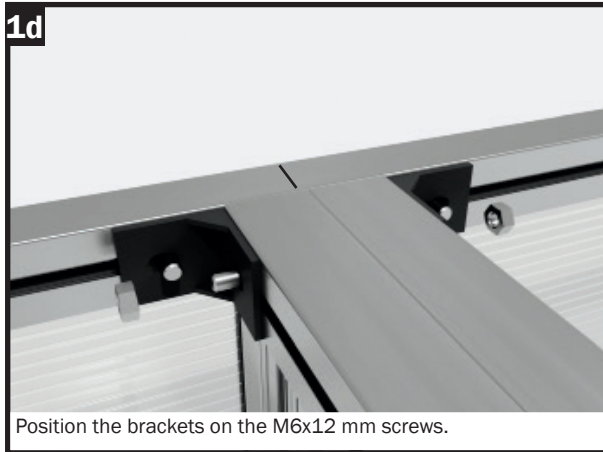

Step 6 – Assembling and installing the windows

STEP 6 – Assembling and installing the windows

In the seventh assembly step, the windows are assembled and glazed.
The windows are then inserted.

NOTE

For cold frames with a length of 195 cm, a glazing bar is inserted into the window. The assembly is shown in Figure 2.

These steps are not required for models with a length of 119 cm and 150 cm!

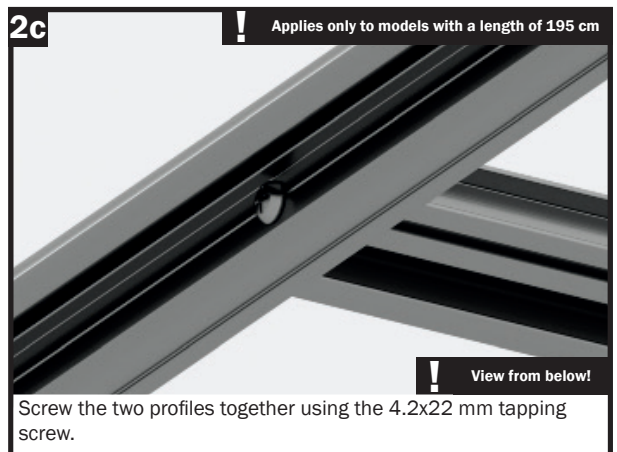
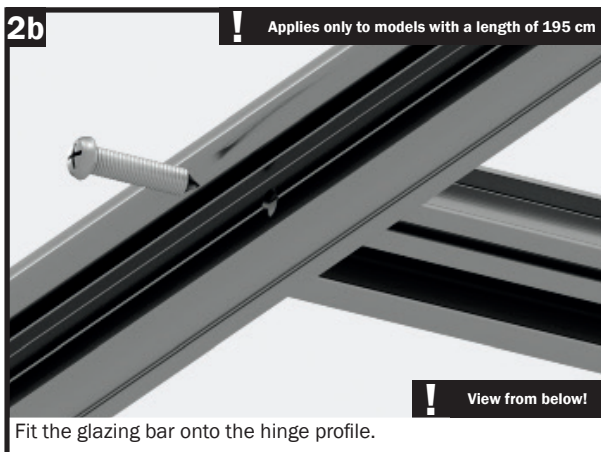
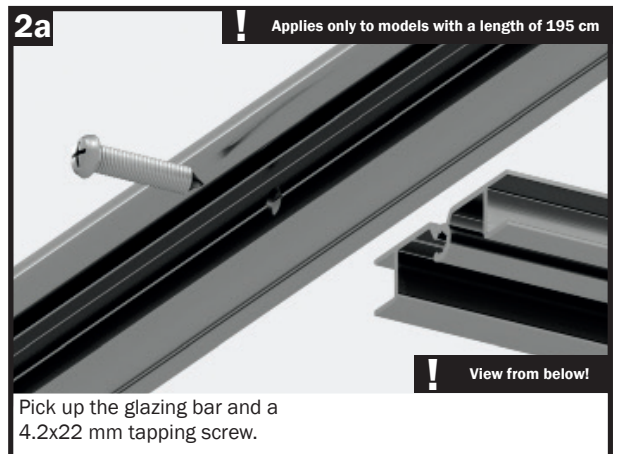
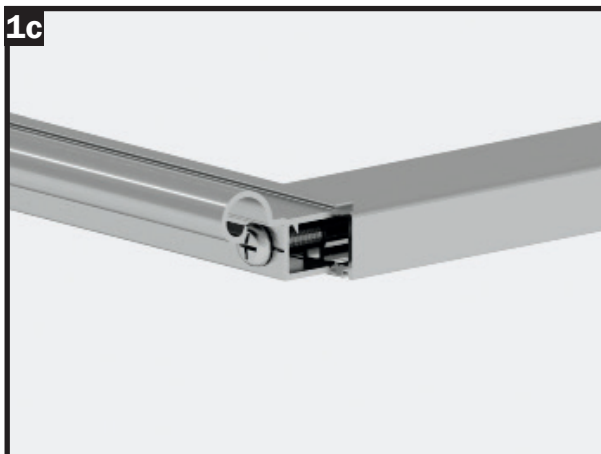
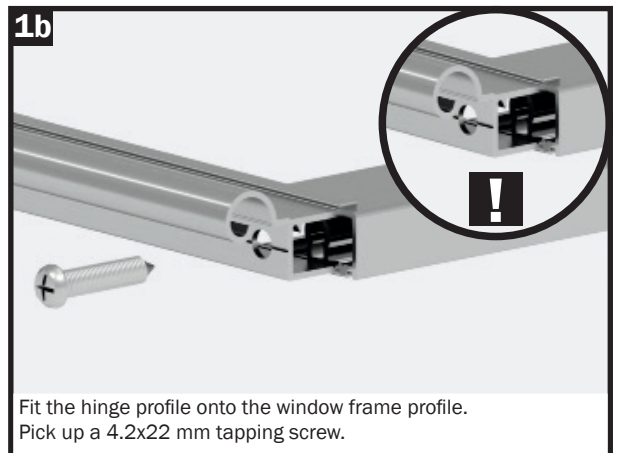
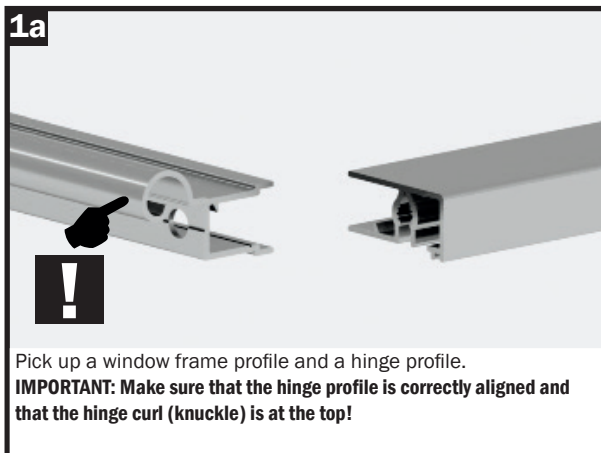
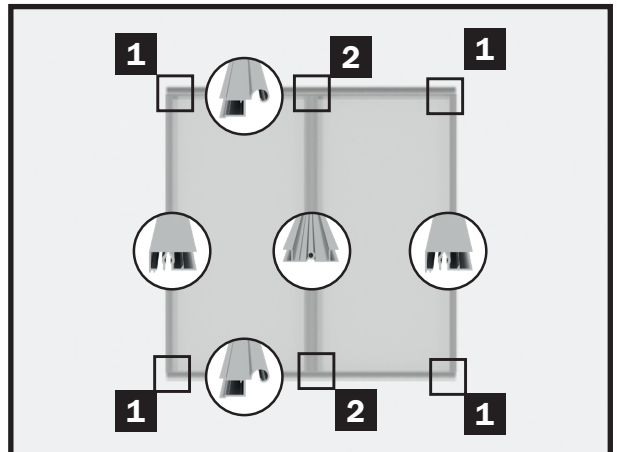

Step 6 – Assembling and installing the windows

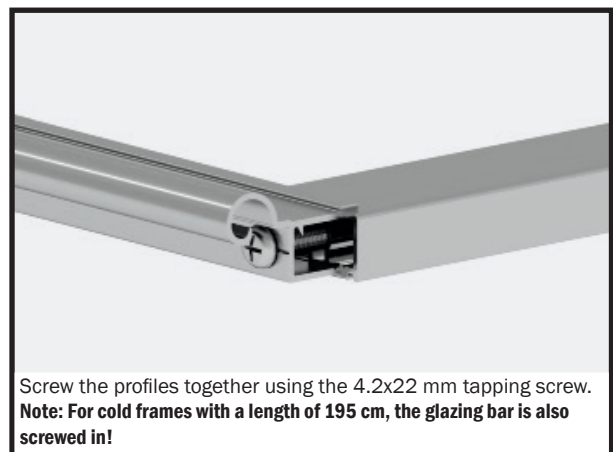
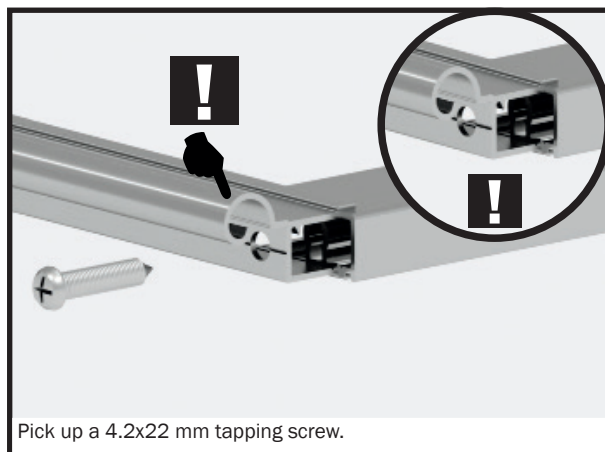
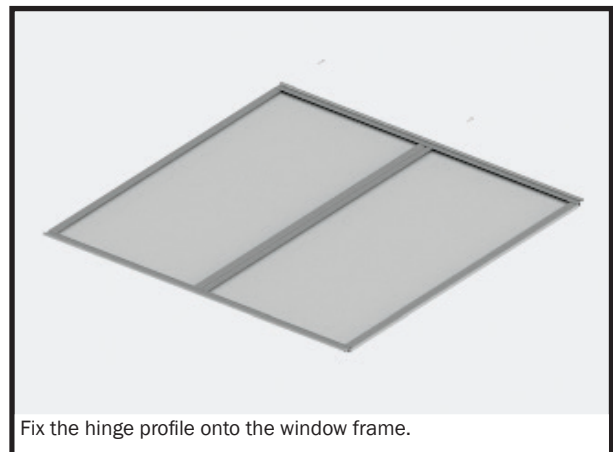
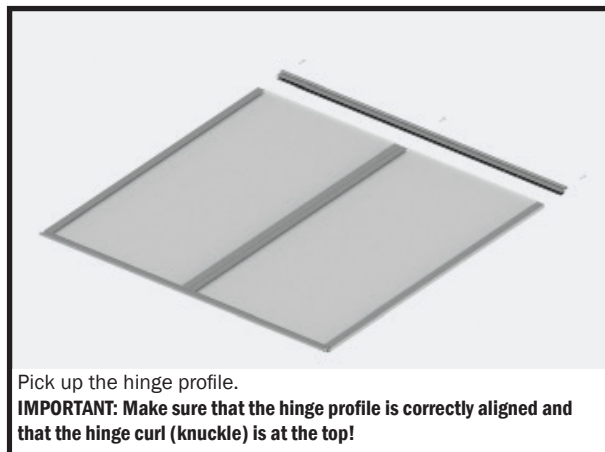
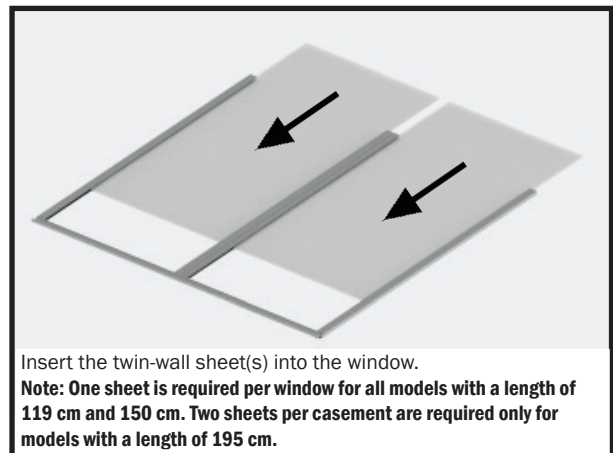
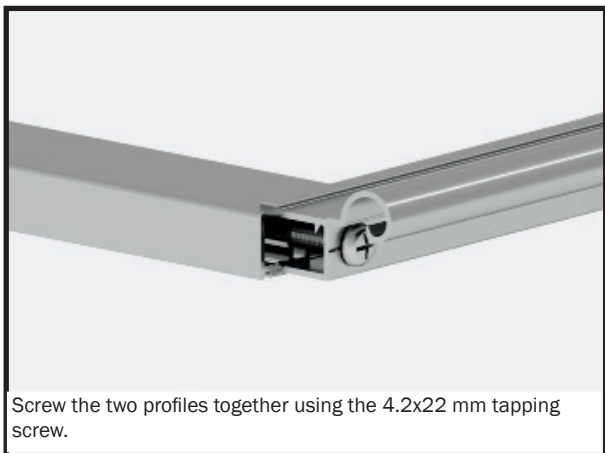
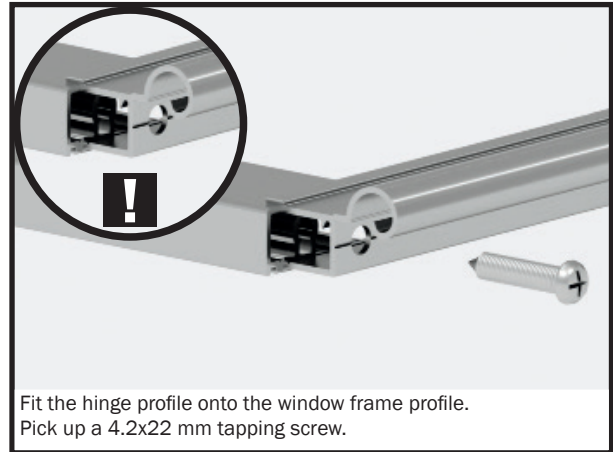
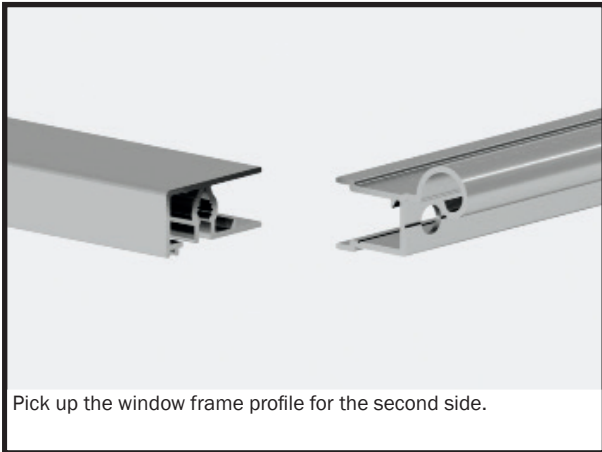

Step 6 – Assembling and installing the windows

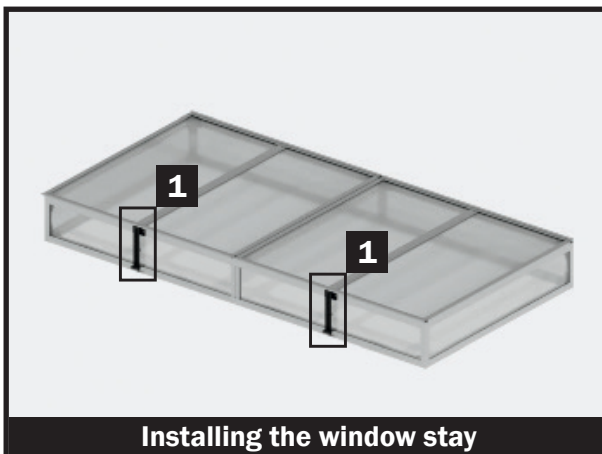
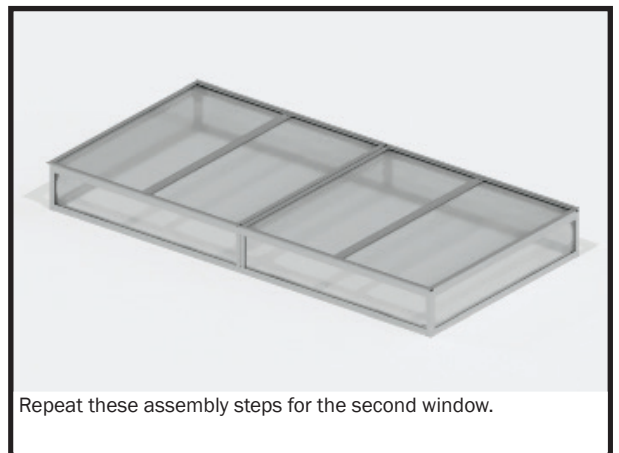
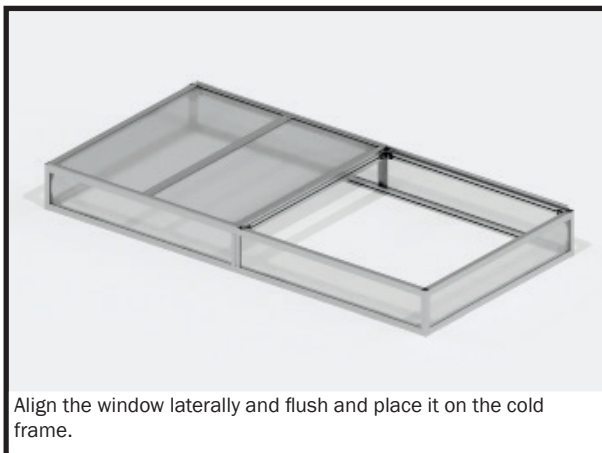
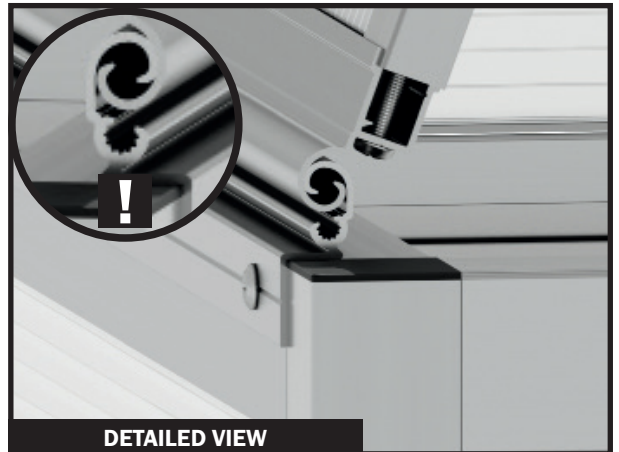
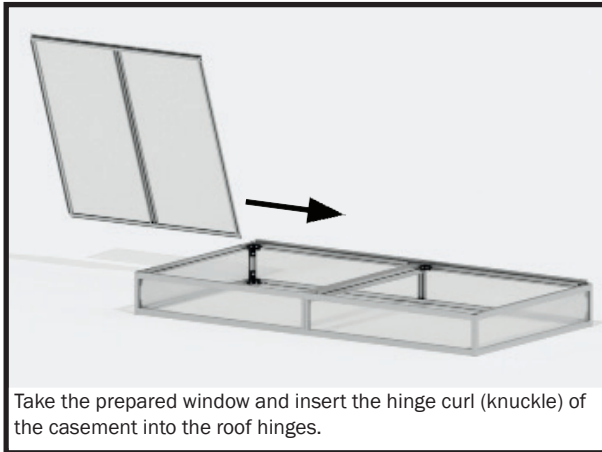

Step 6 – Assembling and installing the windows

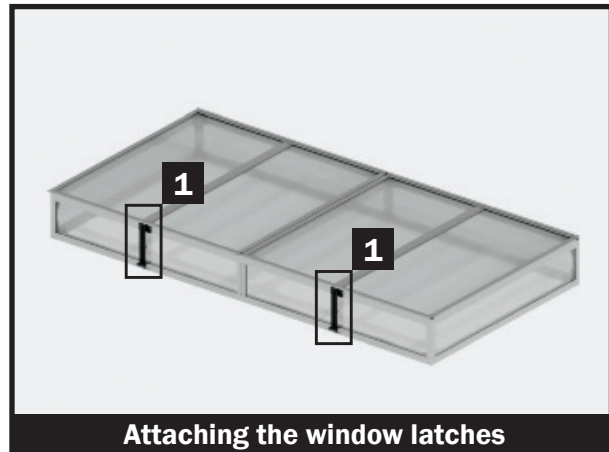
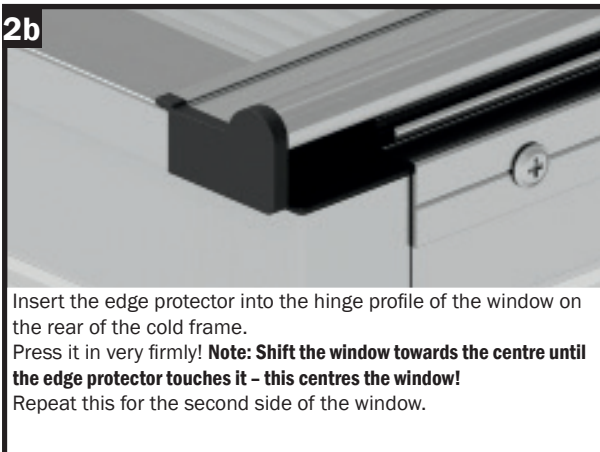
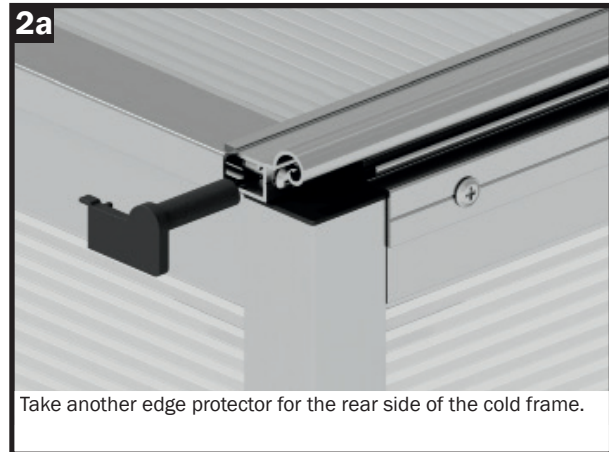
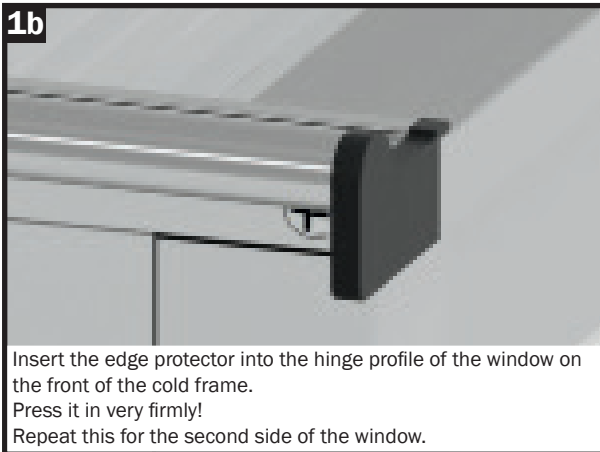
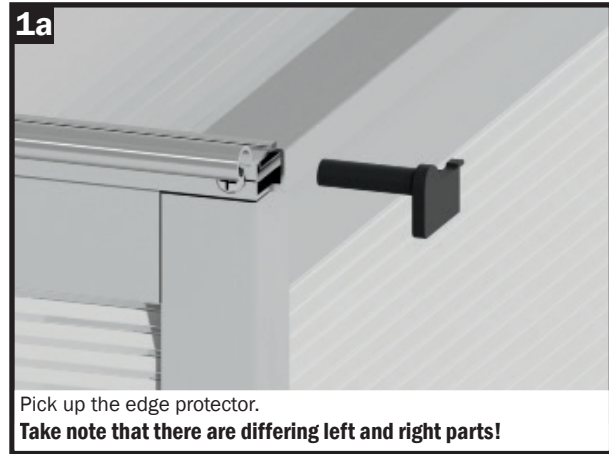
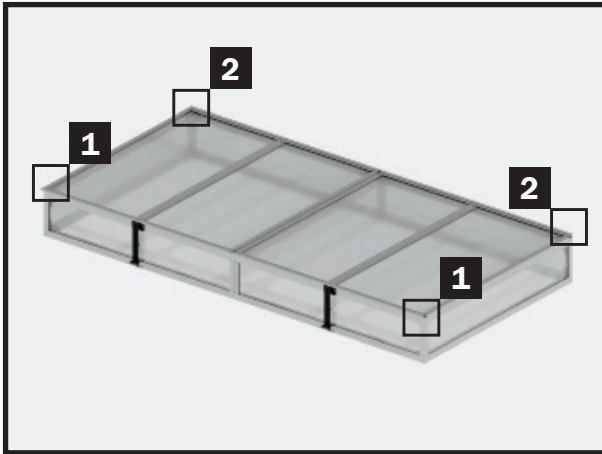

Step 6 – Assembling and installing the windows

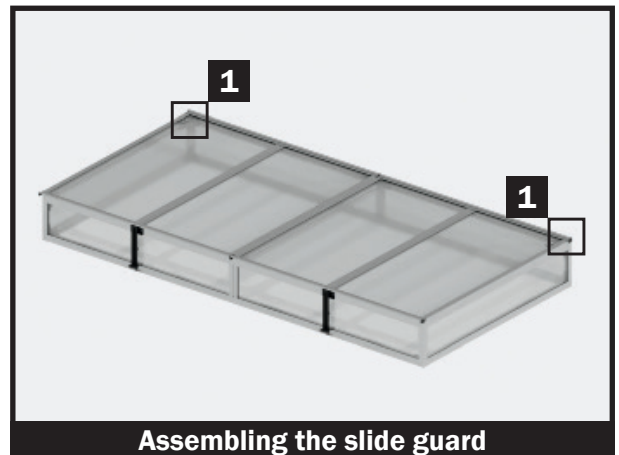
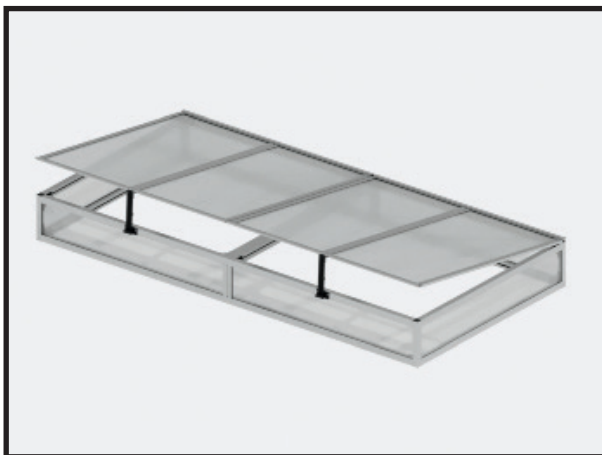

The slide guard prevents the window from sliding outwards in an uncontrolled manner when using the cold frame on a day-to-day basis.

NOTE:
The slide guard is screwed directly onto the twin-wall sheet.

To do this, drill two 7 mm holes through the twin-wall sheet on the left and right of the window. The dimensions can be found in the sketch on the side.

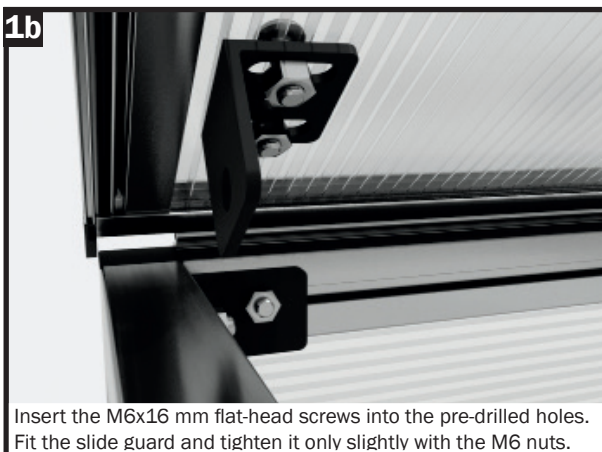
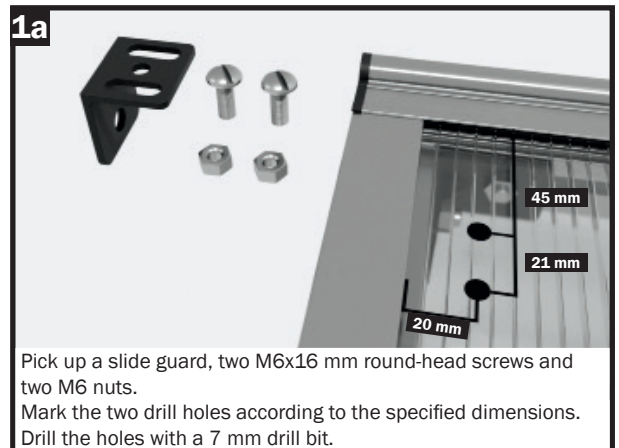

! NOTE

The slide guard is provided with oblong holes so that it can be optimally adjusted.

Simply press the window gently towards the centre until it touches the edge protector.

Then adjust the slide guard and carefully tighten the screws.

Step 6 – Assembling and installing the windows

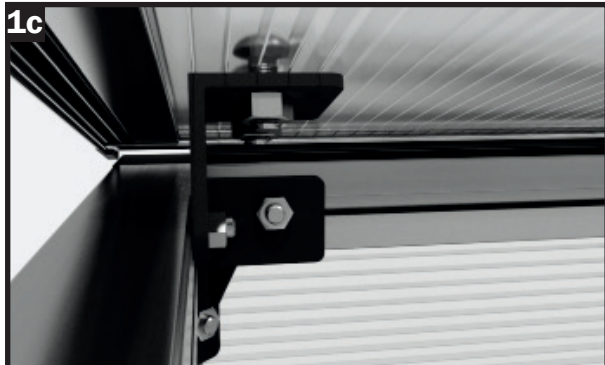

1c

After the window has been exactly aligned, set up the slide guard so that it abuts exactly on the upper aluminium profile of the cold frame.

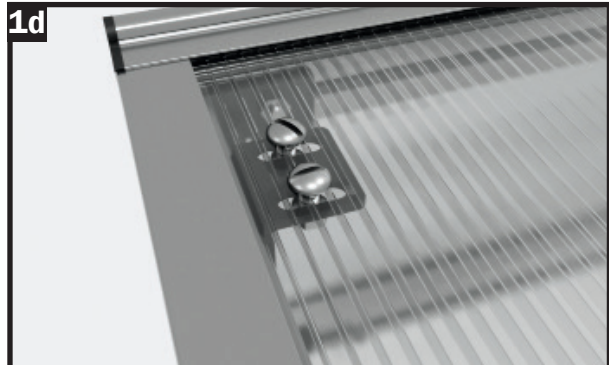

1d

Carefully tighten the M6 nuts so that the slide guard can no longer shift. The window will be in a perfect position when it is closed.

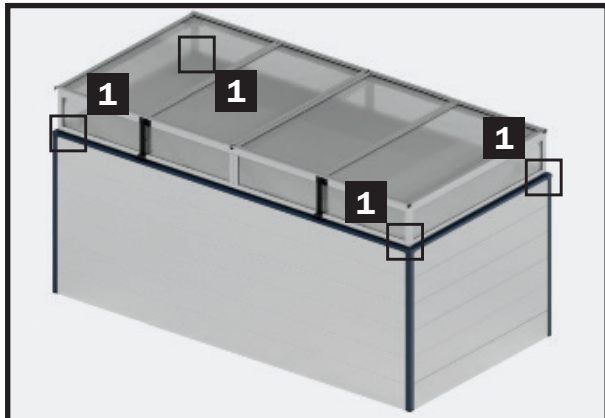

Placing it on the raised garden bed

PLACING THE COLD FRAME ON THE RAISED GARDEN BED

The cold frame is now placed on the raised garden bed and screwed twice to the fastening clips at each of the four corners.

! NOTE:

If you have opted for a raised garden bed without snail protection, the inner edge of the cold frame protrudes about 5 mm into the raised garden bed.

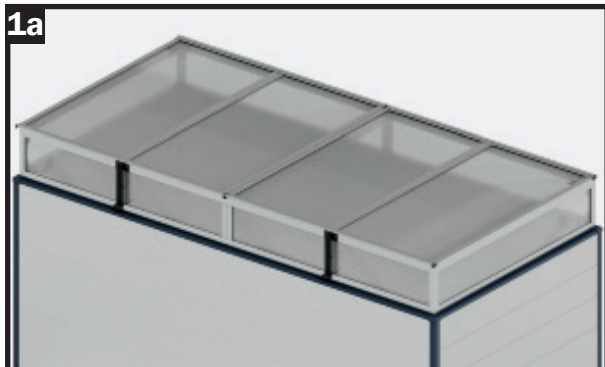

1a

Position the prepared cold frame attachment on the aluminium raised garden bed and align it so that it is positioned centrally on the raised garden bed.

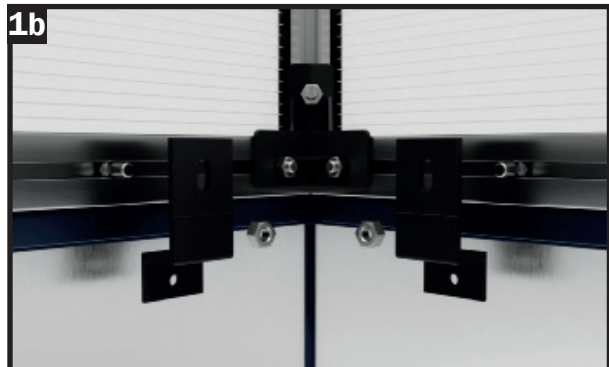

1b

Pick up two fastening clips and two M6 nuts.

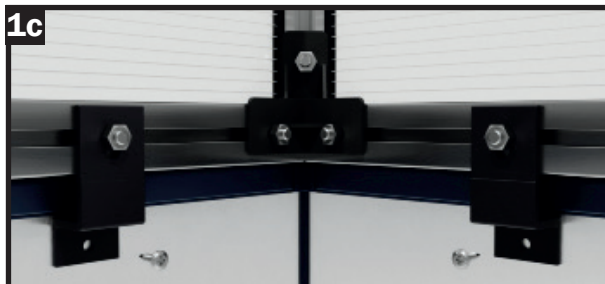

1c

Position the fastening clips on the M6x12 mm screws. Position them at a distance of about 10 cm from the corner. Adjust the cold frame attachment so that the fastening clips are fitted against the raised garden bed. Screw the fastening clips with M6 nuts. Pick up two 4.8x13 mm self-drilling tapping screws.

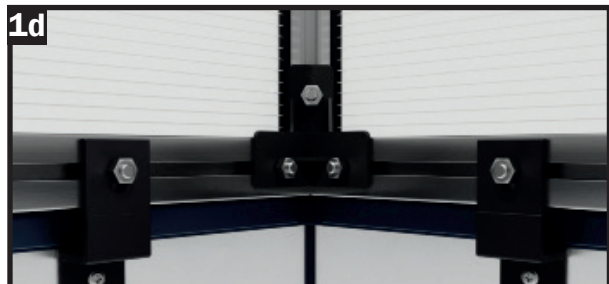

1d

Screw the fastening clips tightly onto the raised garden bed. Do the same for the other corners. The ideal sequence is to begin with two diagonally opposite corners.