

ASSEMBLY INSTRUCTIONS

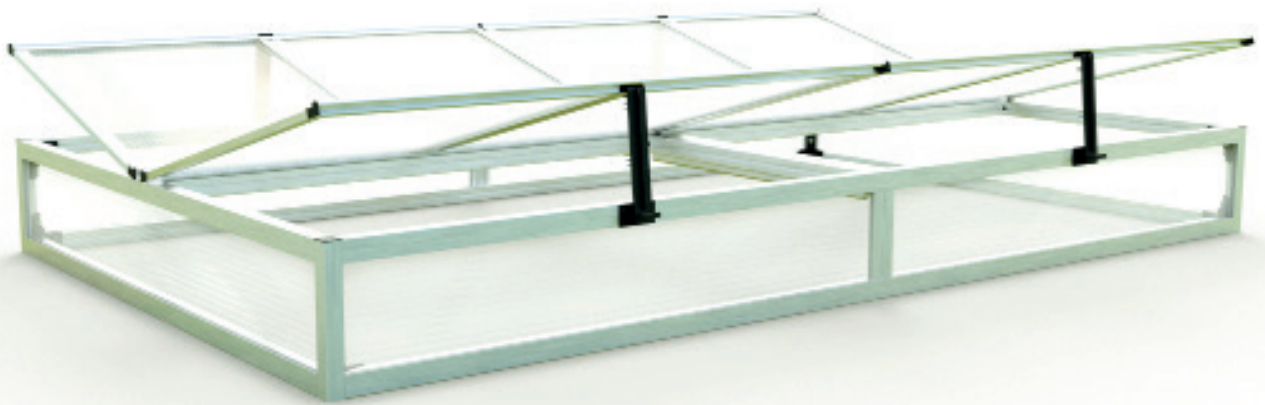

COLD FRAME ATTACHMENTS with 119 cm or 150 cm width



It is **essential** to read these instructions **before** assembly.

Assembly and safety instructions

Dear Customer,

You have acquired a meticulously constructed product, made by people for whom precision has become a tradition. The compact design allows for quick assembly. In addition, it is a very versatile product. We reserve the right to make further developments in the interest of technical progress. We ask for your understanding that minor deviations from the illustrations and descriptions may arise. We wish you every success with your new garden jewel.

PLEASE NOTE: Before assembly, identify the aluminium profiles and check the quantities and dimensions. Before assembly, make sure that no parts are missing on the basis of the individual parts list. We are unable to pay any additional expenses paid to installation companies as a result of customers failing to conduct a proper inspection in advance of assembly.

If spare parts are required, please contact the seller. Please let them know the item number of the part you need.

With twin-wall sheets, it should be noted that there is an interior side and an exterior side. The glued side or the side labelled "outside" is covered with a UV-protective coating. To avoid confusion, always remove the foil after inserting each sheet.

CAUTION – Safety instructions for assembly!

We recommend wearing protective gloves, safety goggles and safety shoes when assembling the frame and glazing (risk of injury and breakage!). After complete assembly, all screw connections must be tightened again using a spanner.

NOTE!

The manufacturer is not liable for storm, wind, water or snow load damage (**we recommend that you remove snow from the roof during the winter months**). The warranty does not cover compensation for consequential damage or financial loss. If there is visible damage to components, they must be replaced with original spare parts.

TOOL LIST:

The following tools are required for assembly:



EXPLANATION OF SIGNS AND TERMS:

The following symbols are used in our assembly instructions:



Attention!
Important!



This
component



component is
moved!



1
Assembly
order

WARRANTY POLICY INSTRUCTIONS:

We give a one-year warranty on the item specified in the instructions in the event that our product is defective. The annual period begins with the acceptance of the product by the customer. A prerequisite for the assertion of the warranty is proper maintenance in accordance with the assembly instructions as well as the intended use of the item. You of course retain the statutory warranty rights within this year.

In addition, we grant you a 10-year warranty on aluminium frame parts in accordance with the following conditions:

The warranty period starts on the date of delivery, which must be evidenced by the proof of purchase, such as invoice, delivery note or copy.

Exclusion: The warranty period does not apply to natural wear and tear or transport damage, as well as to environmental damage caused by hail, wind or snow, nor to damage caused by non-compliance with the assembly instructions and non-standard installation, use of materials that are not original ones, mechanical damage, the influence of chemicals, natural disasters and other violent influences. The manufacturer is not liable for any indirect consequential and financial damage. Repair work does not renew or extend the warranty period. The manufacturer reserves the right to make decisions on the manner in which warranty claims are settled. For warranty claims, malfunctions or spare parts requirements, please contact your specialist dealer.

The roof of your cold frame attachment must be cleared of snow and ice during the winter months!

IMPORTANT INFORMATION

CHECKING PARTS LISTS

We strongly recommend checking the parts of the frame as well as the twin-wall sheets for completeness on the basis of the parts list. With the guarantee that all parts are completely available, a continuous structure is ensured and you save time and hassle of having to stop assembly.

ATTENTION:

To rule out shortfalls as far as possible, we use **the most modern weighing techniques**, and the individual packing steps are continuously and fully monitored by **exact weight checks**. This allows us to largely rule out any shortages or any mixing up of parts.

However, if a part is damaged during transport, or if a part is missing, we will send it to you as quickly as possible.

IN EVENT OF QUESTIONS, CONTACT THE SELLER:

The manufacturer / importer is GFP Handels GesmbH, Passauerstr. 24, A-4070 Eferding, Austria (hereinafter also referred to as “the manufacturer“, “we“ or “us“).

If you have any questions about the assembly or the product itself, please contact the supplier through whom you purchased your product.

RETURNS POLICY FOR TWIN-WALL SHEETS

Sometimes when stapling the wall sheet cartons, **sheets** can be **slightly damaged at the side ends** by the stapler.







Please note that **twin-wall sheets normally do not have closed side edges** and this is a unique feature we offer.









Therefore, **minor damage** (any damage no longer visible either after insertion into aluminium profiles or after attachment of the plastic clips – i.e., no longer visible **further than approx. 7 mm** into the sheet) **do not constitute grounds for complaint**, since neither the function nor the appearance is impaired as a result.

Exchanging plates of this type is **only possible after returning the original plates!**

Parts lists

Cold frame attachment, 119 x 119 cm





SKETCH	PART. NO.	DESIGNATION	LENGTH	QTY.
	101279	Top/bottom profile	1102 mm	8
	101300	Corner profile	196 mm	4
	101230	Window hinge	574 mm	8
	101307	Window frame profile	533 mm	8
	101335	Centre ridge/support profile	521 mm	2
	101356	Centre ridge/support profile	1102 mm	1

SKETCH	PART. NO.	DESIGNATION	LENGTH	QTY.
	200101	Corner connector		8
	200111	Edge protection - window		6
	200121	Cap		4
	200131	Stay		4
	200141	Window stay latch		4
	200151	Bracket		12
	200161	Fastening clip		8
	200171	Slide guard		4









Twin-wall sheets









		Twin-wall sheet, wall	160 x 1125 mm	4
		Twin-wall sheet, window	543 x 549 mm	4

Screws

	690509	M6x12 screw		56
	690510	Flat-head screw, M6x16		8
	690547	M6 nut		64
	664753	Tapping screw, 4.2x22 (window)		16
	9040556	Drilling screw, 4.8x13 mm		16

Cold frame attachment, 119 x 150 cm





SKETCH	PART. NO.	DESIGNATION	LENGTH	QTY.
	101279	Top/bottom profile	1102 mm	4
	101286	Top/bottom profile	1415 mm	4
	101300	Corner profile	196 mm	4
	101230	Window hinge	574 mm	8
	101314	Window frame profile	690 mm	8
	101342	Centre ridge/support profile	677 mm	2
	101356	Centre ridge/support profile	1102 mm	1
	101195	Centre profile	137 mm	2

SKETCH	PART. NO.	DESIGNATION	LENGTH	QTY.
	200101	Corner connector		8
	200111	Edge protection - window		6
	200121	Cap		4
	200131	Stay		4
	200141	Window stay latch		4
	200151	Bracket		12
	200161	Fastening clip		8
	200171	Slide guard		4









Twin-wall sheets

		Twin-wall sheet, wall	160 x 1125 mm	2
		Twin-wall sheet, wall	160 x 700 mm	4
		Twin-wall sheet, window	543 x 705 mm	4

Screws

	690509	M6x12 screw		56
	690510	Flat-head screw, M6x16		8
	690547	M6 nut		64
	664753	Tapping screw, 4.2x22 (window)		16
	9040556	Drilling screw, 4.8x13 mm		16







Cold frame attachment, 150 x 119 cm

SKETCH	PART. NO.	DESIGNATION	LENGTH	QTY.
	101286	Top/bottom profile	1415 mm	4
	101279	Top/bottom profile	1102 mm	4
	101300	Corner profile	196 mm	4
	101237	Window hinge	730 mm	8
	101307	Window frame profile	533 mm	8
	101335	Centre ridge/support profile	521 mm	2
	101363	Centre ridge/support profile	1415 mm	1
	101195	Centre profile	137 mm	2

Twin-wall sheets









		Twin-wall sheet, wall	160 x 700 mm	4
		Twin-wall sheet, wall	160 x 1125 mm	2
		Twin-wall sheet, window	700 x 549 mm	4

Cold frame attachment, 150 x 150 cm





SKETCH	PART. NO.	DESIGNATION	LENGTH	QTY.
	101286	Top/bottom profile	1415 mm	8
	101300	Corner profile	196 mm	4
	101237	Window hinge	730 mm	8
	101314	Window frame profile	690 mm	8
	101342	Centre ridge/support profile	677 mm	2
	101363	Centre ridge/support profile	1415 mm	1
	101195	Centre profile	137 mm	4









Twin-wall sheets

		Twin-wall sheet, wall	160 x 700 mm	8
		Twin-wall sheet, window	700 x 705 mm	4





SKETCH	PART. NO.	DESIGNATION	LENGTH	QTY.
	200101	Corner connector		8
	200111	Edge protection - window		6
	200121	Cap		4
	200131	Stay		4
	200141	Window stay latch		4
	200151	Bracket		12
	200161	Fastening clip		8
	200171	Slide guard		4

Screws

	690509	M6x12 screw		56
	690510	Flat-head screw, M6x16		8
	690547	M6 nut		64
	664753	Tapping screw, 4.2x22 (window)		16
	9040556	Drilling screw, 4.8x13 mm		16

SKETCH	PART. NO.	DESIGNATION	LENGTH	QTY.
	200101	Corner connector		8
	200111	Edge protection - window		6
	200121	Cap		4
	200131	Stay		4
	200141	Window stay latch		4
	200151	Bracket		12
	200161	Fastening clip		8
	200171	Slide guard		4

Screws

	690509	M6x12 screw		56
	690510	Flat-head screw, M6x16		8
	690547	M6 nut		64
	664753	Tapping screw, 4.2x22 (window)		16
	9040556	Drilling screw, 4.8x13 mm		16

Parts lists

Cold frame attachment, 195 x 119 cm

SKETCH	PART. NO.	DESIGNATION	LENGTH	QTY.
	101279	Top/bottom profile	1102 mm	4
	101293	Top/bottom profile	1865 mm	4
	101300	Corner profile	196 mm	4
	101244	Window hinge	955 mm	8
	101307	Window frame profile	533 mm	8
	101335	Centre ridge/support profile	521 mm	2
	101370	Centre ridge/support profile	1865 mm	1
	101195	Centre profile	137 mm	2
	101202	Glazing bar	533 mm	4

Twin-wall sheets









		Twin-wall sheet, wall	160 x 925mm	4
		Twin-wall sheet, wall	160 x 1125 mm	2
		Twin-wall sheet, window	447 x 549 mm	8

Cold frame attachment, 195 x 150 cm





SKETCH	PART. NO.	DESIGNATION	LENGTH	QTY.
	101286	Top/bottom profile	1415 mm	4
	101293	Top/bottom profile	1865 mm	4
	101300	Corner profile	196 mm	4
	101244	Window hinge	955 mm	8
	101314	Window frame profile	690 mm	8
	101342	Centre ridge/support profile	677 mm	2
	101370	Centre ridge/support profile	1865 mm	1
	101195	Centre profile	137 mm	4
	101209	Glazing bar	690 mm	4









Twin-wall sheets

		Twin-wall sheet, wall	160 x 925mm	4
		Twin-wall sheet, wall	160 x 700 mm	4
		Twin-wall sheet, window	447 x 705 mm	8





SKETCH	PART. NO.	DESIGNATION	LENGTH	QTY.
	200101	Corner connector		8
	200111	Edge protection - window		6
	200121	Cap		4
	200131	Stay		4
	200141	Window stay latch		4
	200151	Bracket		12
	200161	Fastening clip		8
	200171	Slide guard		4

Screws

	690509	M6x12 screw		56
	690510	Flat-head screw, M6x16		8
	690547	M6 nut		64
	664753	Tapping screw, 4.2x22 (window)		24
	9040556	Drilling screw, 4.8x13 mm		16

SKETCH	PART. NO.	DESIGNATION	LENGTH	QTY.
	200101	Corner connector		8
	200111	Edge protection - window		6
	200121	Cap		4
	200131	Stay		4
	200141	Window stay latch		4
	200151	Bracket		12
	200161	Fastening clip		8
	200171	Slide guard		4

Screws

	690509	M6x12 screw		56
	690510	Flat-head screw, M6x16		8
	690547	M6 nut		64
	664753	Tapping screw, 4.2x22 (window)		24
	9040556	Drilling screw, 4.8x13 mm		16

Step 1 - Assembling the base frame

STEP 1 - Assembling the base frame

In the first step, the base frame is made from the two longitudinal and cross profiles "top/bottom profile".

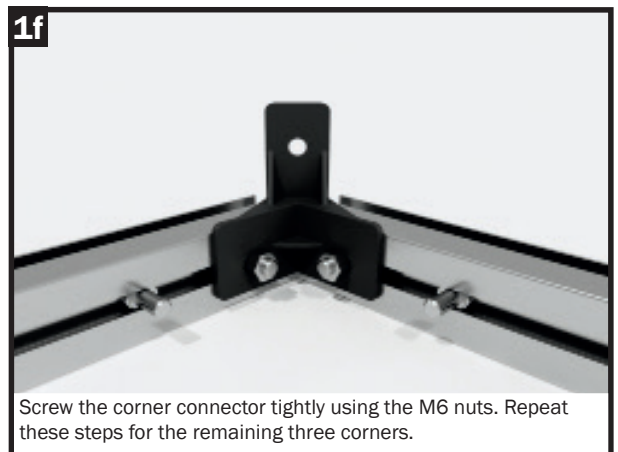
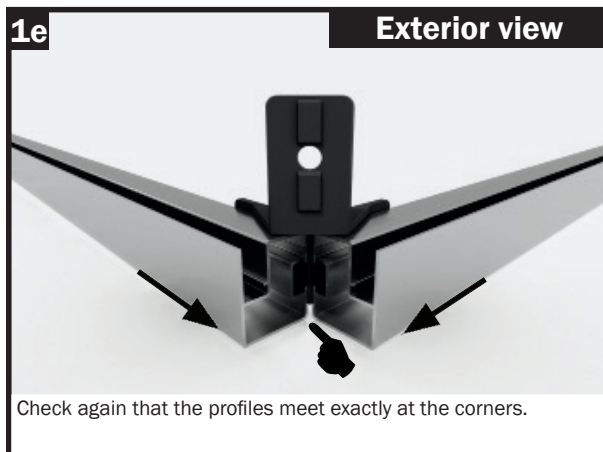
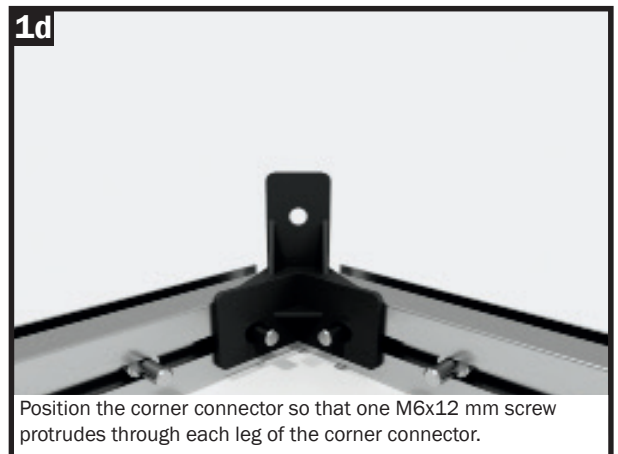
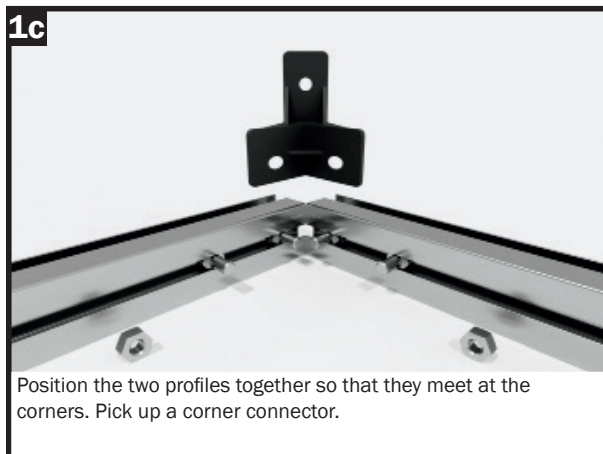
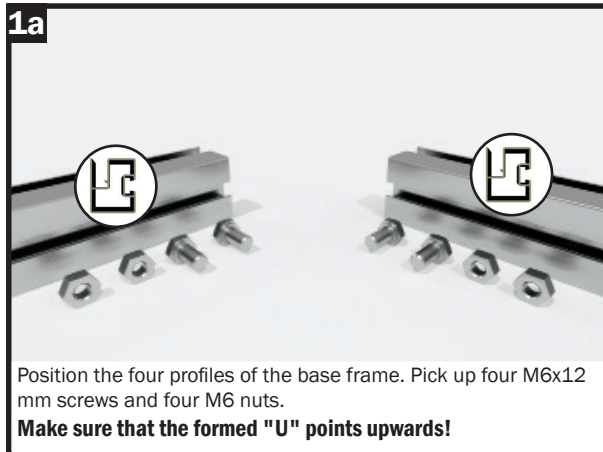
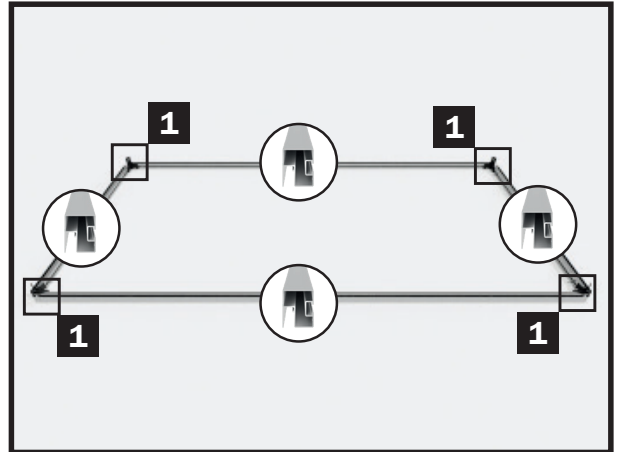

Step 2 – Assembling the corner posts

STEP 2 – Assembling the corner posts

In the second assembly step, the corner profiles are fitted at the four corners.

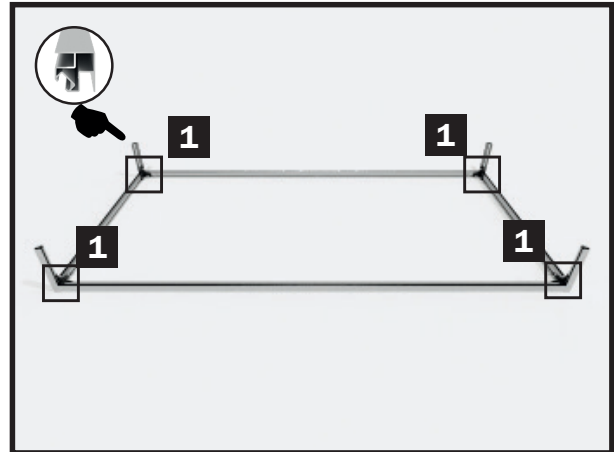

1a

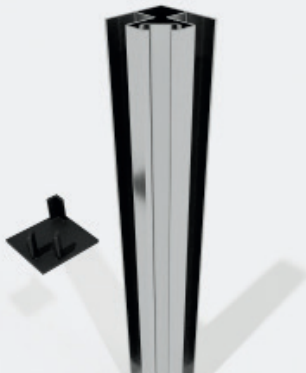

Pick up a corner profile and the plastic covering cap.

1b

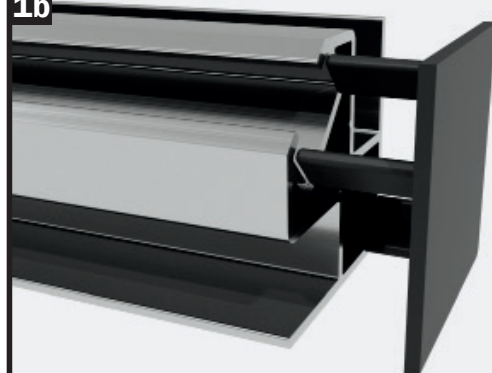

Fit the covering cap onto the corner profile.

1c

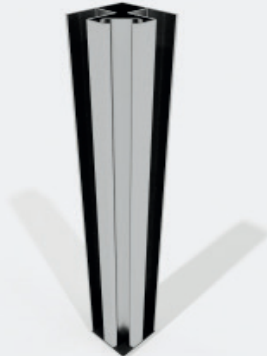

Once the covering cap is firmly pressed on, the corner profile can be mounted.

1d

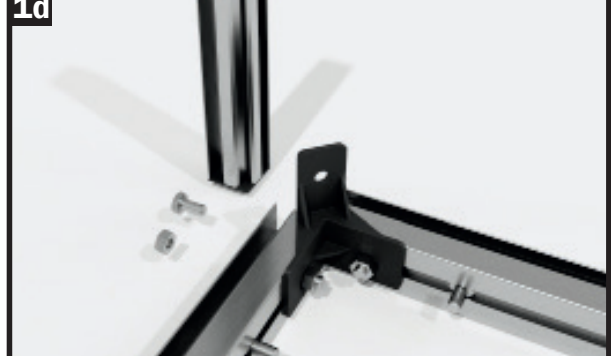

Pick up one corner profile, one M6x12 mm screw and one M6 nut.

1e



Insert the M6x12 screw into the screw channel of the corner profile.

1f



Position the corner profile so that the M6x12 mm screw protrudes through the hole in the corner connector.

Step 3 – Glazing the side walls

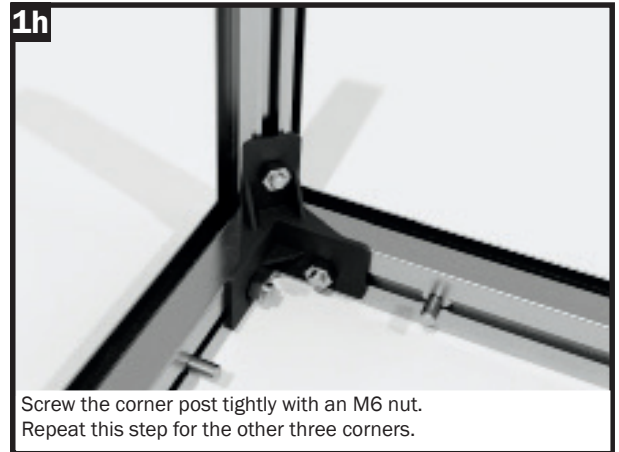
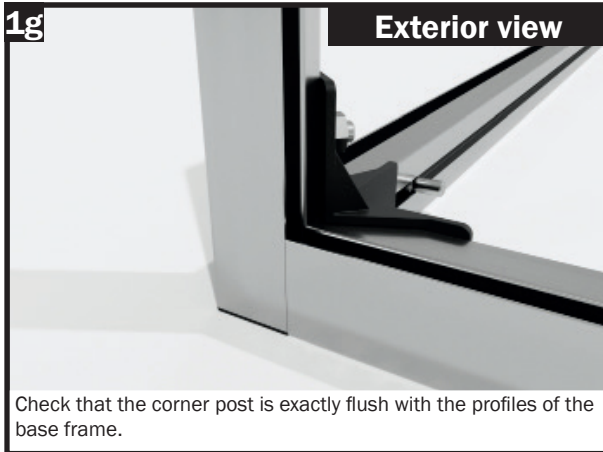

STEP 3 – Glazing the side walls

In the third assembly step, the twin-wall sheets are inserted into the side walls.

When installing the wall sheets, pay attention to the inside and outside. The outside either has lettering or a foil.

! IMPORTANT

The wall sheets (height: 160 mm) are UV-stabilised on both sides and **can therefore be installed as desired!**

NOTE

Where the length of a wall is 119 cm or more, the twin-wall sheets are divided and are connected centrally to a coupling profile.

You can therefore leave out the following assembly steps 2a and 2b for shorter sheets.

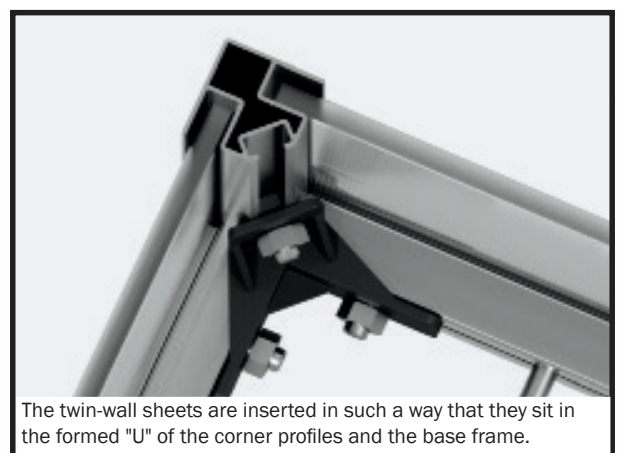
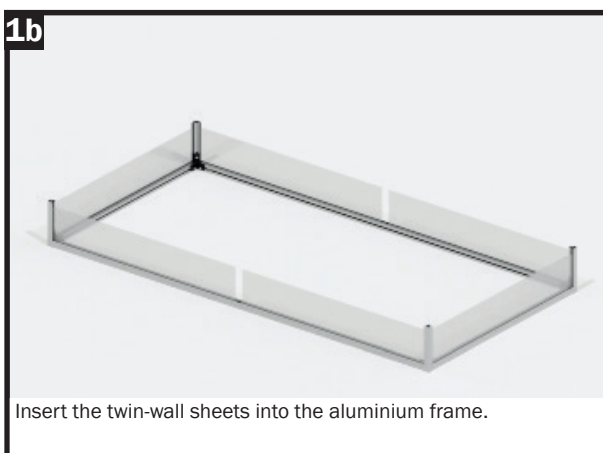
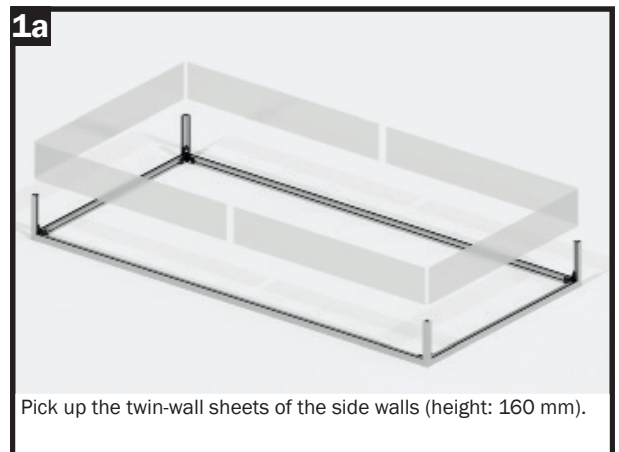
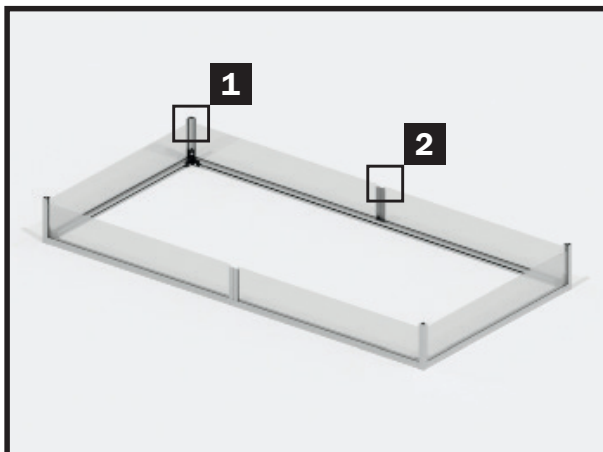

Step 4 - Attaching the top wall profiles

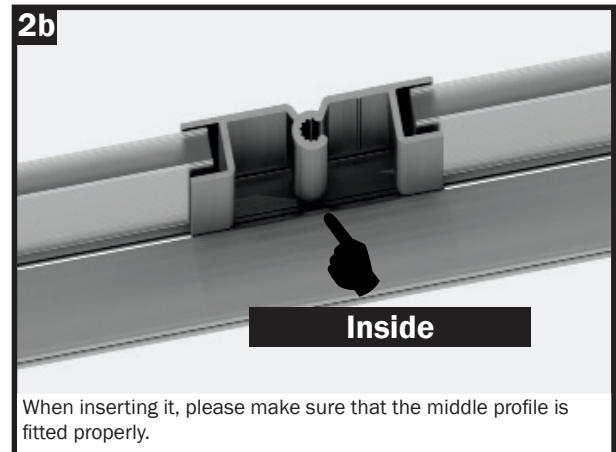
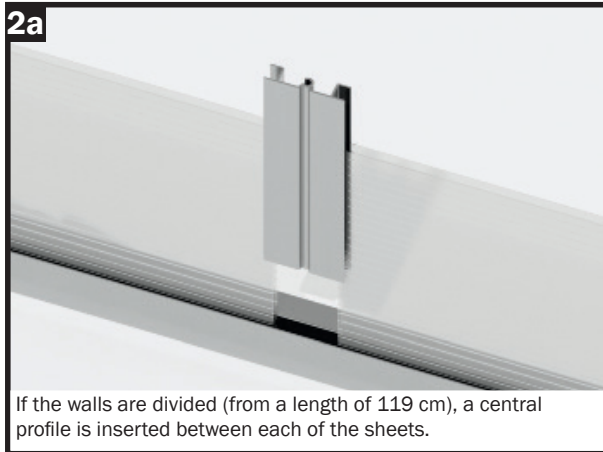

STEP 4 - Attaching the top wall profiles

In the fourth assembly step, the top profiles of the cold frame attachment are attached.

NOTE:

A support profile is later attached to the top profiles.

Please note that for the top profile, two M6x12 mm screws are inserted at each end.

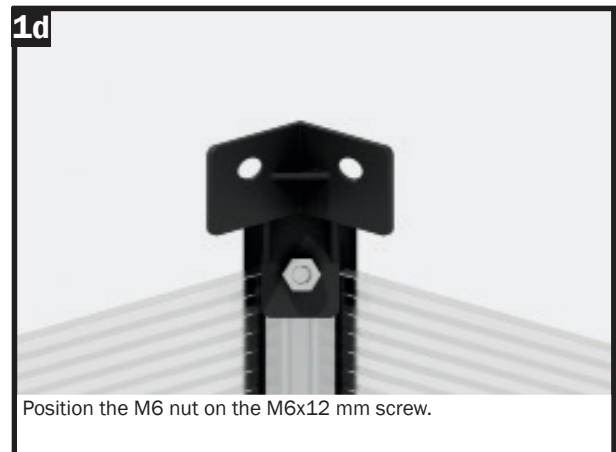
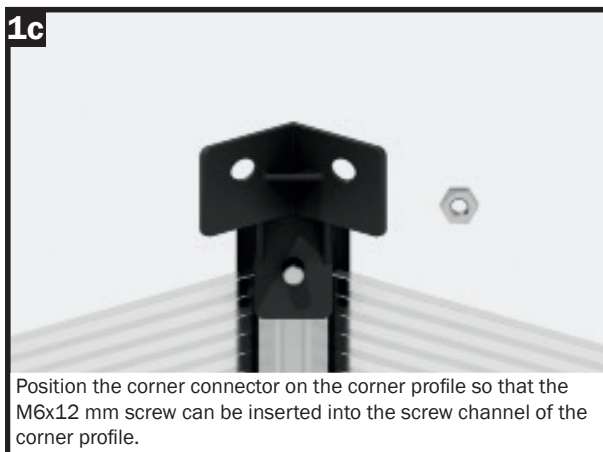
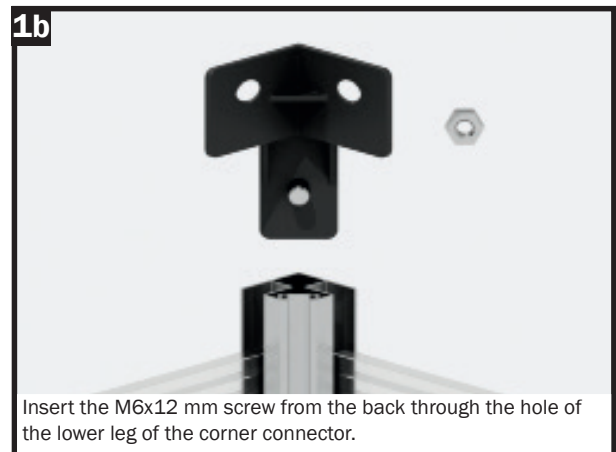
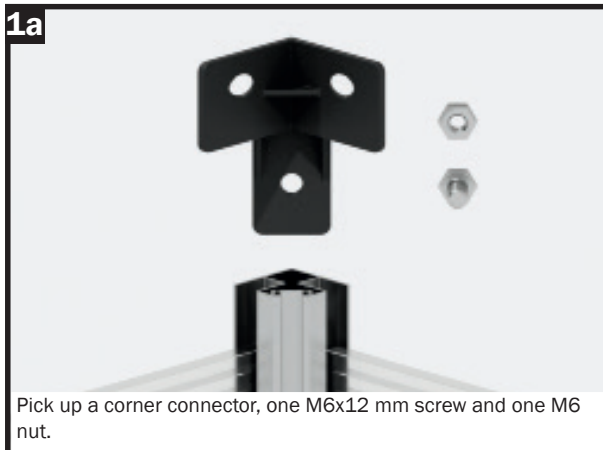
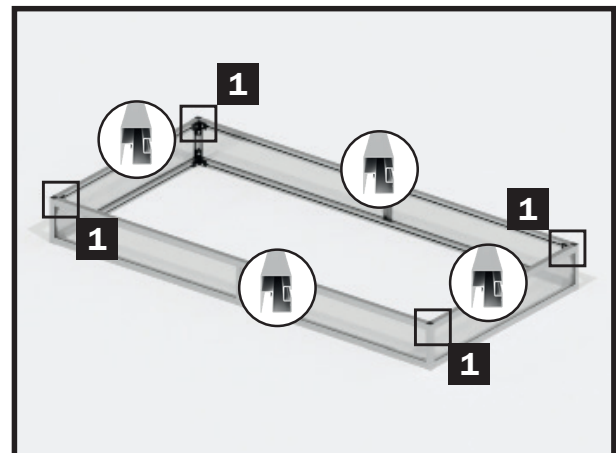

Step 4 – Attaching the top wall profiles

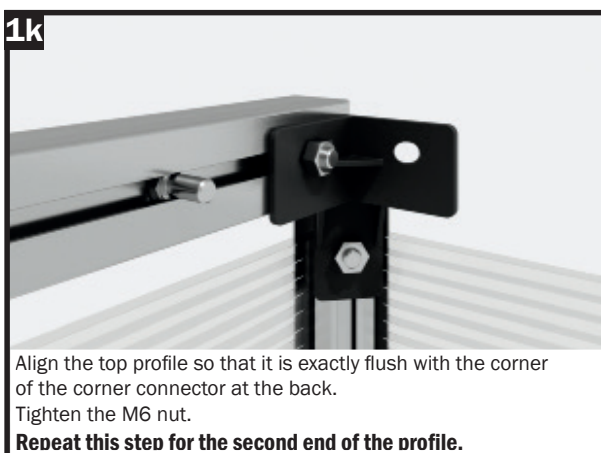
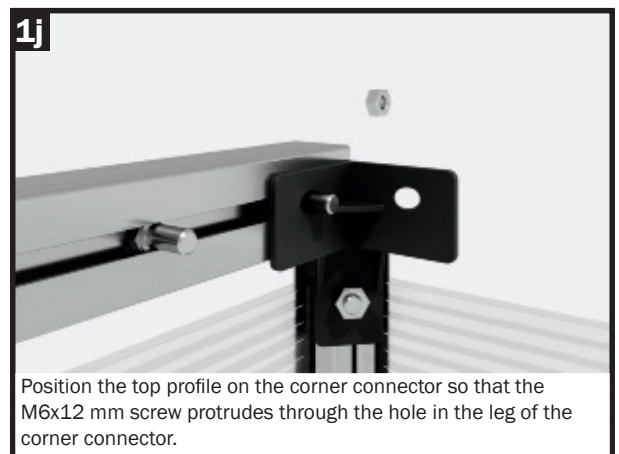
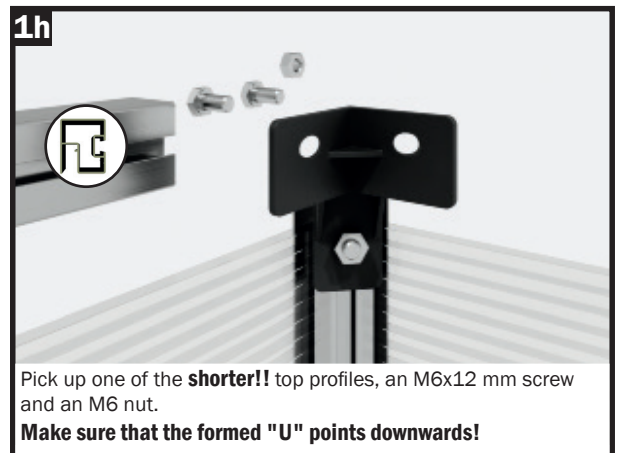
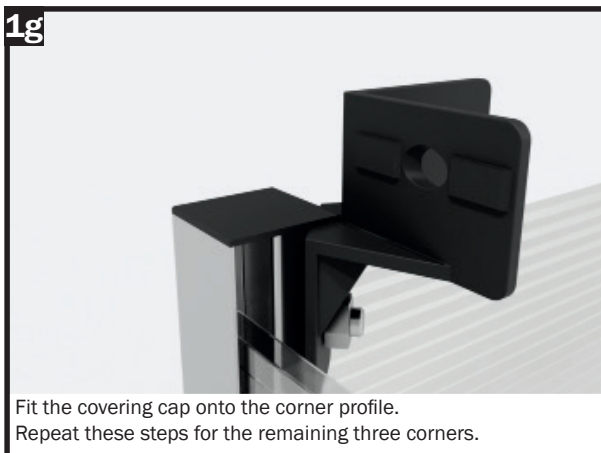
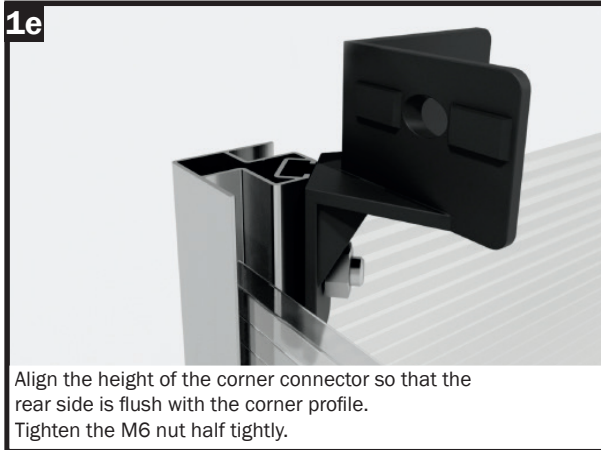

Step 4 – Attaching the top wall profiles

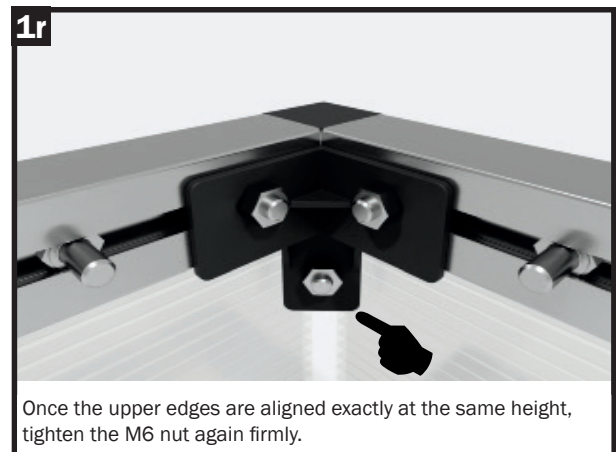
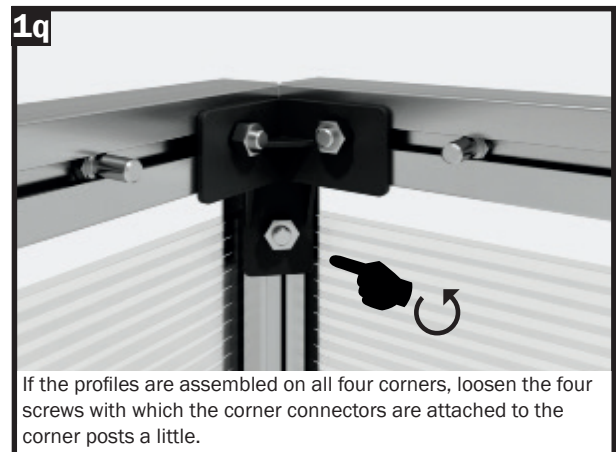
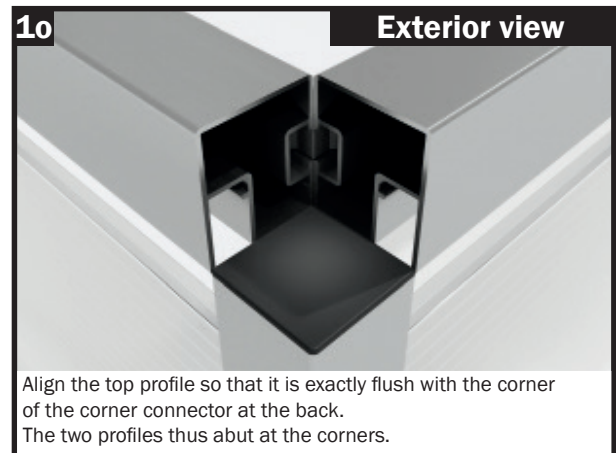
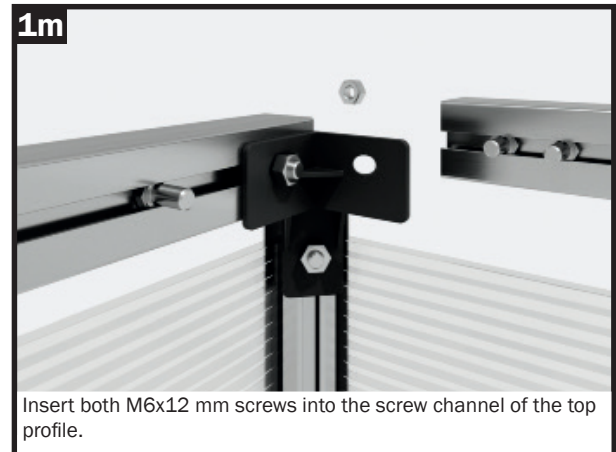
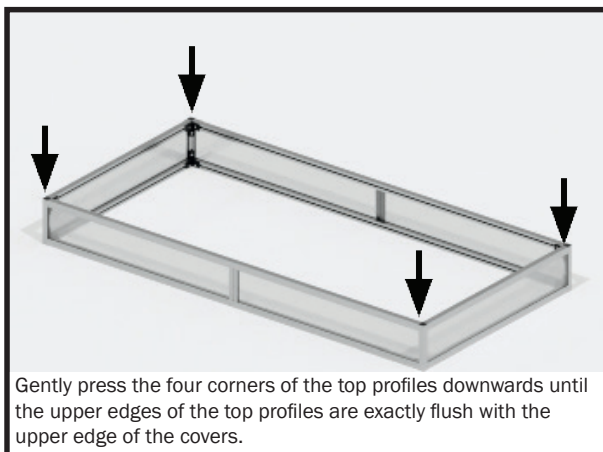
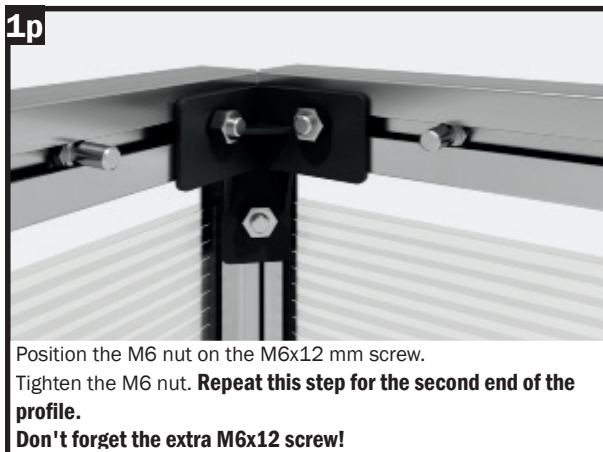
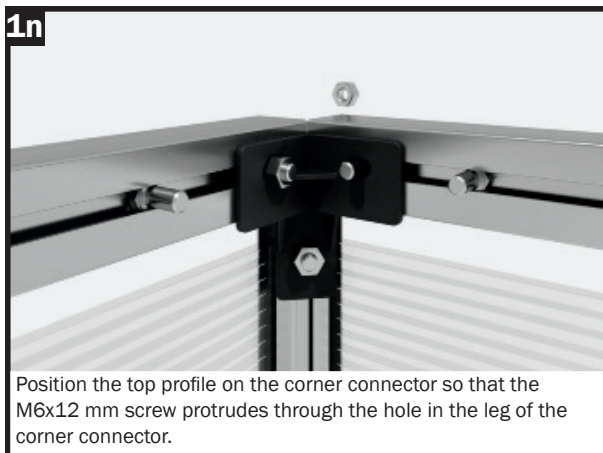
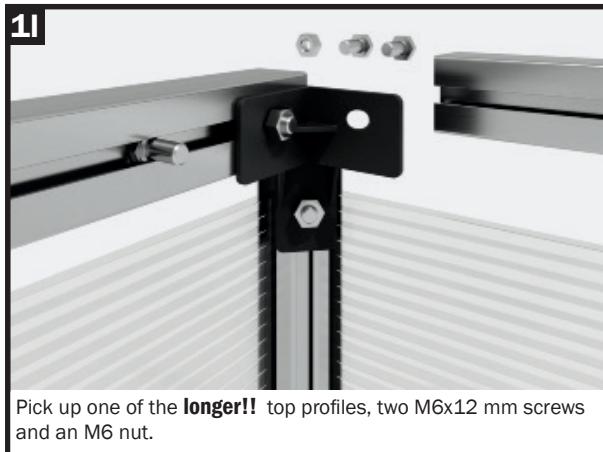

Step 5 – Assembling the middle ridge and the window support profiles

STEP 5 – Assembling the middle ridge

In the fifth assembly step, the middle ridge is attached to the broadside of the cold frame.

! IMPORTANT

It is important that assembly work is carried out exactly in the middle!

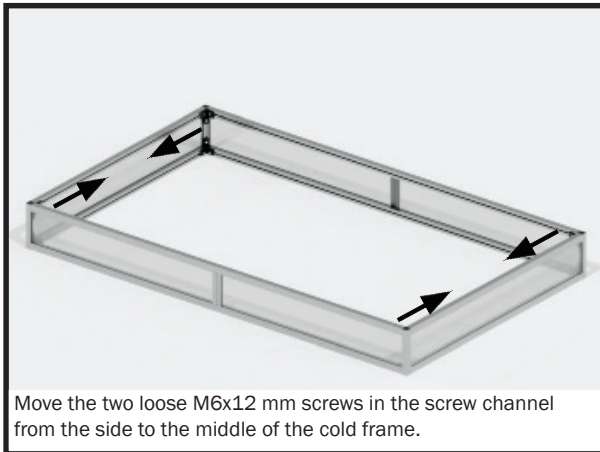
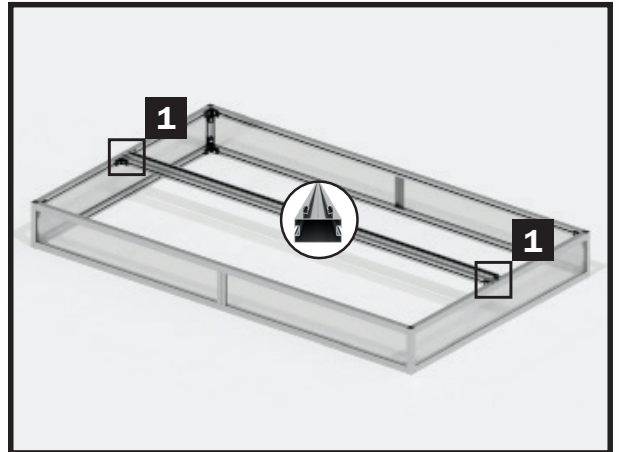

Move the two loose M6x12 mm screws in the screw channel from the side to the middle of the cold frame.

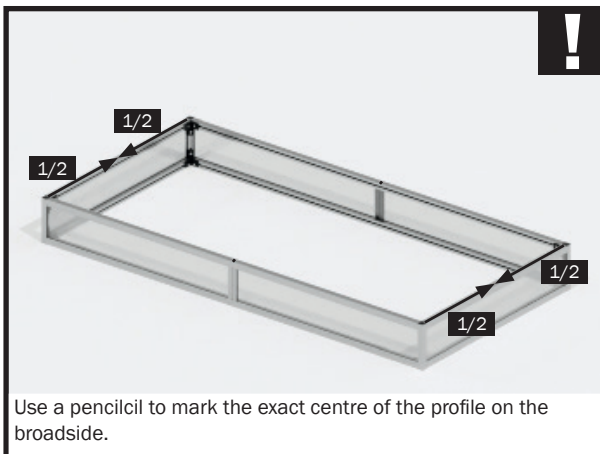
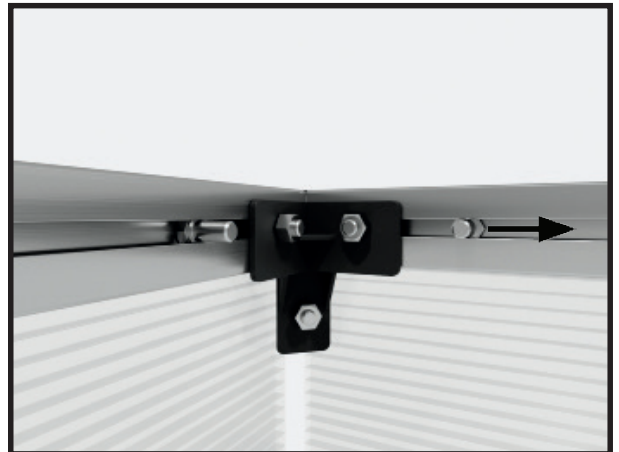

Use a pencil to mark the exact centre of the profile on the broadside.

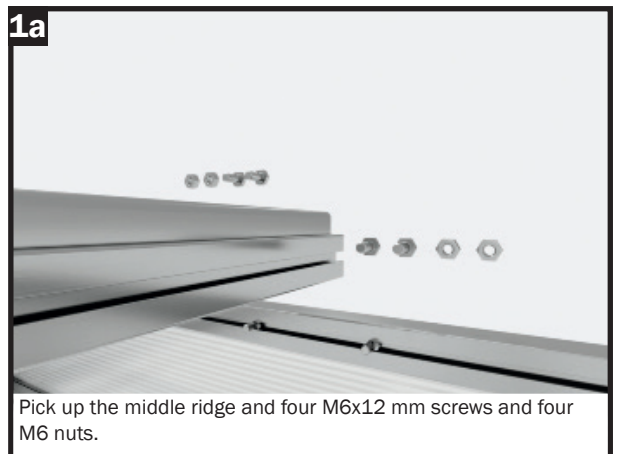

Pick up the middle ridge and four M6x12 mm screws and four M6 nuts.

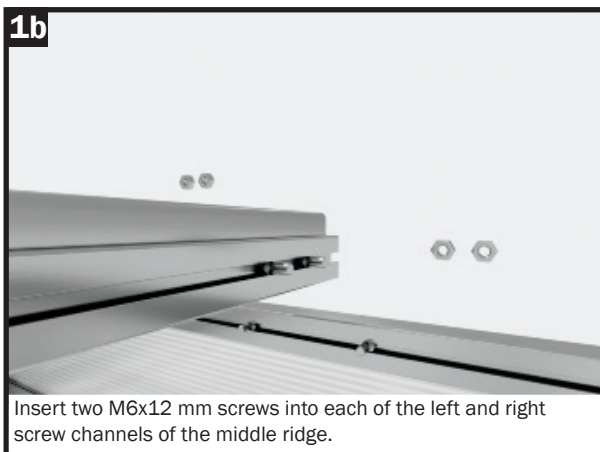

Insert two M6x12 mm screws into each of the left and right screw channels of the middle ridge.

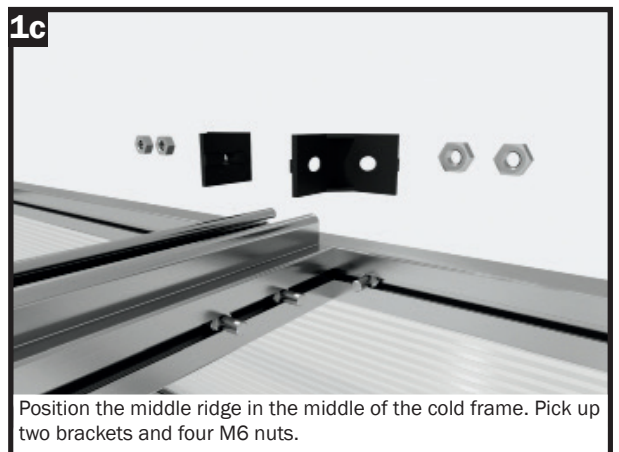

Position the middle ridge in the middle of the cold frame. Pick up two brackets and four M6 nuts.

Step 5 – Assembling the middle ridge and the window support profiles

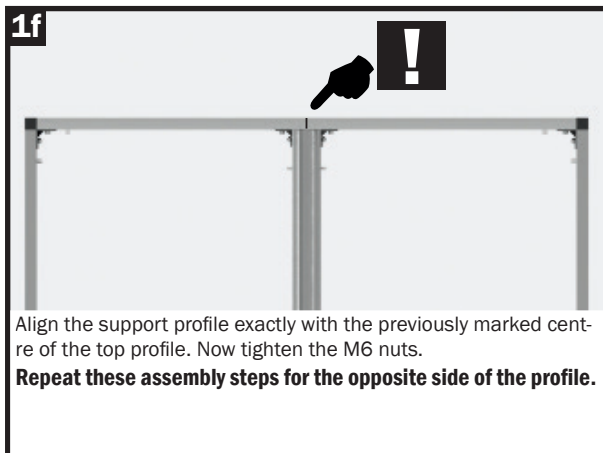
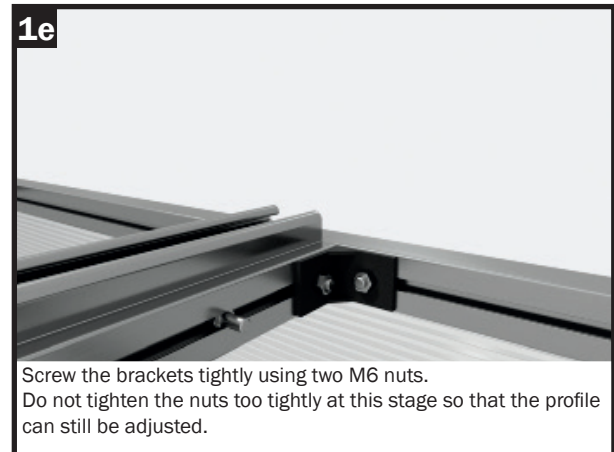
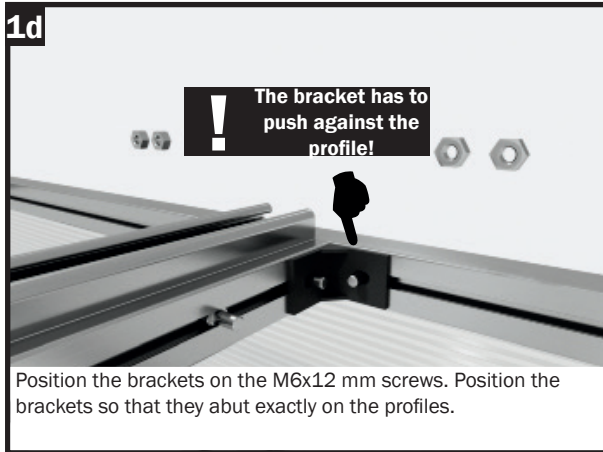

Assembling the window support profiles

In the fifth assembly step, the window support profiles are attached to the cold frame.

!IMPORTANT

It is important that assembly work is carried out exactly in the middle!

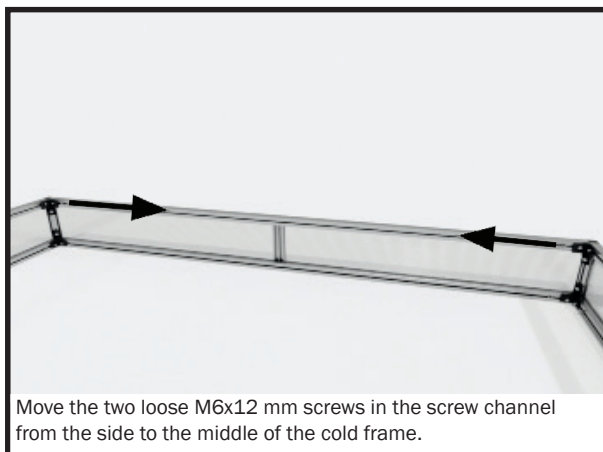
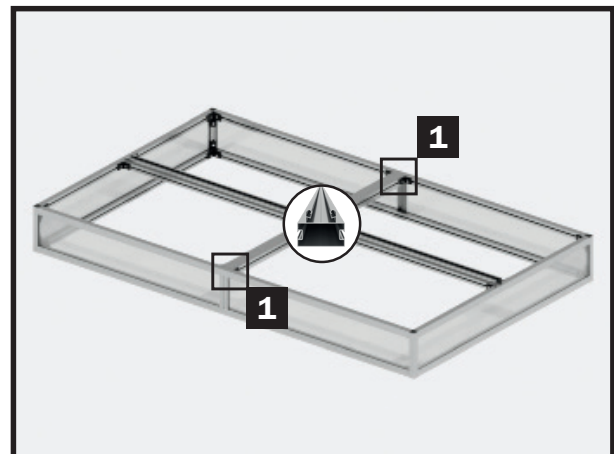

Step 5 – Assembling the middle ridge and the window support profiles

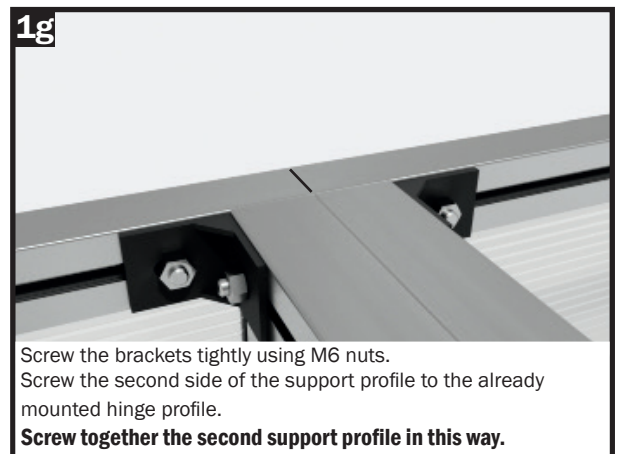
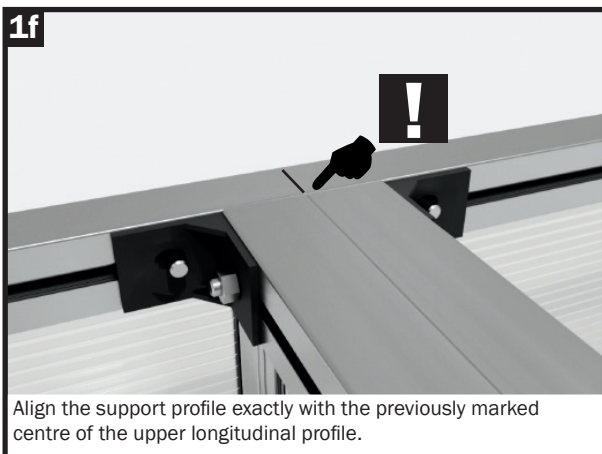
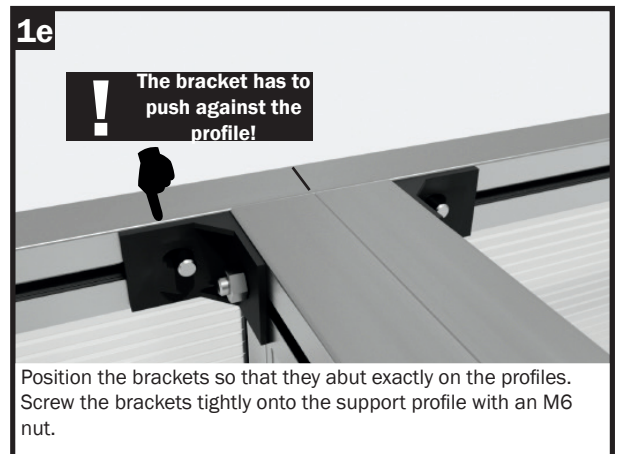
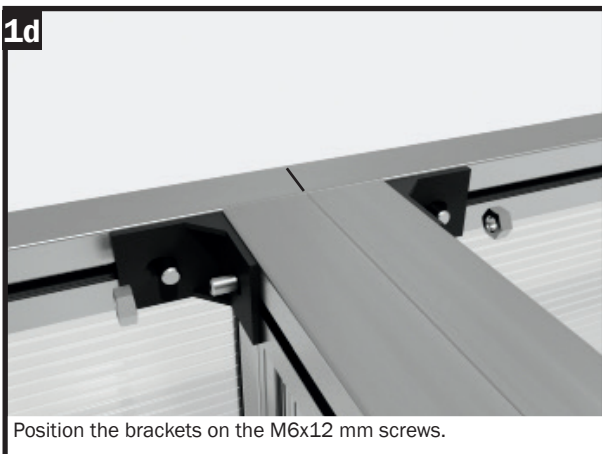
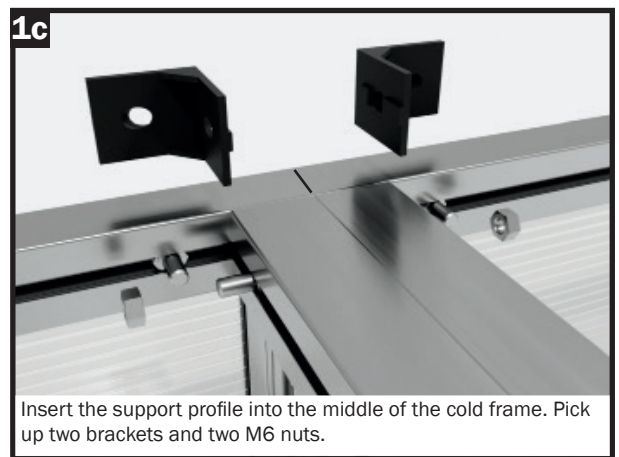
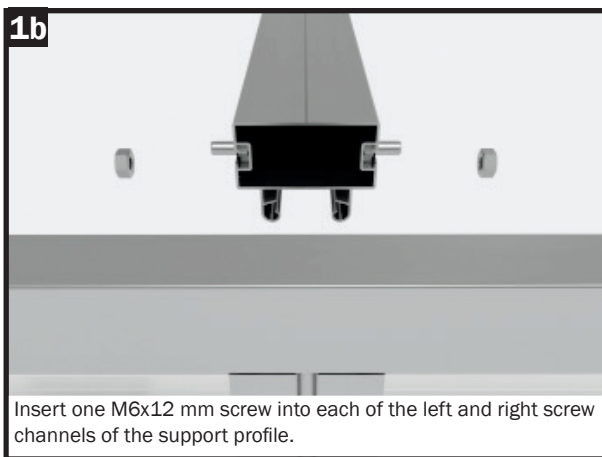
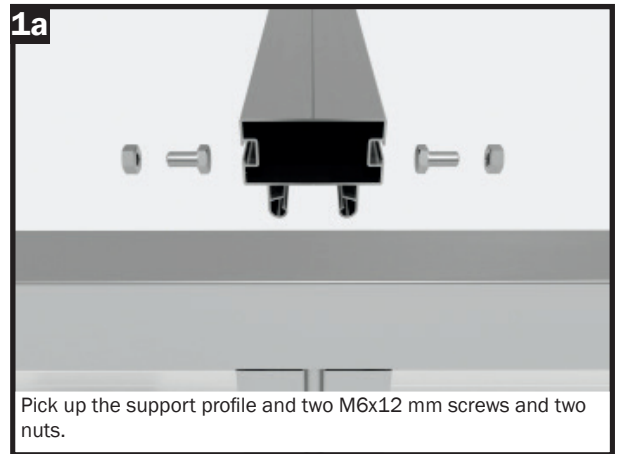
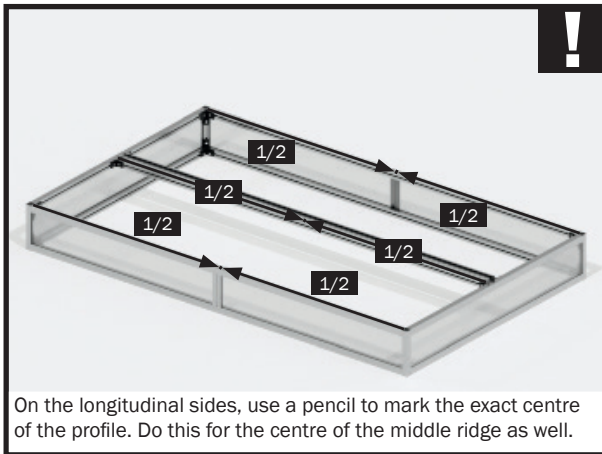

Step 6 – Assembling and installing the windows

STEP 6 – Assembling and installing the windows

In the sixth assembly step, the windows are assembled and glazed.
The windows are then inserted.

NOTE

For cold frames with a length of 195 cm, a glazing bar is inserted into the window. The assembly is shown in Figure 2.

These steps are not required for models with a length of 119 cm and 150 cm!

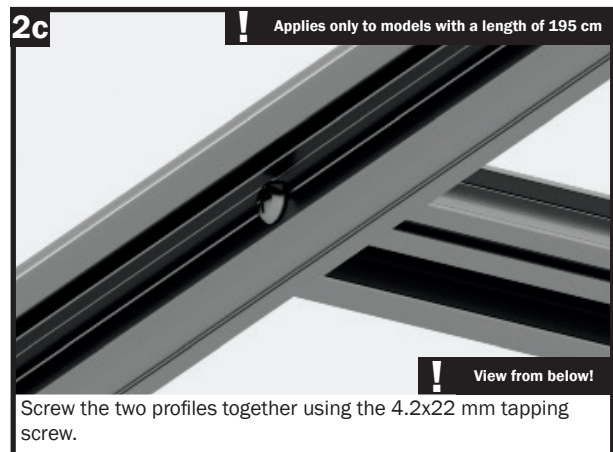
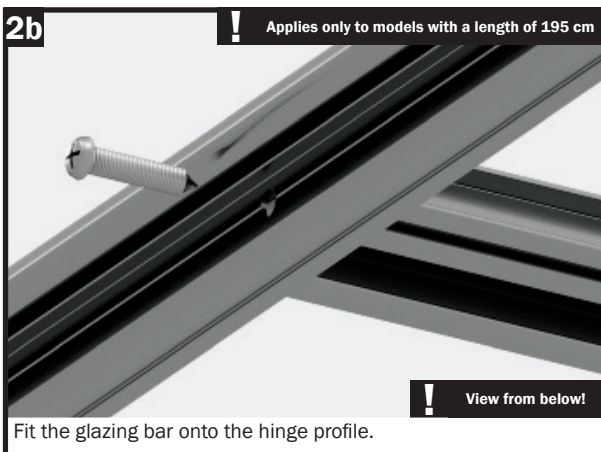
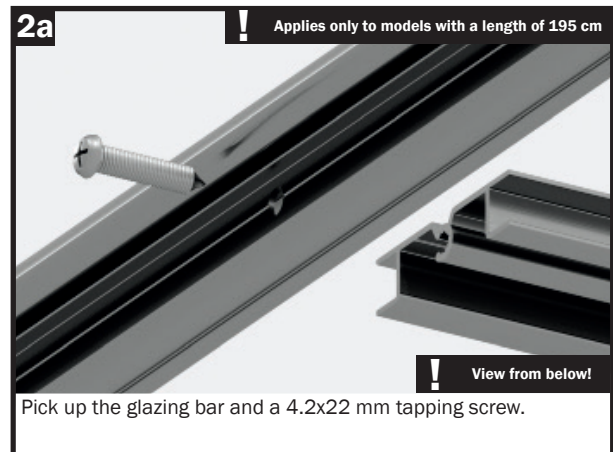
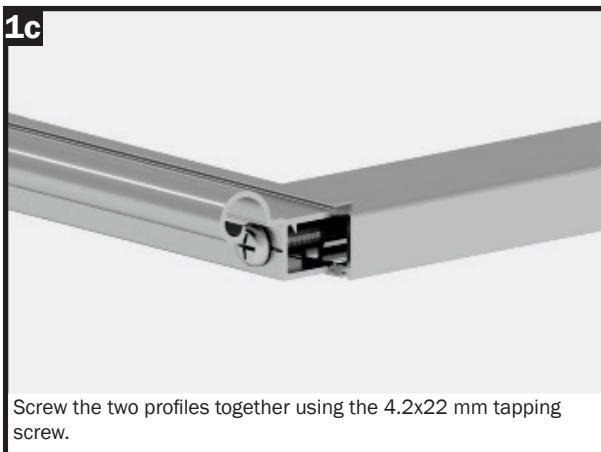
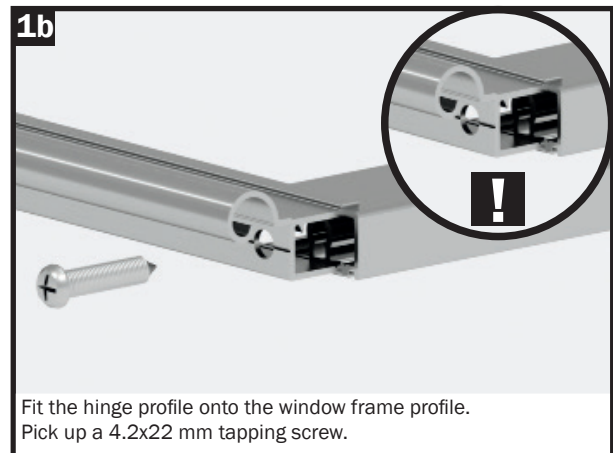
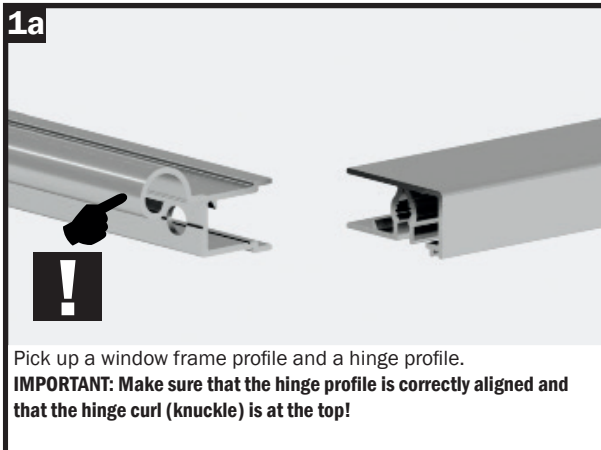
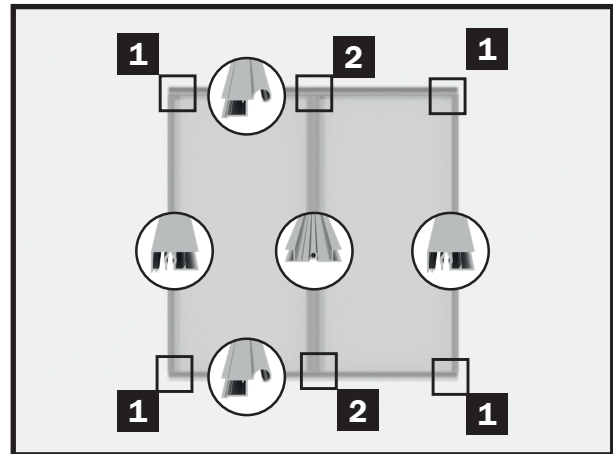

Step 6 – Assembling and installing the windows

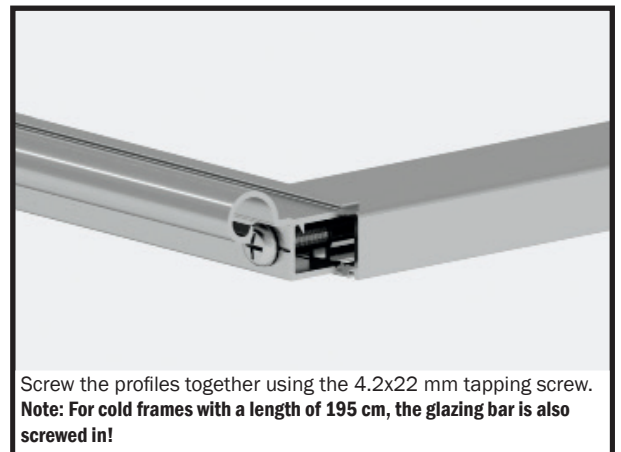
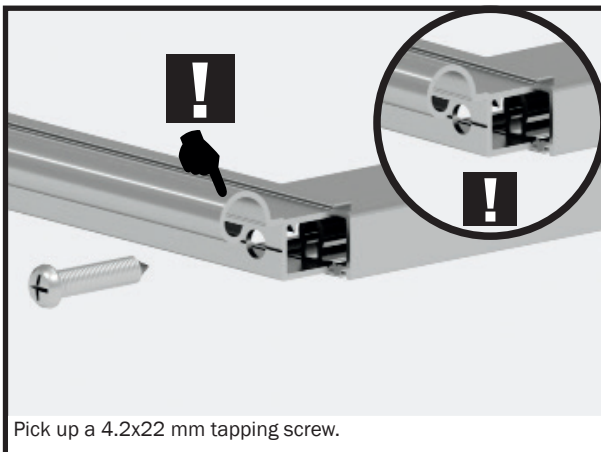
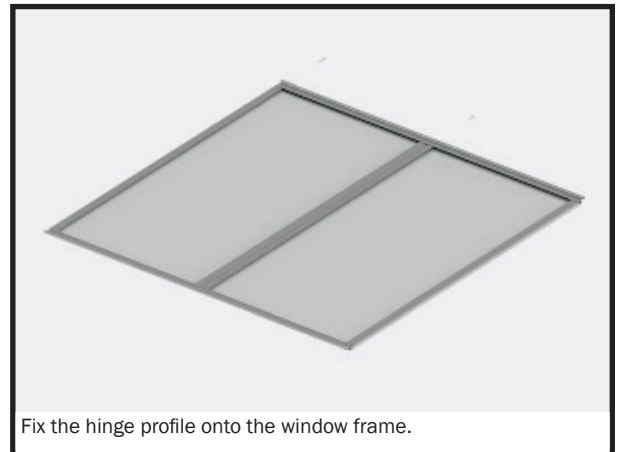
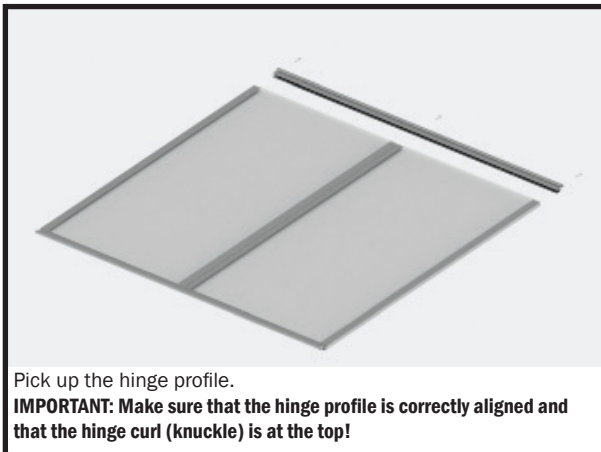
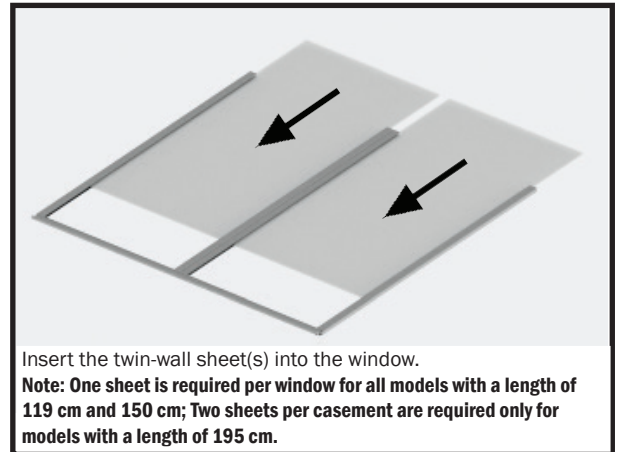
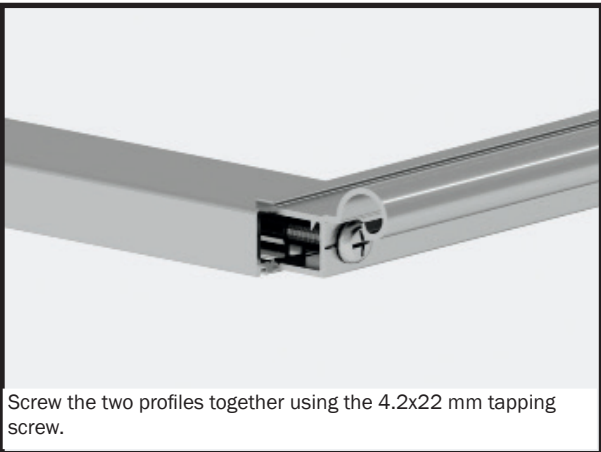
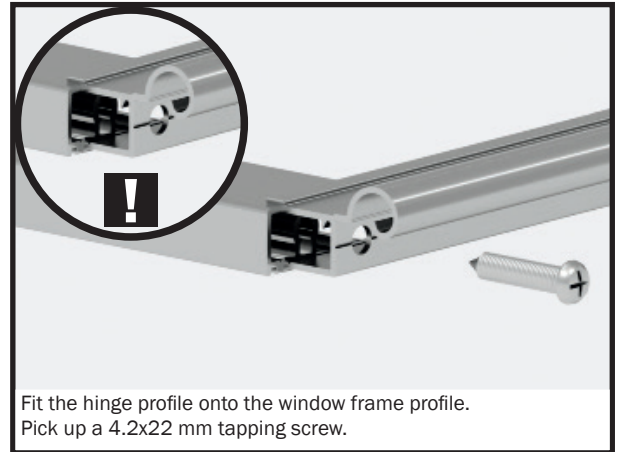
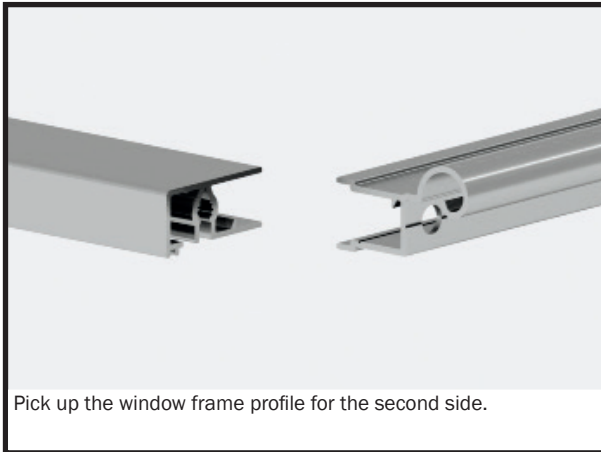

Step 6 – Assembling and installing the windows

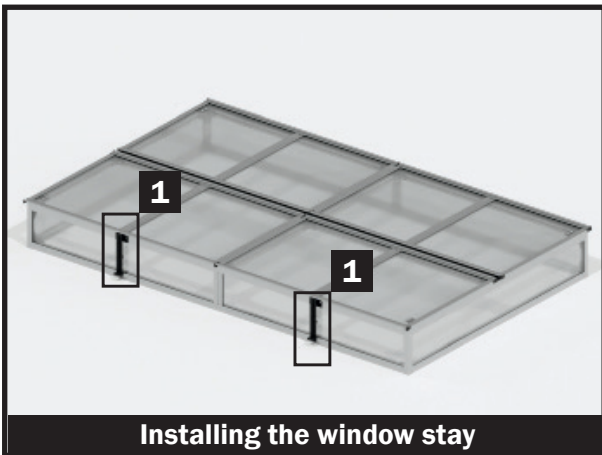
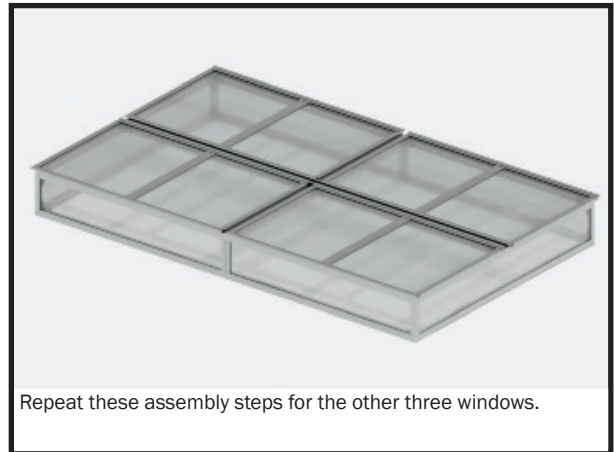
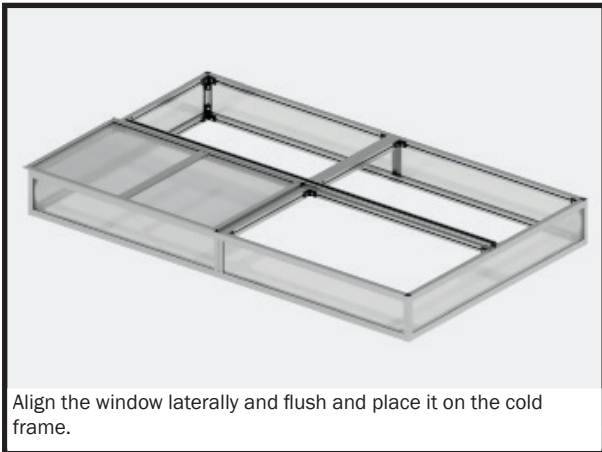
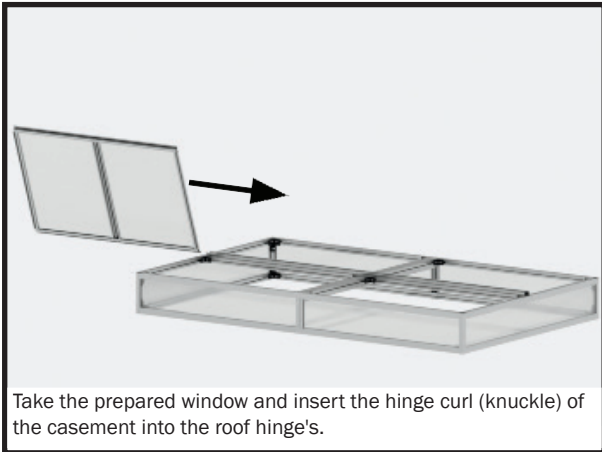

Step 6 – Assembling and installing the windows

Installing the edge protector.

Next, the edge protector is applied to the windows.

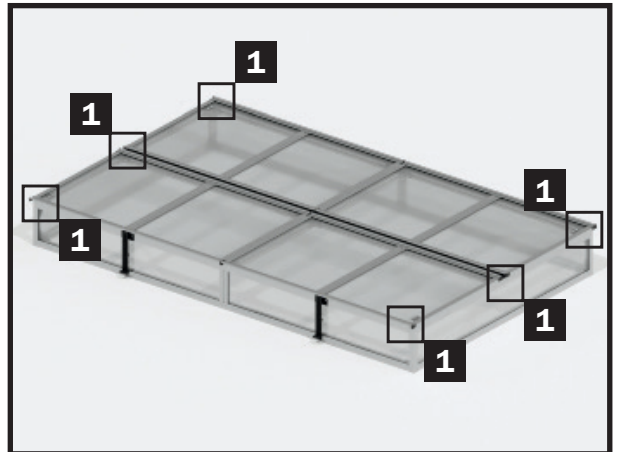

Pick up the edge protector.

Note that there are both left and right parts!

Insert the edge protector into the hinge profile of the window on the front of the cold frame.

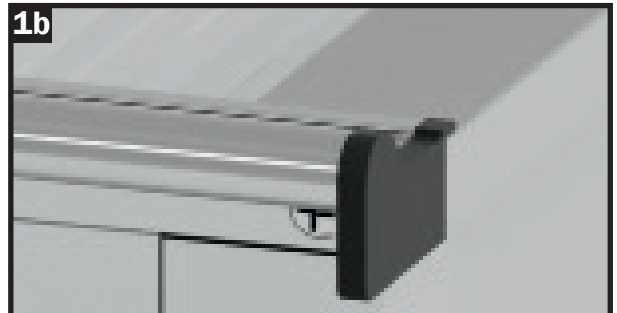

Press the edge protector in very firmly!

Repeat this for the second side of the window.

Complete this in the same way for all four windows.

The edge protector is only applied to the outside of the central profile!

Installing the window latch

In this assembly step, the window latches are attached to the cold frame.

When in use, the window stay is clipped onto the window latch so that the window remains open.

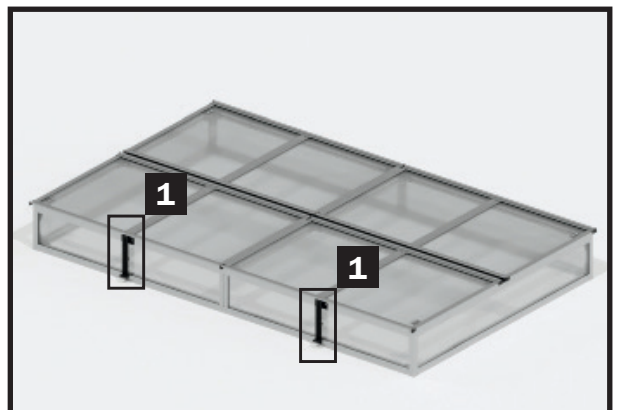

Attaching the window latches



Pick up the window stay latch and two 4.8x13 mm self-drilling tapping screws.



Mark the exact centre of the window and fit the window latch.

Step 6 – Assembling and installing the windows

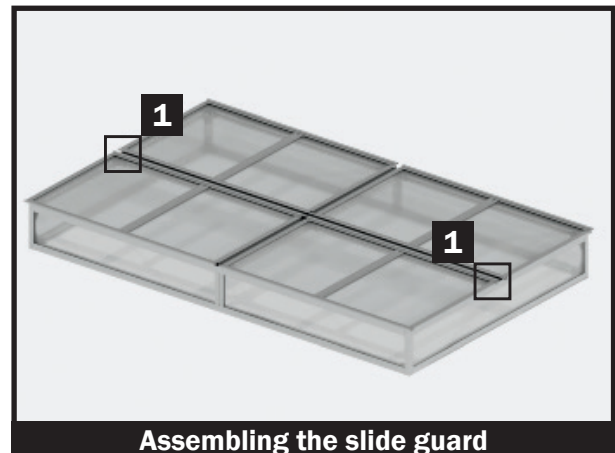
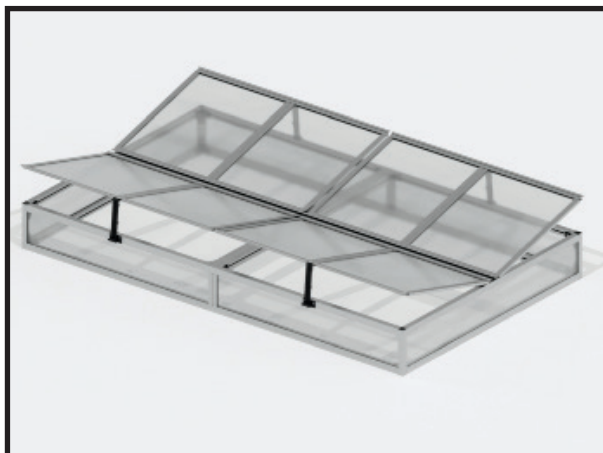

The slide guard prevents the window from sliding outwards in an uncontrolled manner when using the cold frame on a day-to-day basis.

NOTE:

The slide guard is screwed directly onto the twin-wall sheet.

To do this, drill two 7 mm holes through the twin-wall sheet on the windows.

The dimensions can be found in the sketch on the side.

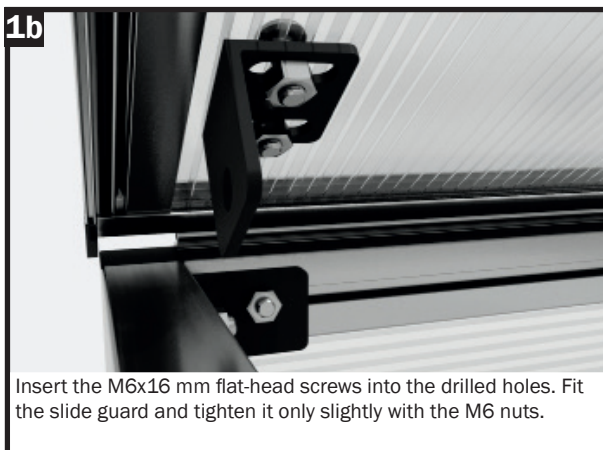
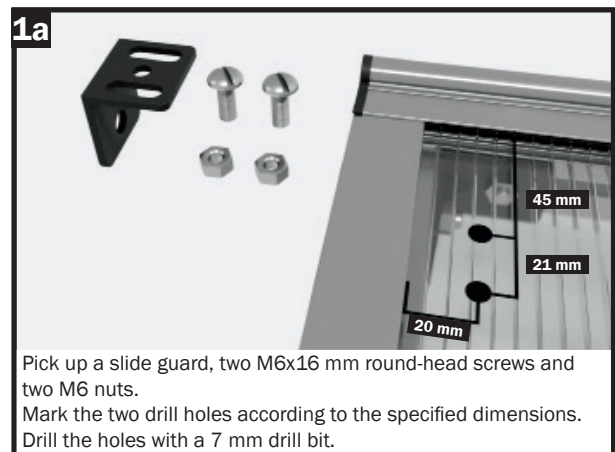

! NOTE

The slide guard is provided with oblong holes so that it can be optimally adjusted.

Simply press the window gently towards the centre until it touches the edge protector.

Then adjust the slide guard and carefully tighten the screws.

Step 6 – Assembling and installing the windows

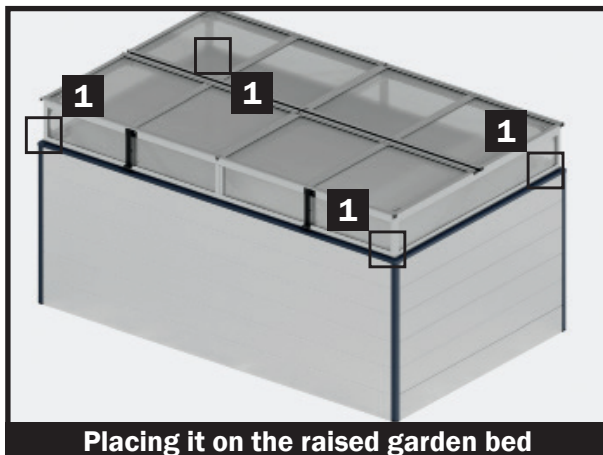
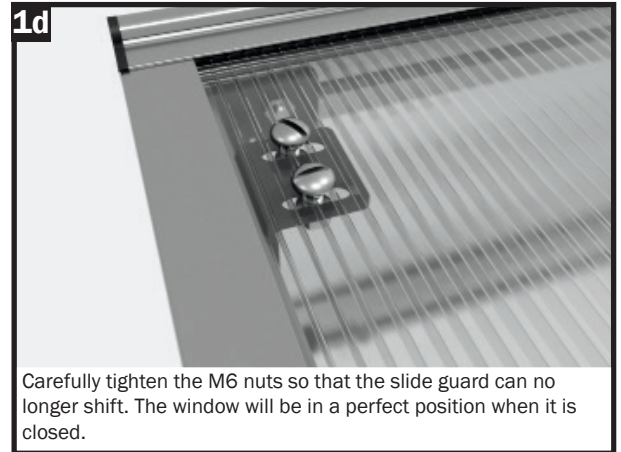

PLACING THE COLD FRAME ON THE RAISED GARDEN BED

The cold frame is now placed on the raised garden bed and screwed twice to the fastening clips at each of the four corners.

! NOTE:
If you have opted for a raised garden bed without snail protection, the inner edge of the cold frame protrudes about 5 mm into the raised garden bed.

