 **GG-L1-Q1 4 m x 4 m**



07/2024-09

**TOOLPORT**



 **GG-L1-Q1 4 m x 4 m**

**A**

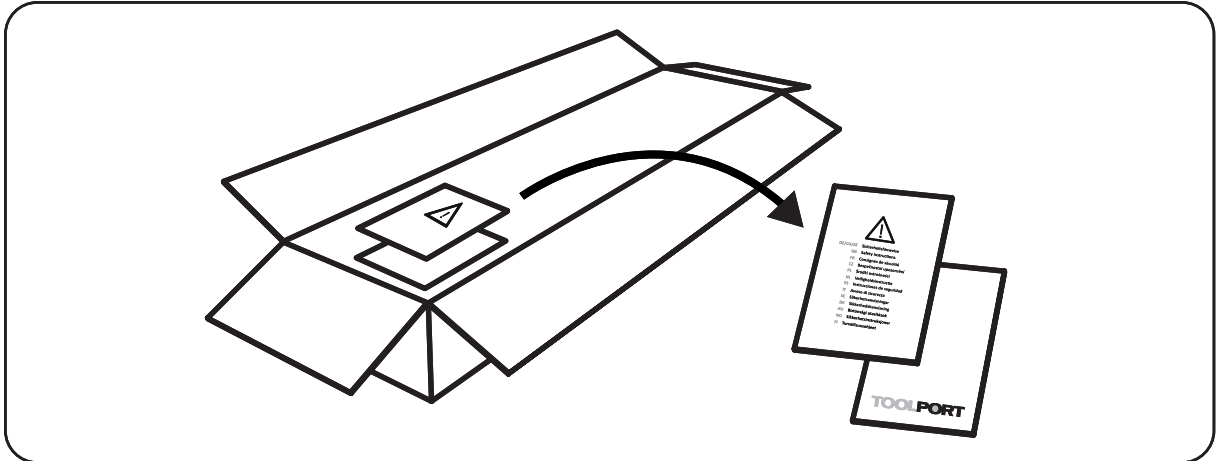



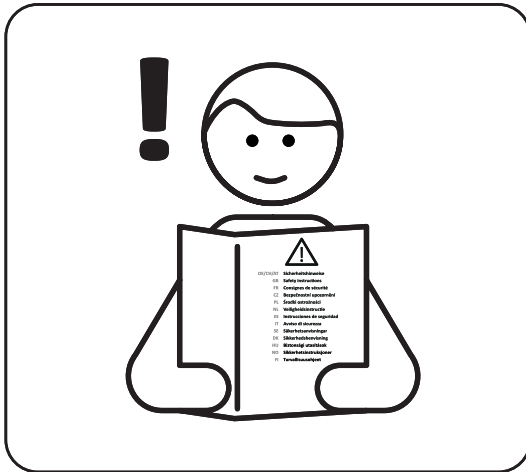



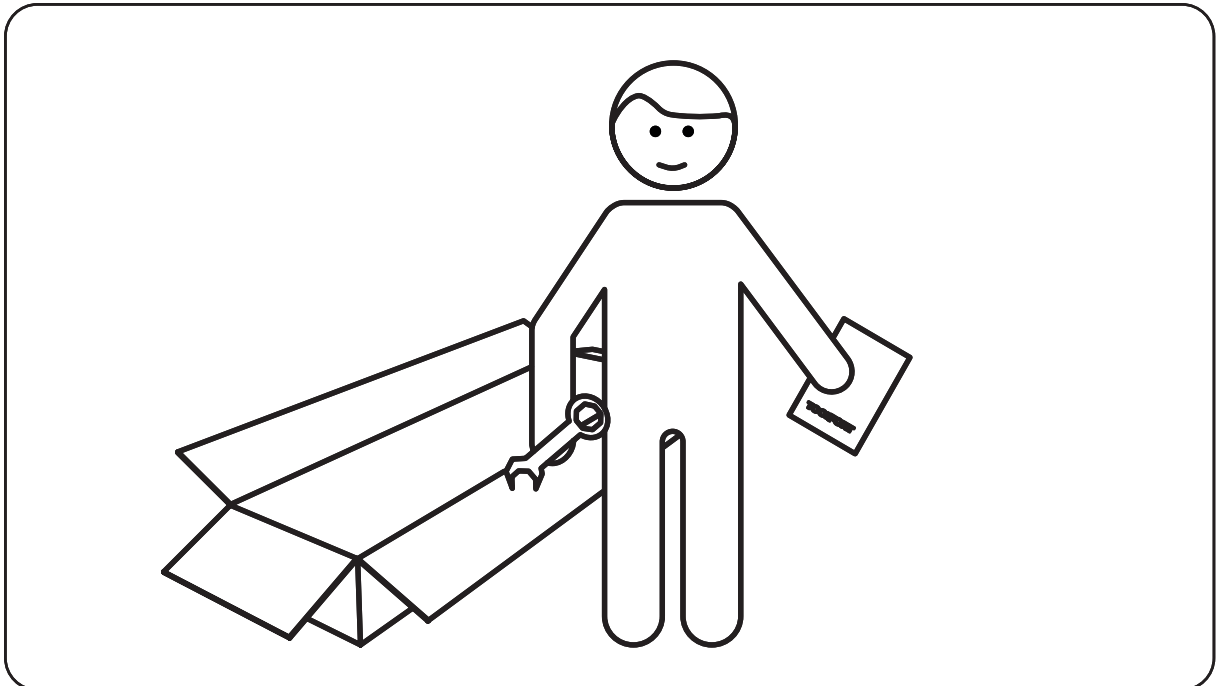



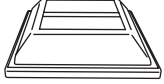
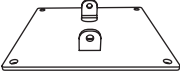

**B**

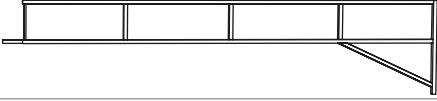
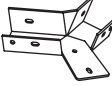
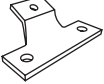

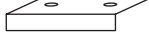
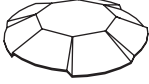
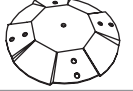

















**C**

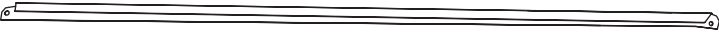

 **GG-L1-Q1 4 m x 4 m**



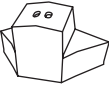

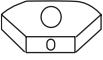
Item no.		Q'ty
35044		4
35045		4
35046		4
39090		4
39091		4
39012		4
35096		8
35097		4
35070		4
39014		1
39013		1
39015	 	4
39016	 	8
39017	 	4

 **GG-L1-Q1 4 m x 4 m**



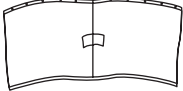
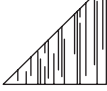

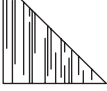
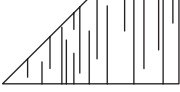
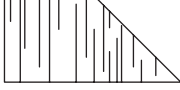









Item no.		Q'ty
39022	 	4
39023	 	4
39024	 	4
39019		4
39020		4
39021		4
39025		4
39026		4
39027		4
39028		4
39029		4
39030		4
39031		4
39032		4
39033		8
39034		4



# GG-L1-Q1 4 m x 4 m

Item no.		Q'ty
39035		4
		4
39036		4
39037		8
39038		4
39039		4
39040		4
39041		4

 **GG-L1-Q1 4 m x 4 m**

Item no.		Q'ty
35085	M6 15 mm 	8
35087	M6 15 mm 	97
35578	M6 15 mm 	40
35089	M6 35 mm 	8
39043	M6 40 mm 	8
35143		24
35142	M6 25 mm 	8
35137	M10 80 mm 	8
35144	M6 	2
35145		1
35146		1
35088	M6 	72
35086	M6 	201
35154	M6 	121
39423	M6 	48

 **GG-L1-Q1 4 m x 4 m**

1

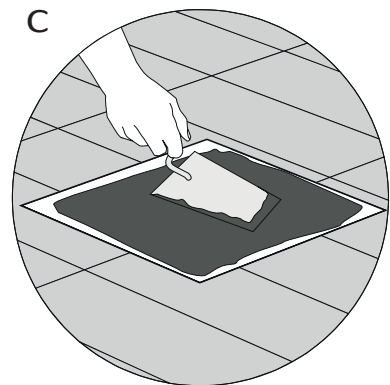
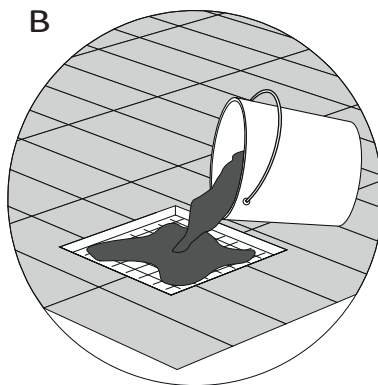
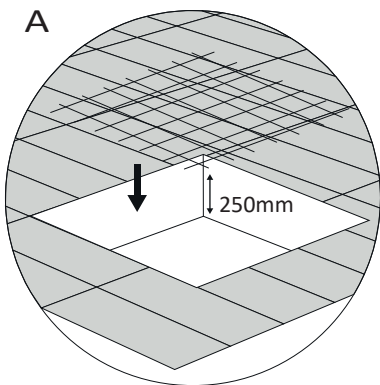
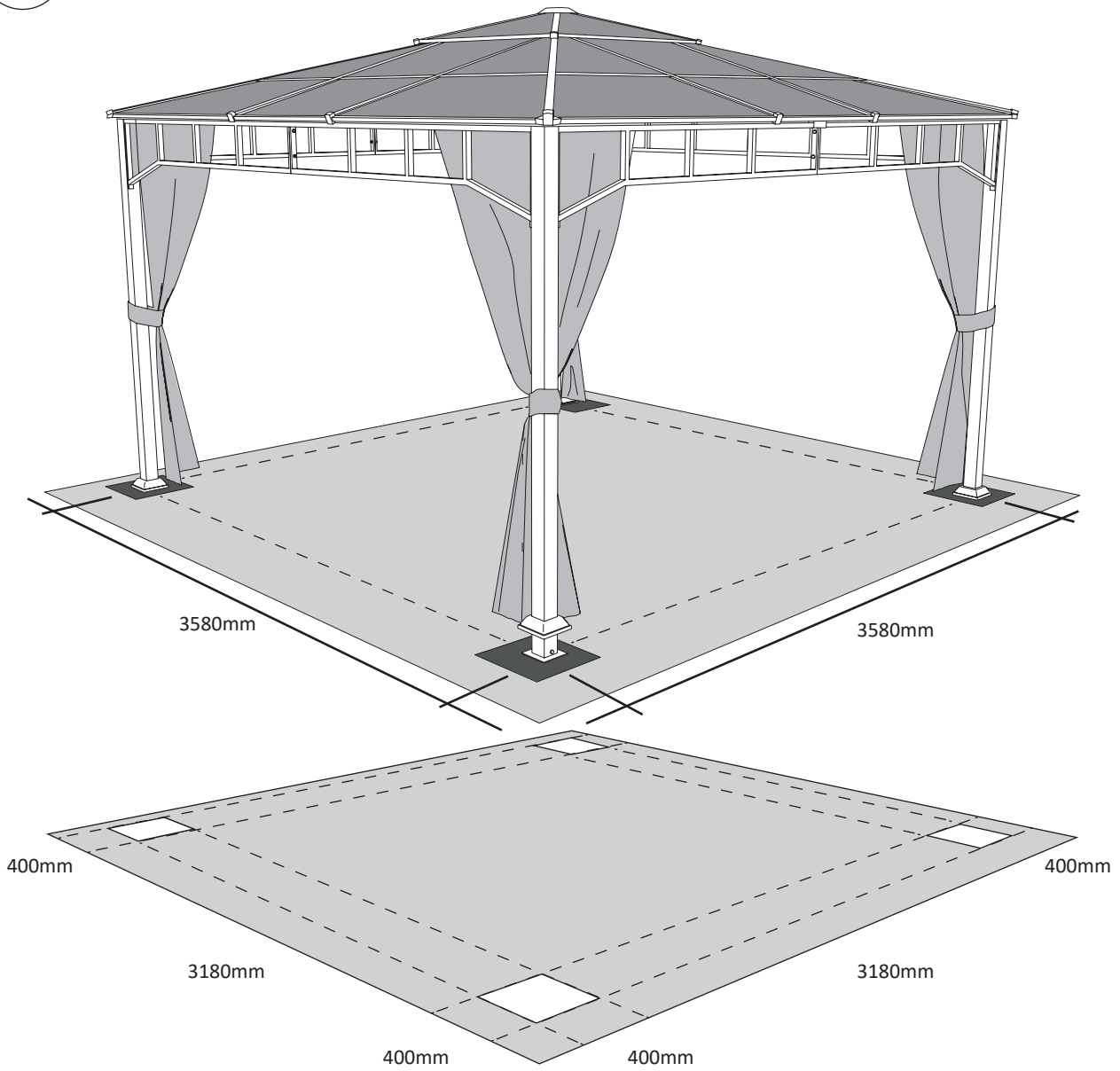



 **GG-L1-Q1 4 m x 4 m**

2

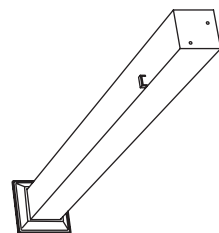
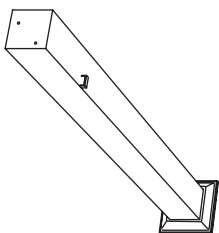
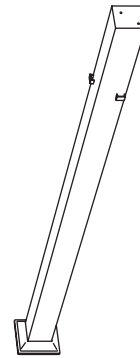
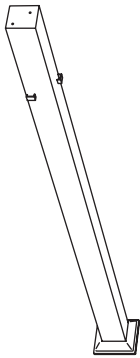
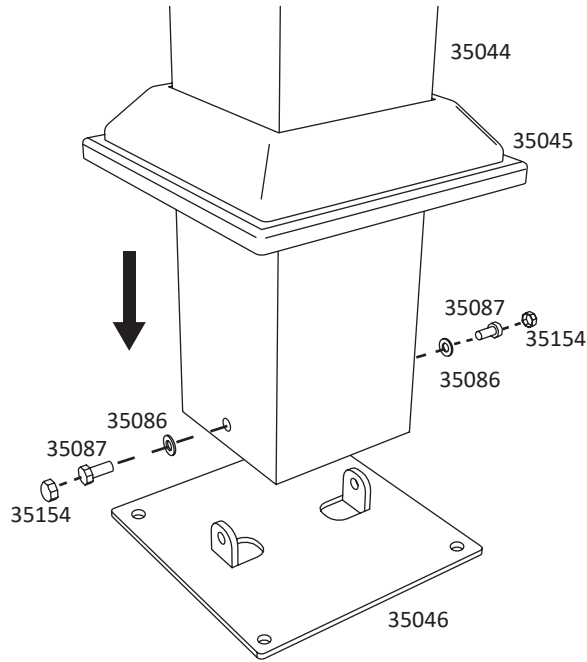
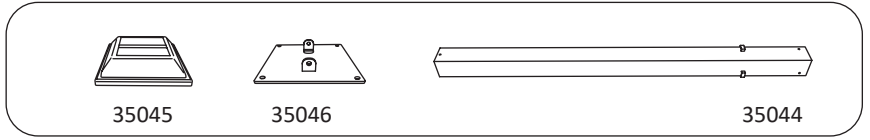
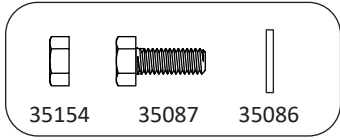

 **GG-L1-Q1 4 m x 4 m**

3

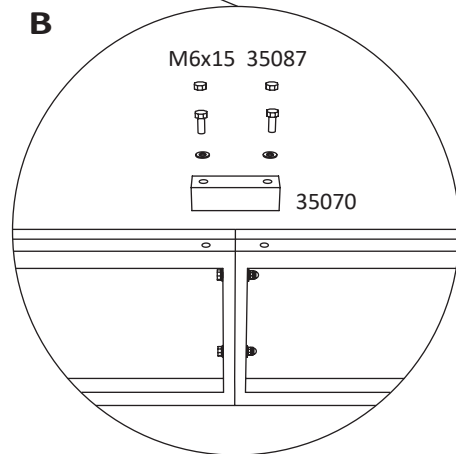
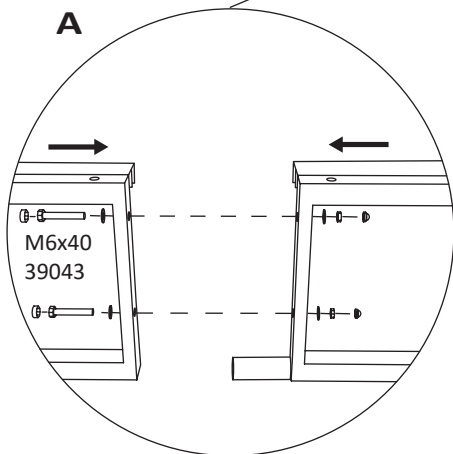
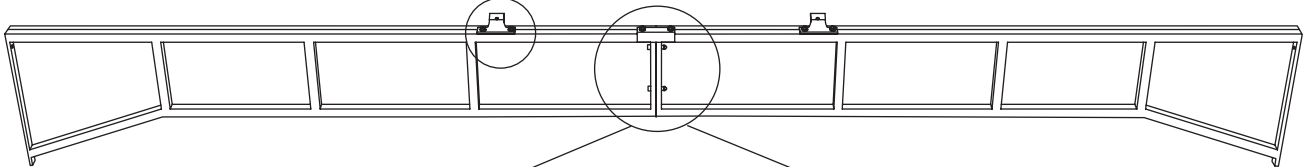
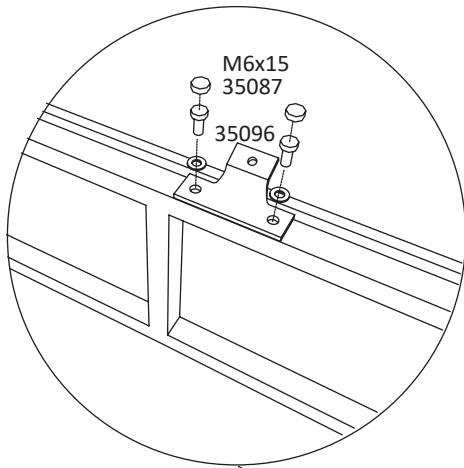
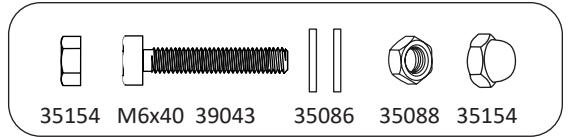
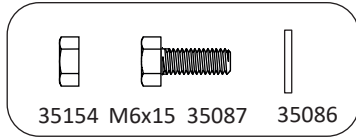
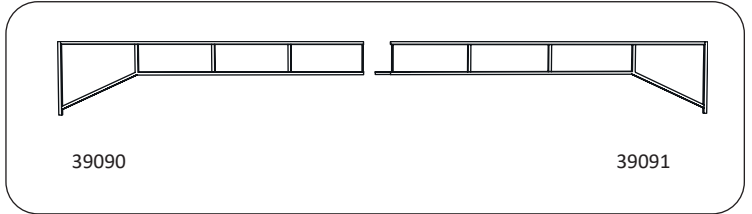
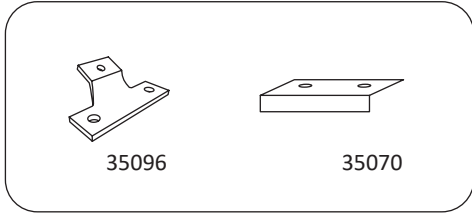

 **GG-L1-Q1 4 m x 4 m**

4

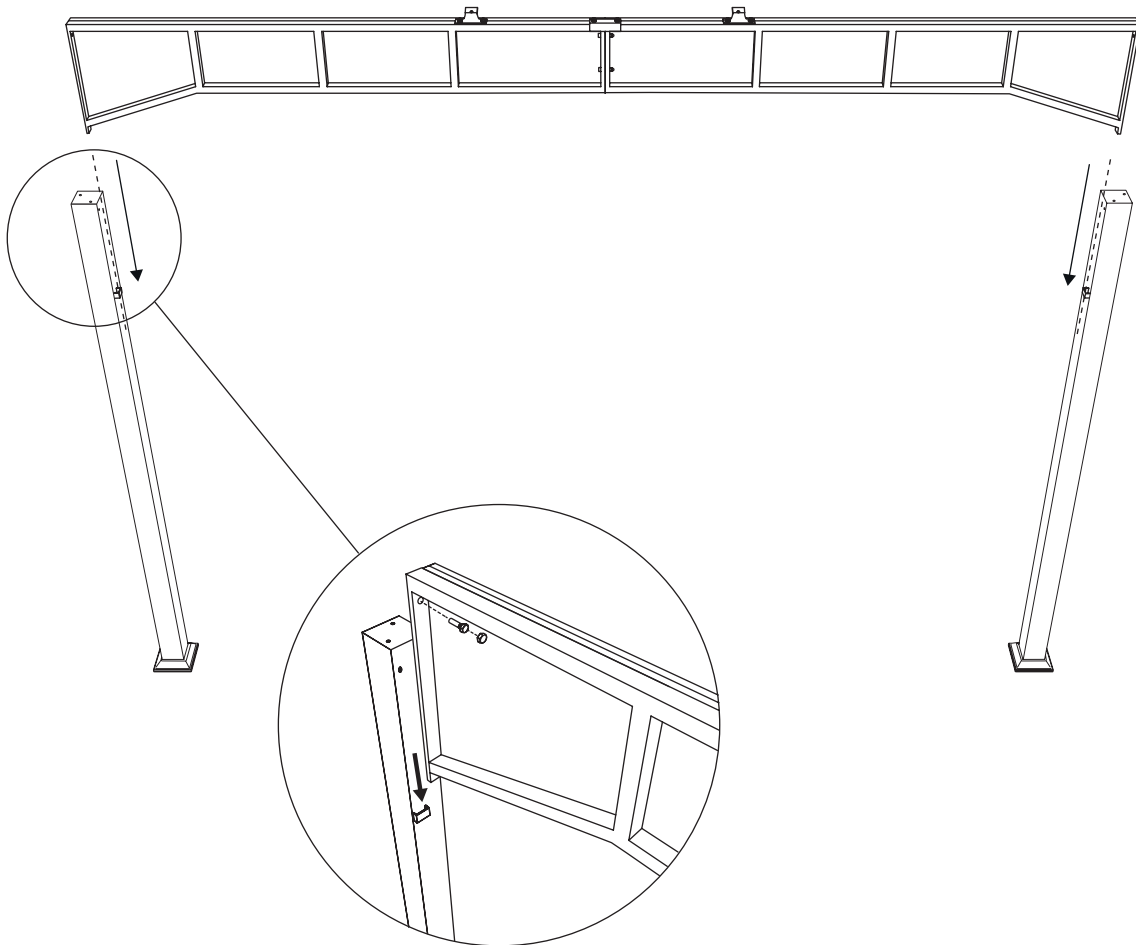
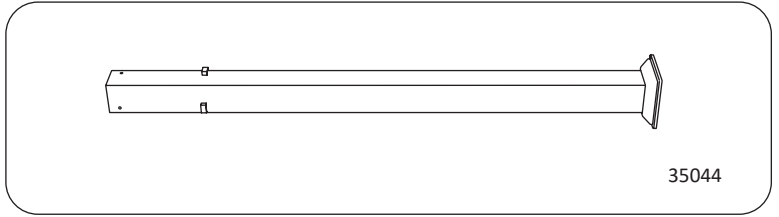
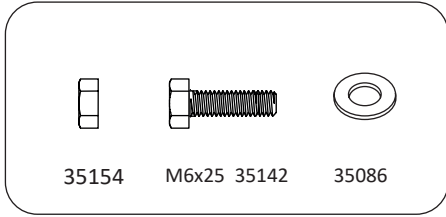

5

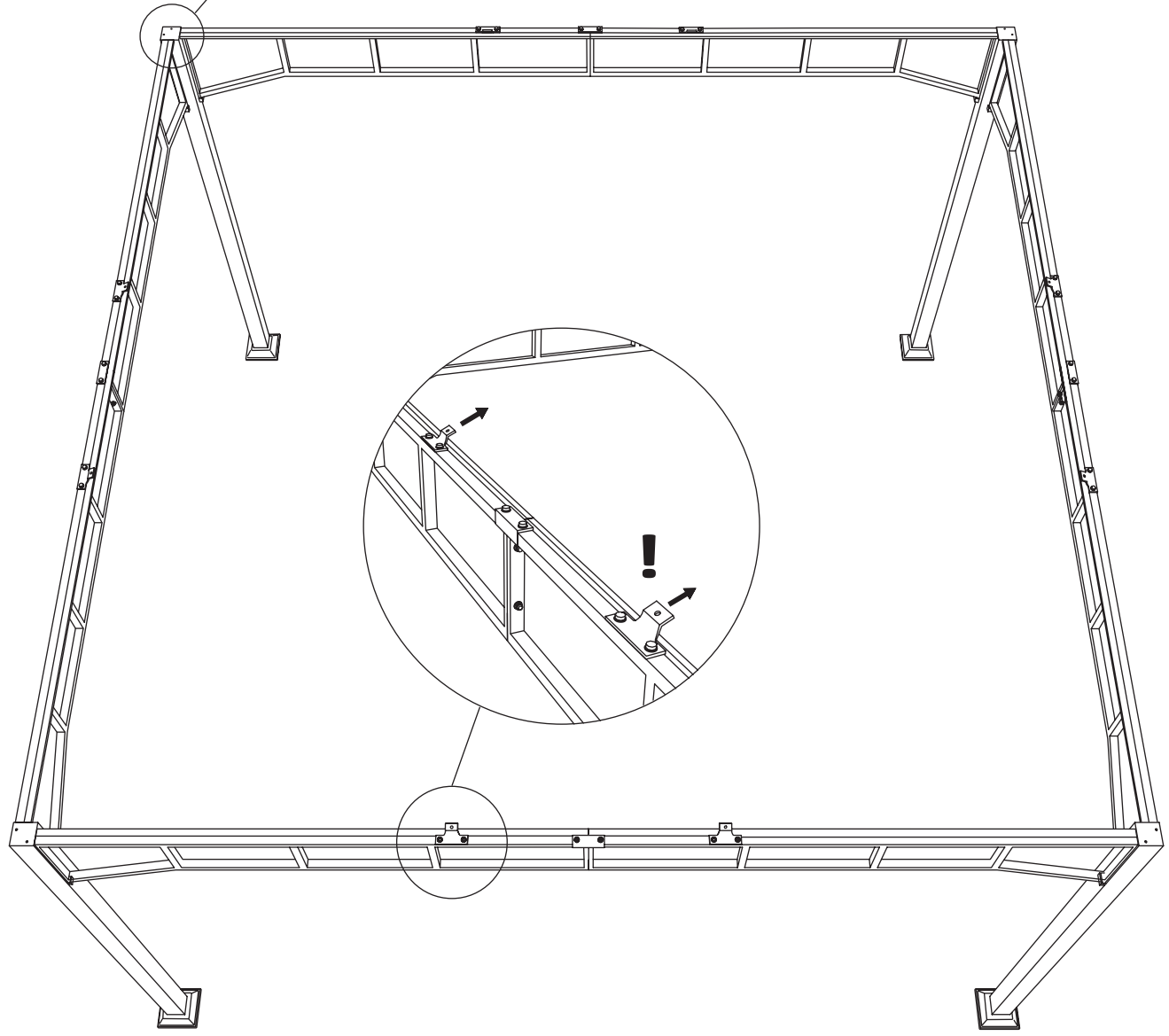
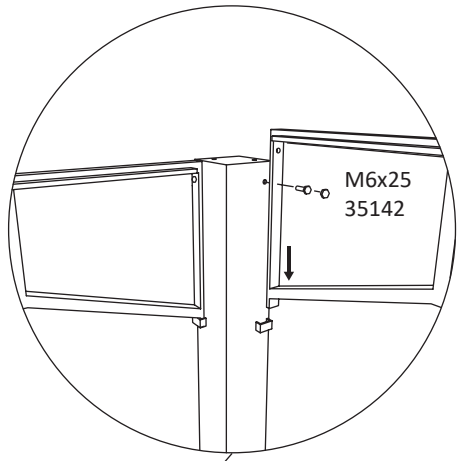
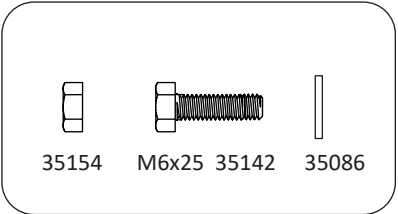

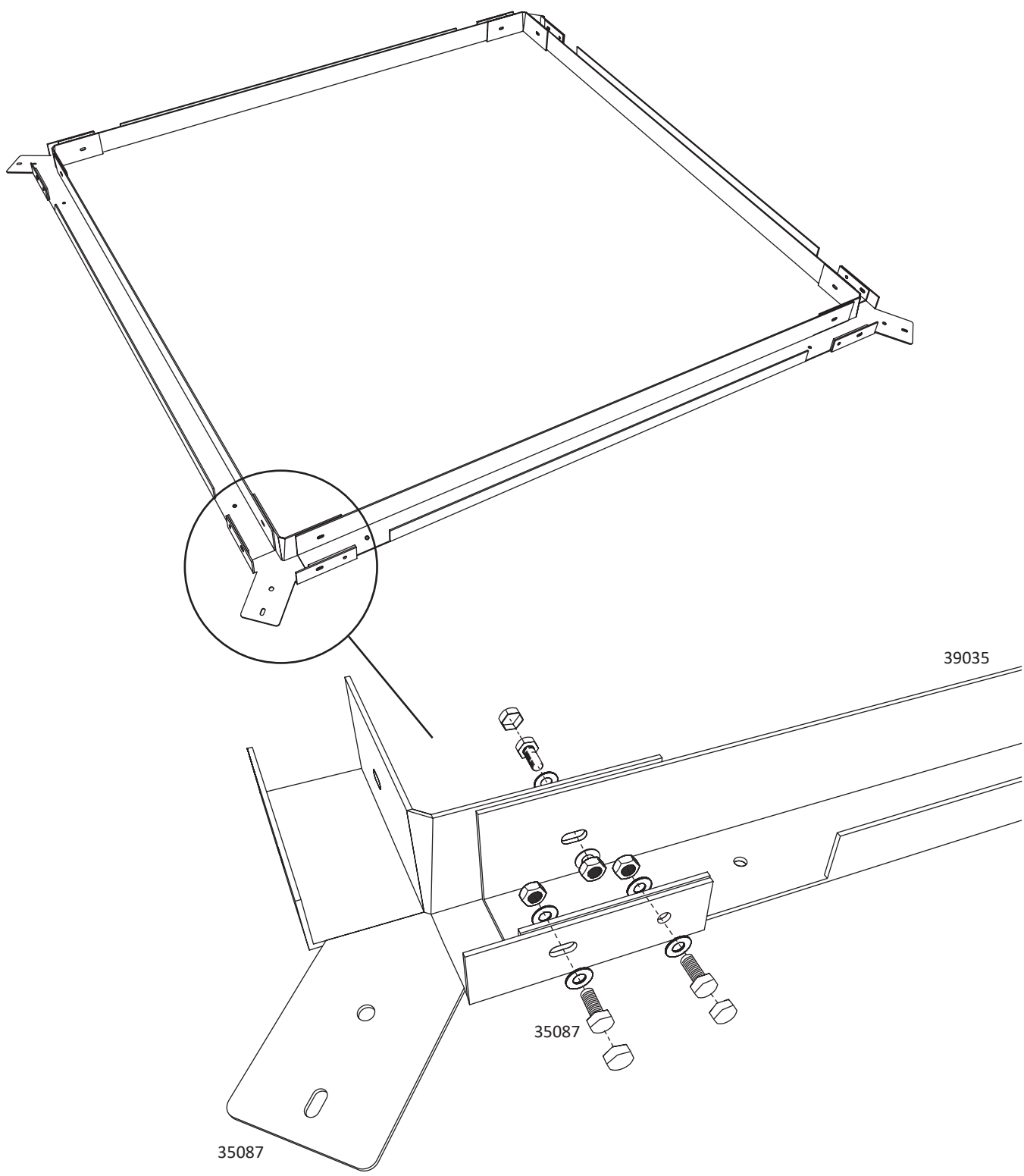
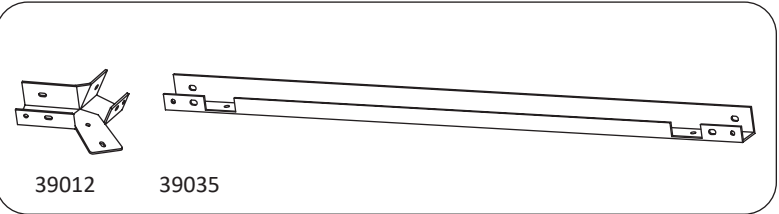
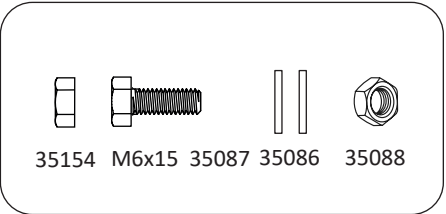

6

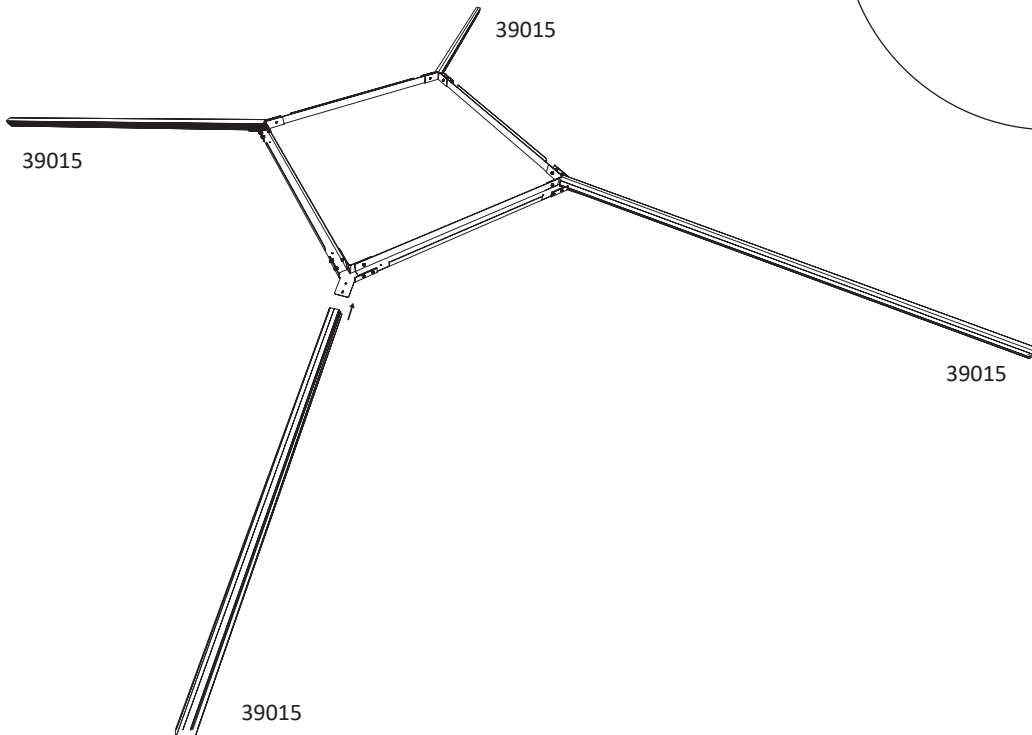
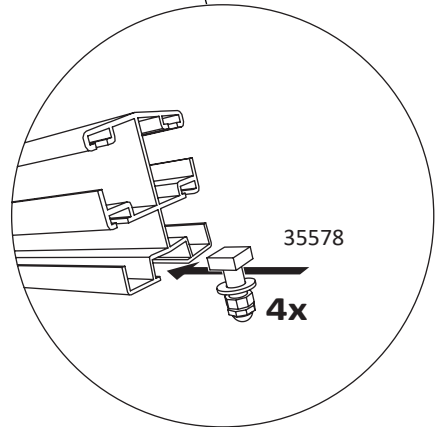
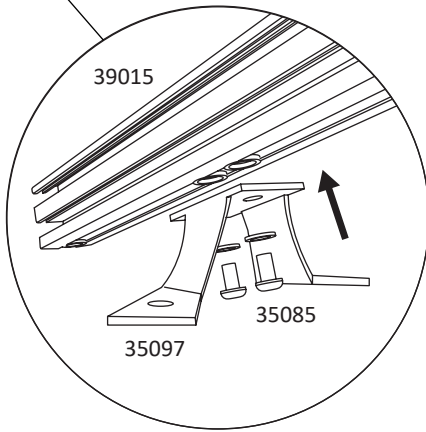
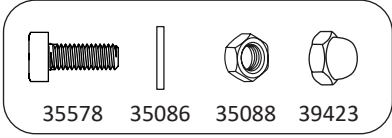
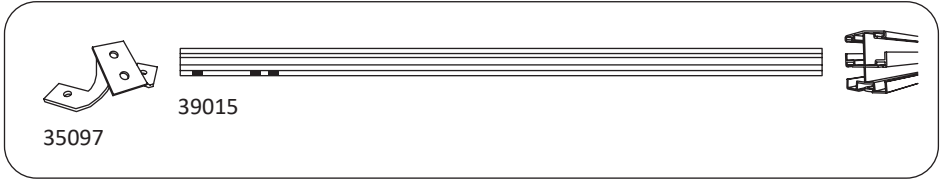
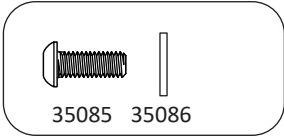

# GG-L1-Q1 4 m x 4 m

7



 **GG-L1-Q1 4 m x 4 m**

8

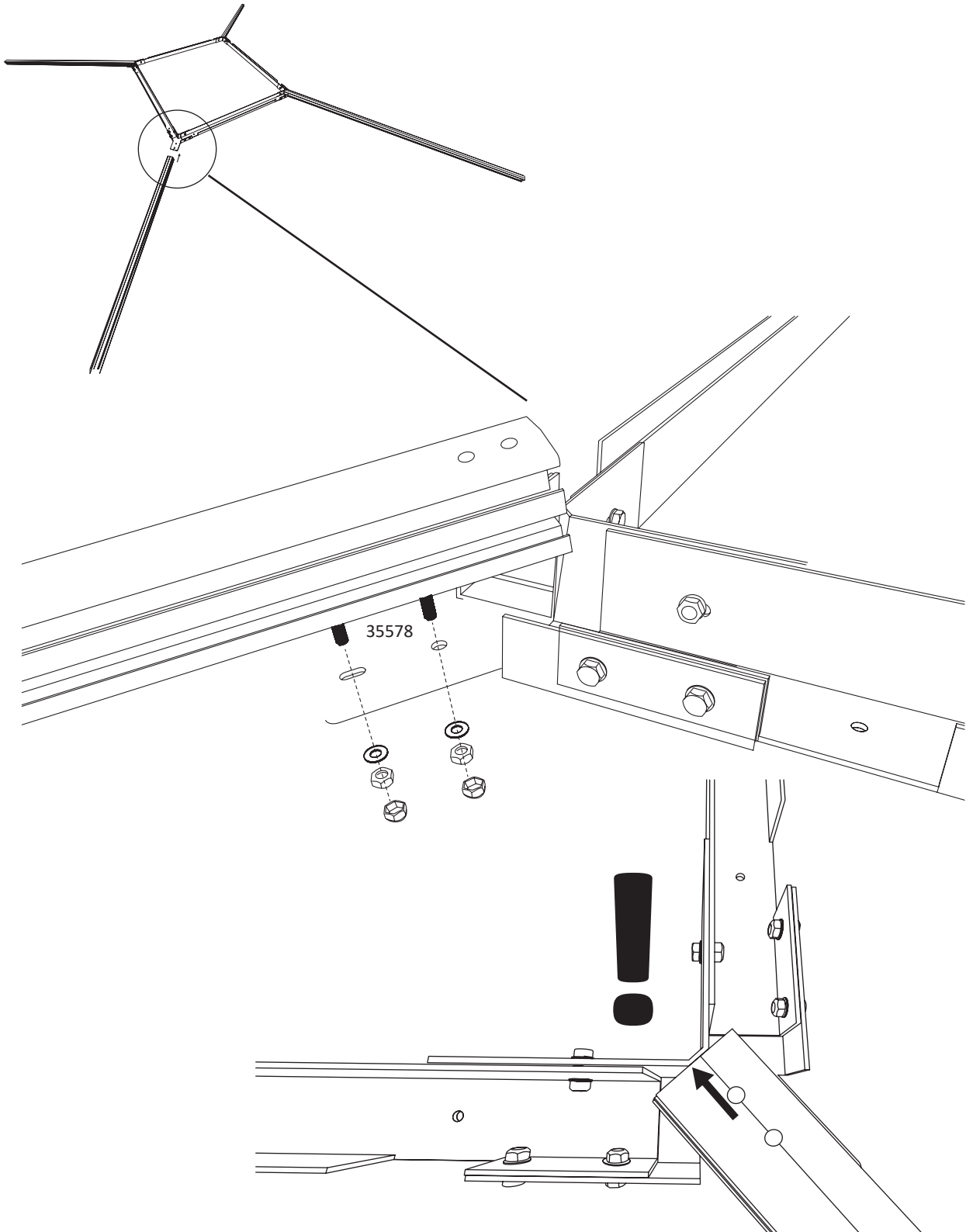
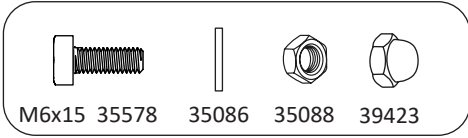

 **GG-L1-Q1 4 m x 4 m**

9

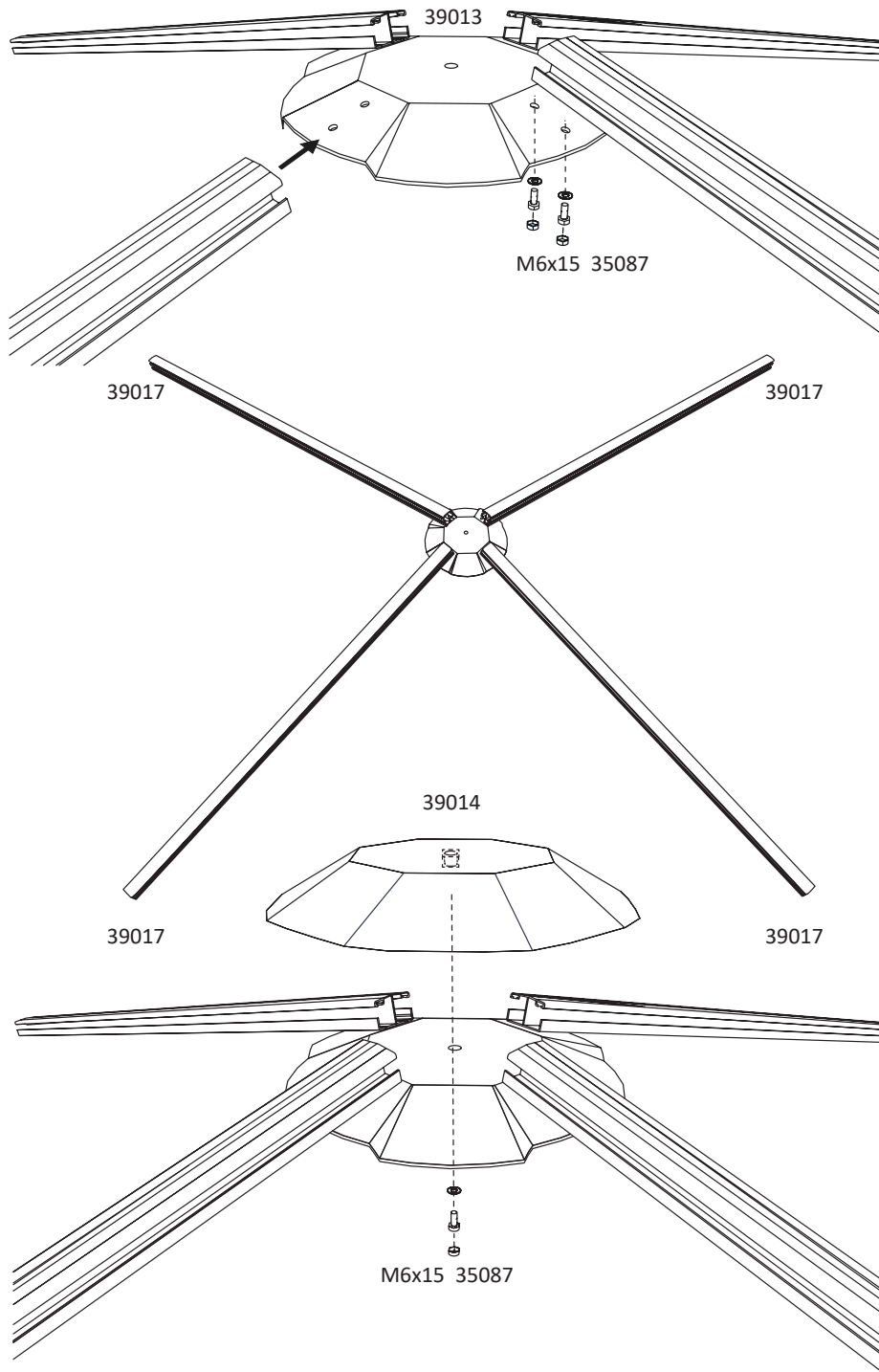
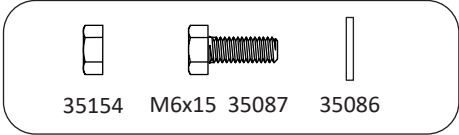
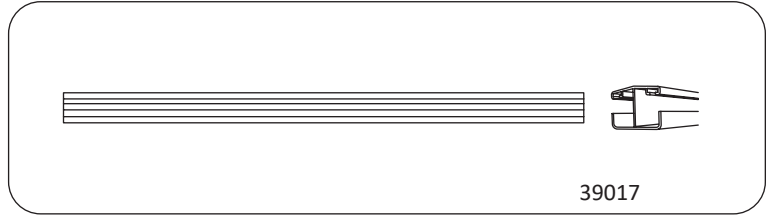
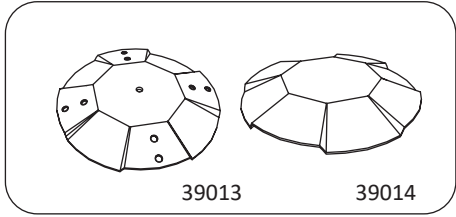



 **GG-L1-Q1 4 m x 4 m**

10

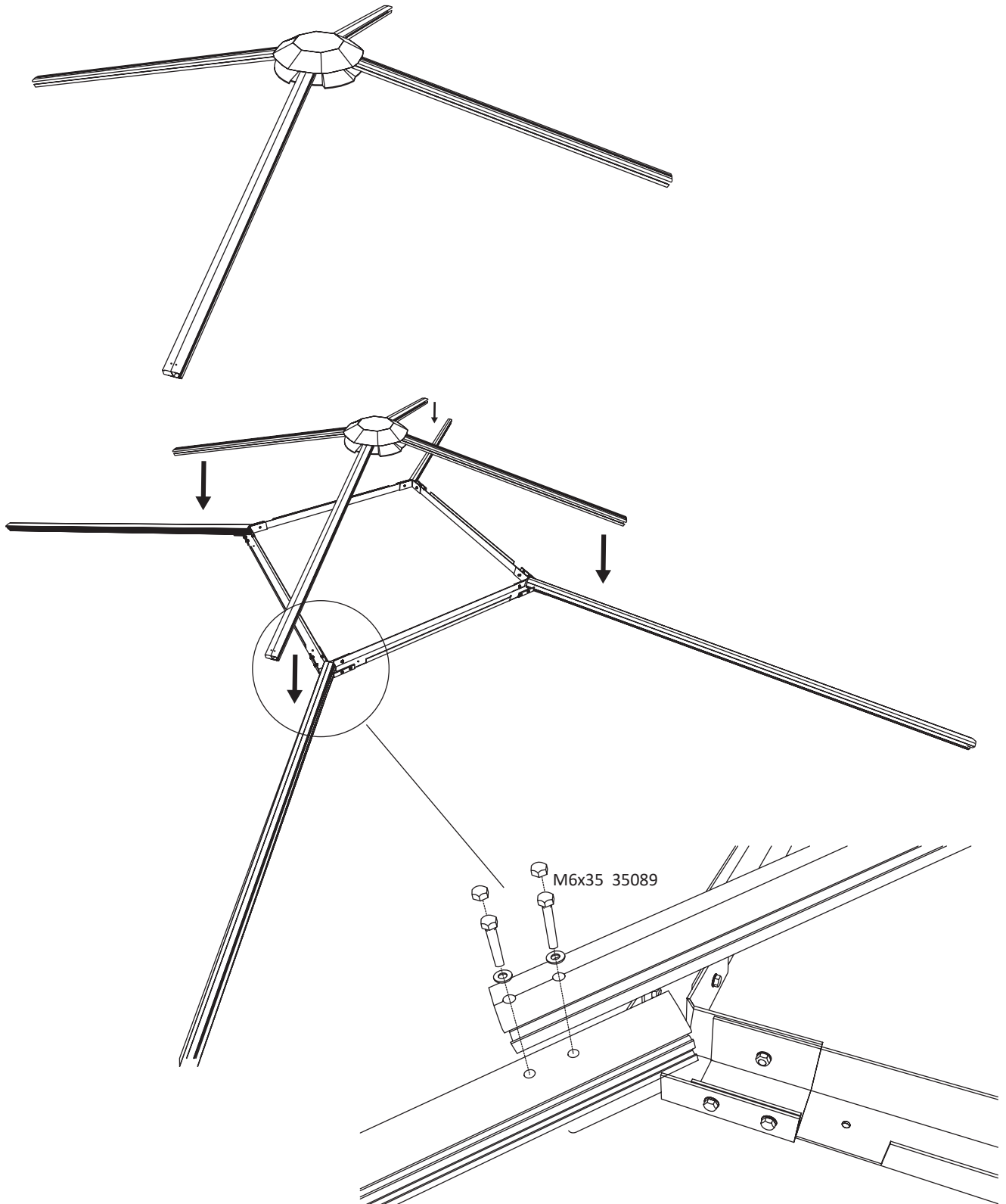
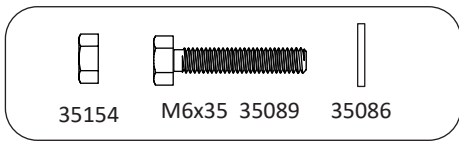

 **GG-L1-Q1 4 m x 4 m**

11

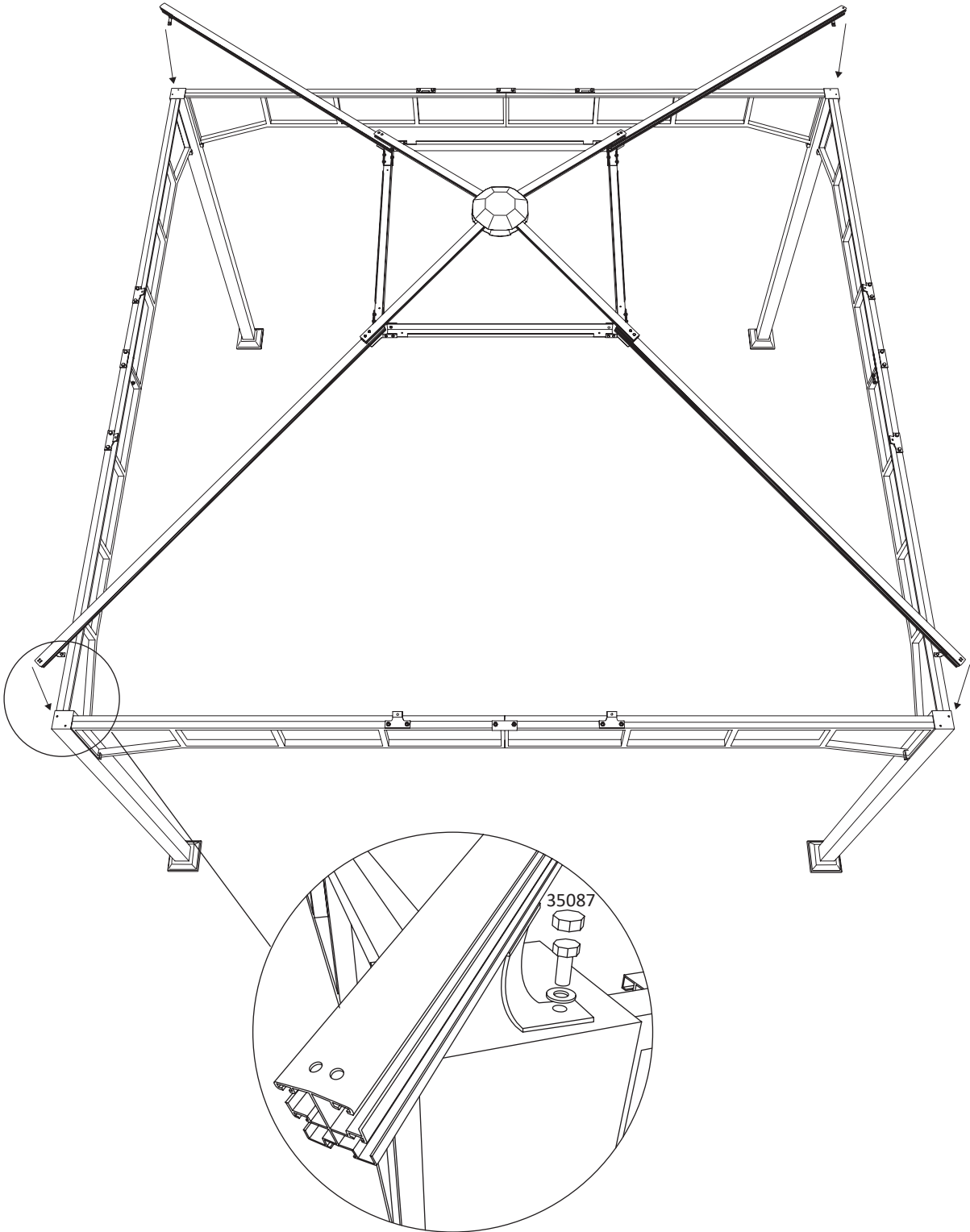
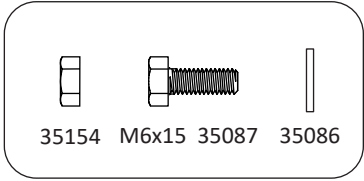

# GG-L1-Q1 4 m x 4 m

12

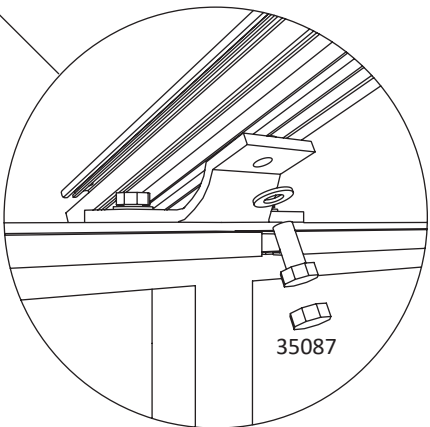
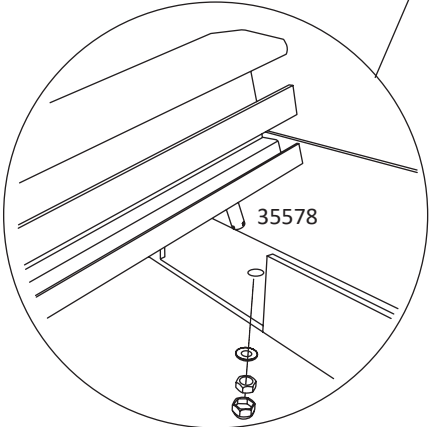
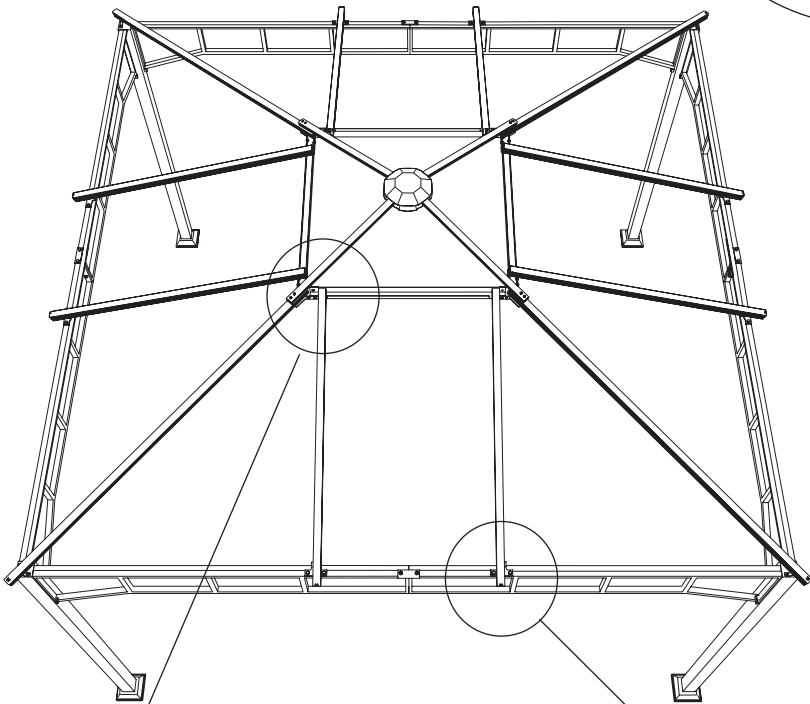
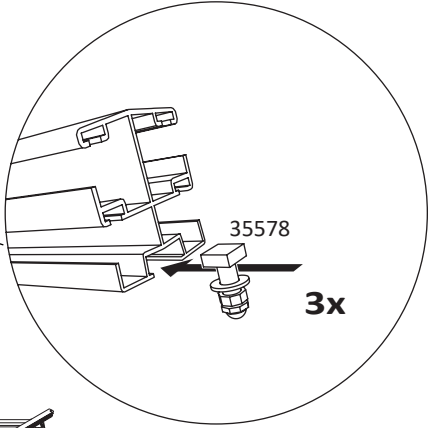
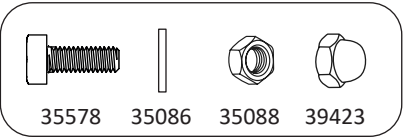
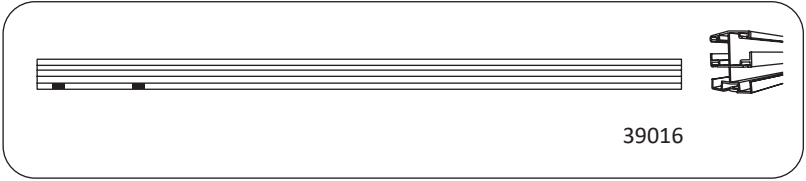
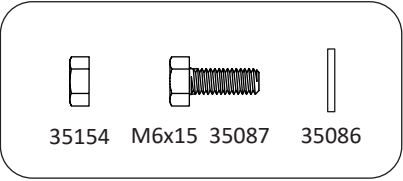

# GG-L1-Q1 4 m x 4 m



39041

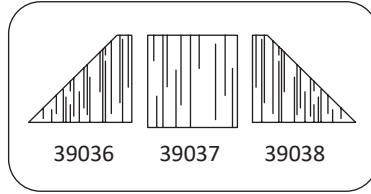

39036

39037

39038

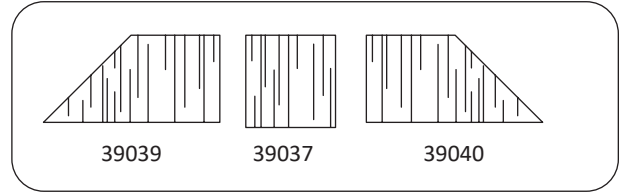



39039

39037

39040

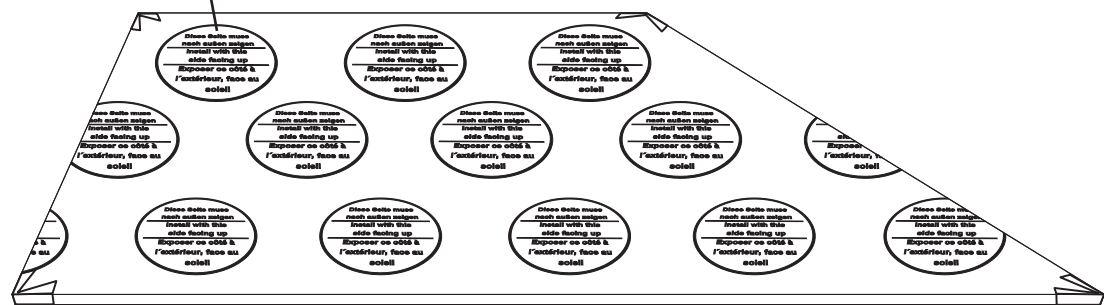
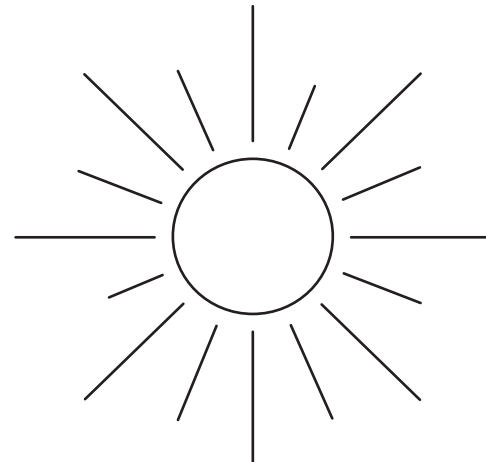
**Diese Seite muss  
nach außen zeigen**  
**Install with this  
side facing up**  
**Exposer ce côté à  
l'extérieur, face au  
soleil**



 **GG-L1-Q1 4 m x 4 m**

13

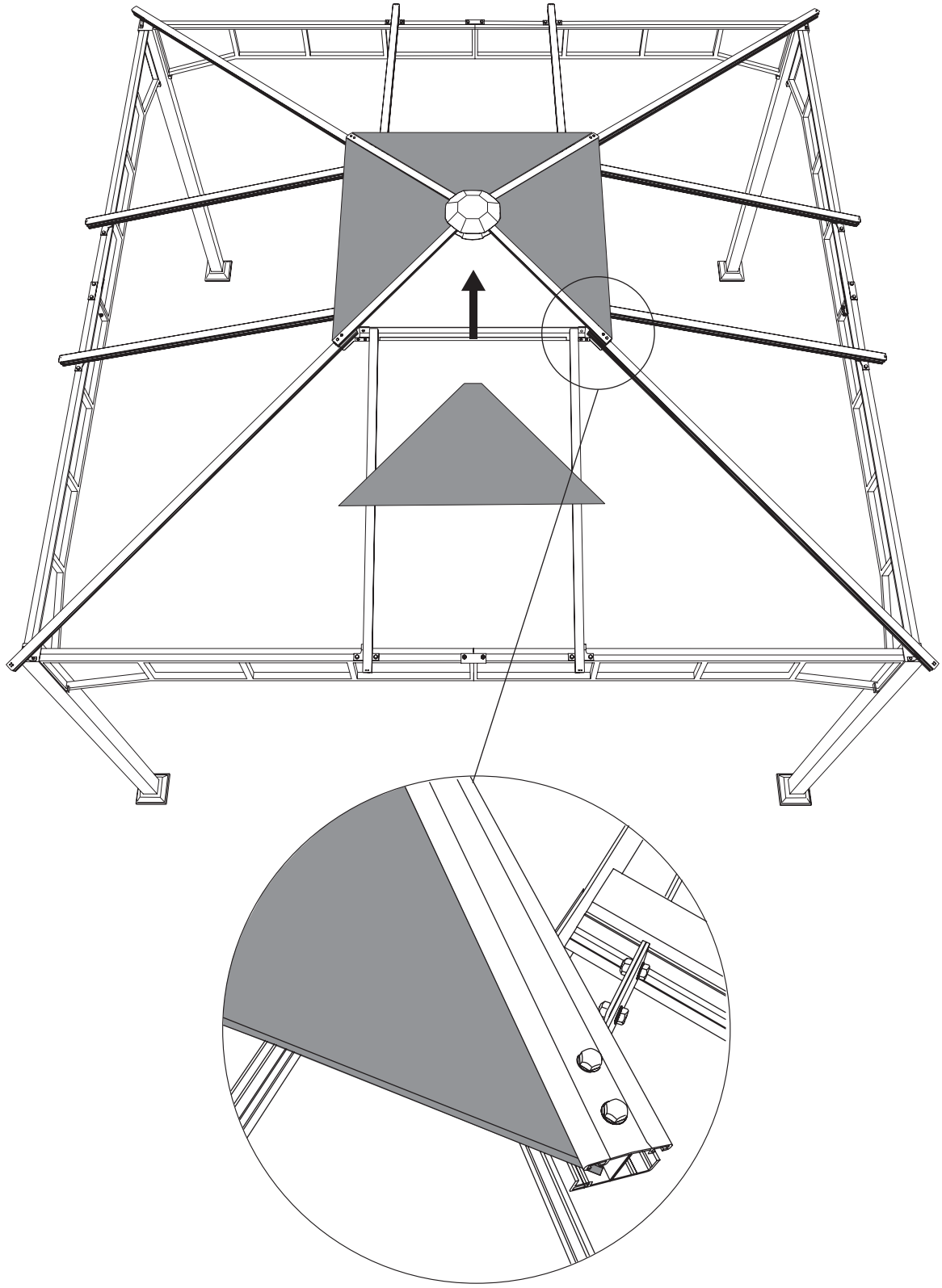

 **GG-L1-Q1 4 m x 4 m**

14

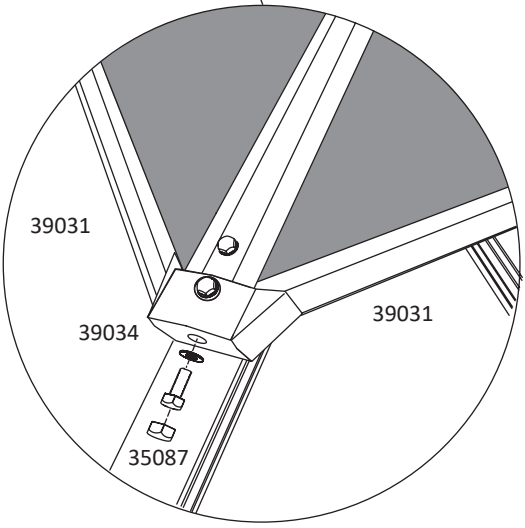
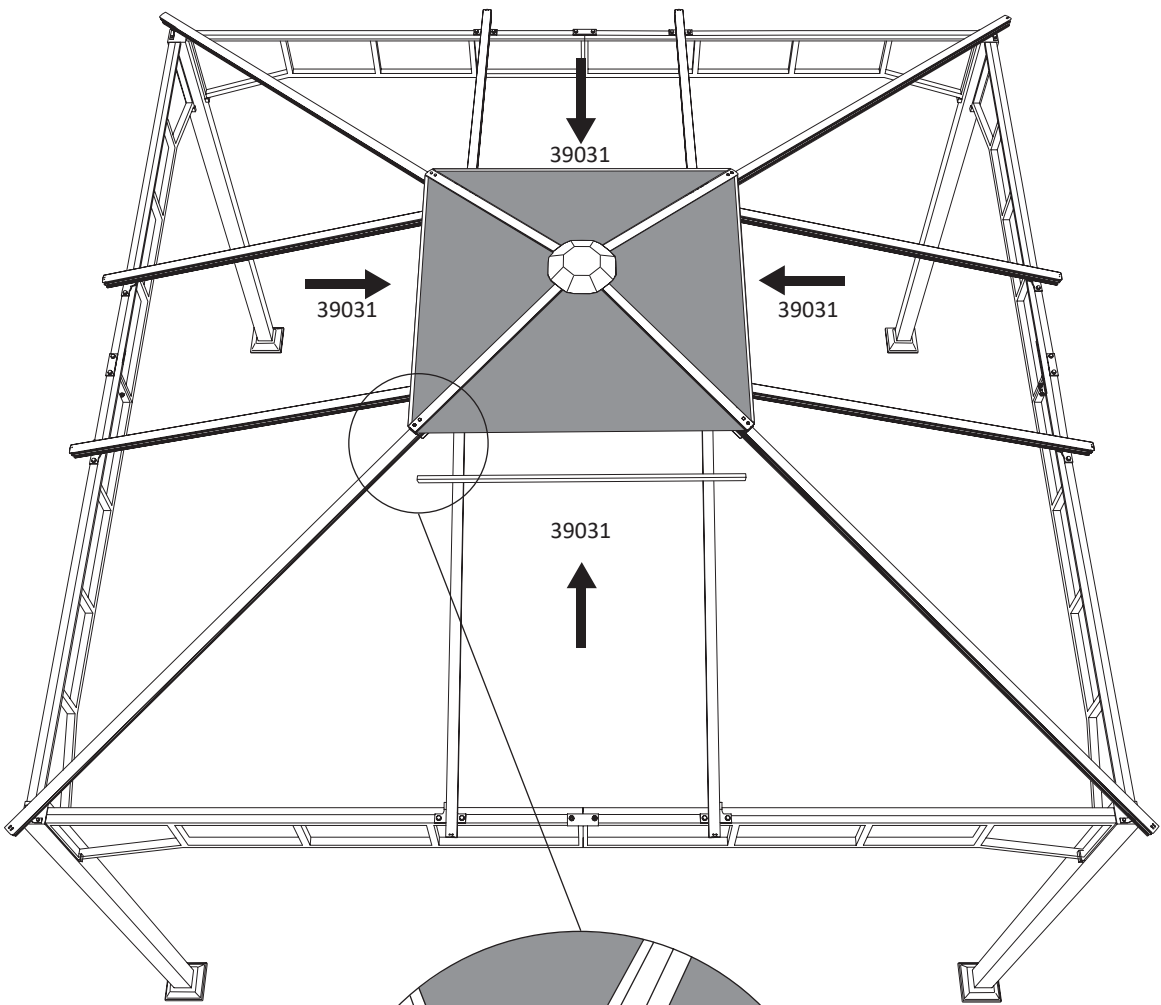
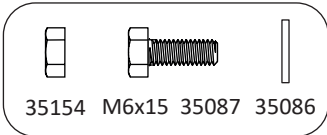
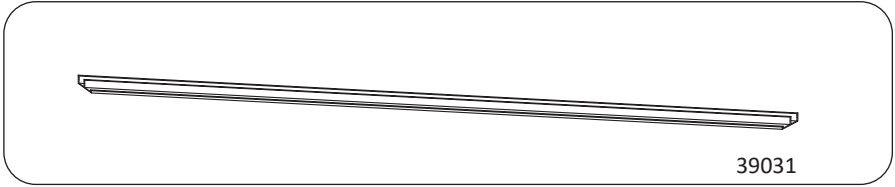
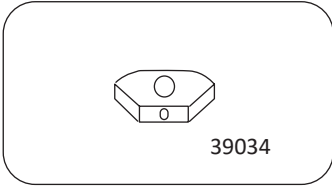

 **GG-L1-Q1 4 m x 4 m**

15

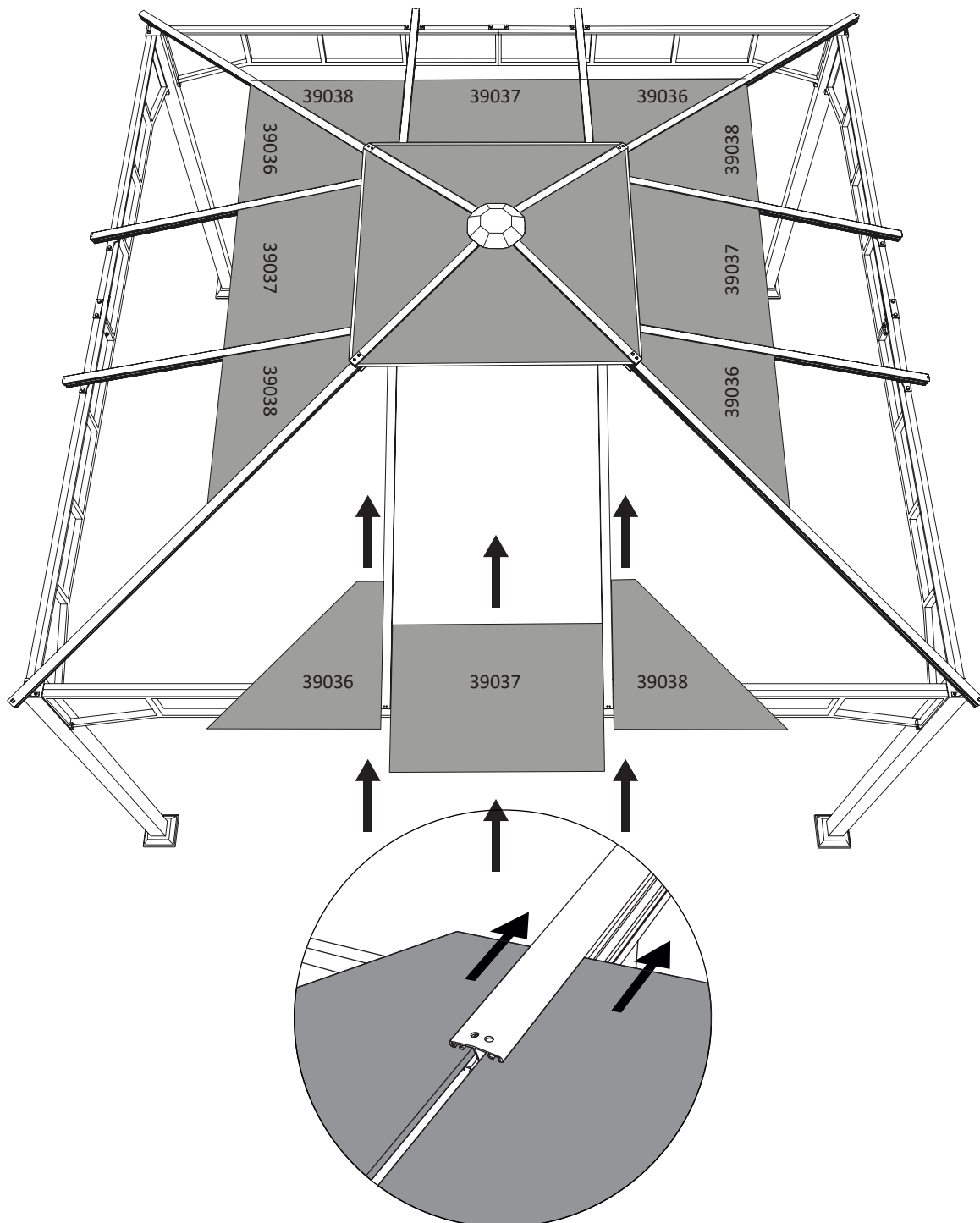
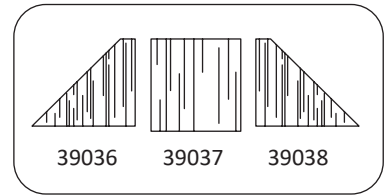

 **GG-L1-Q1 4 m x 4 m**

16

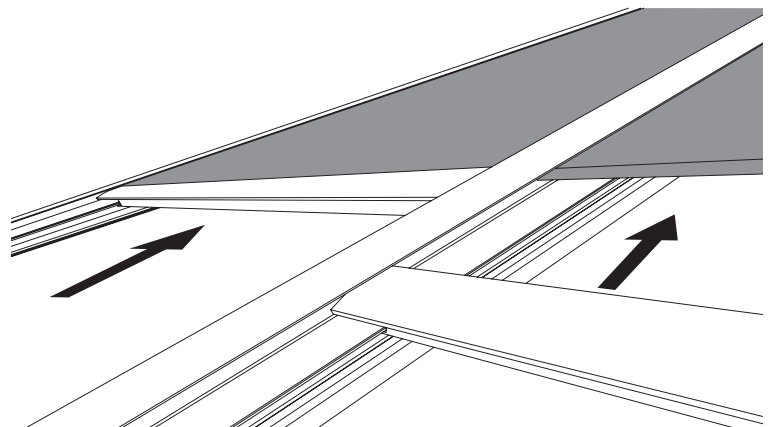
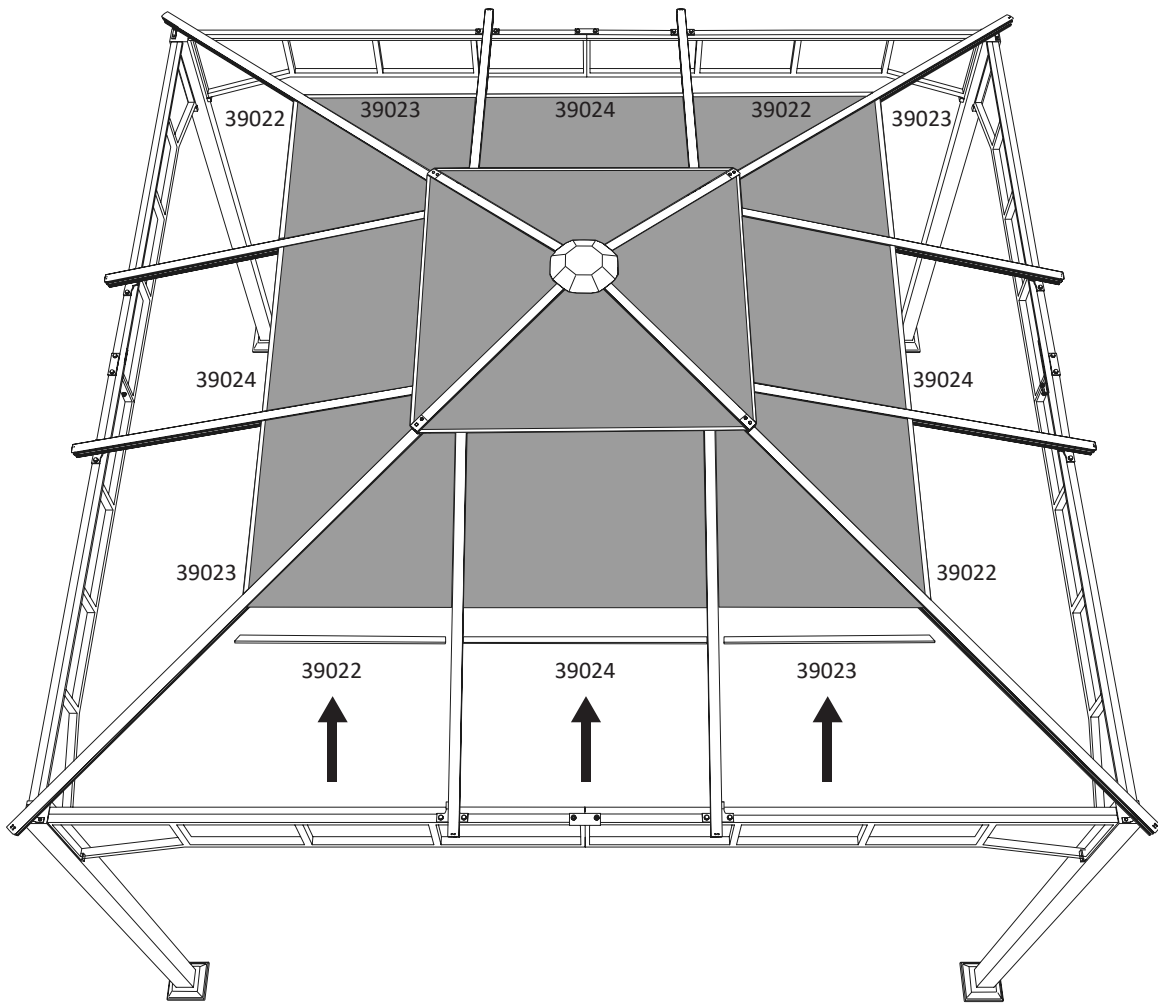
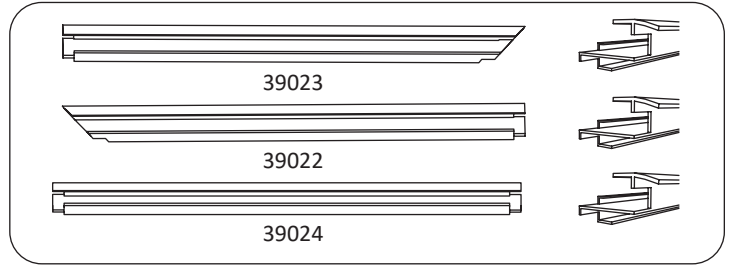



 **GG-L1-Q1 4 m x 4 m**

17

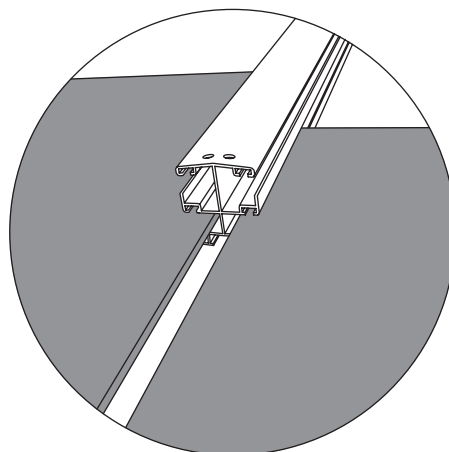
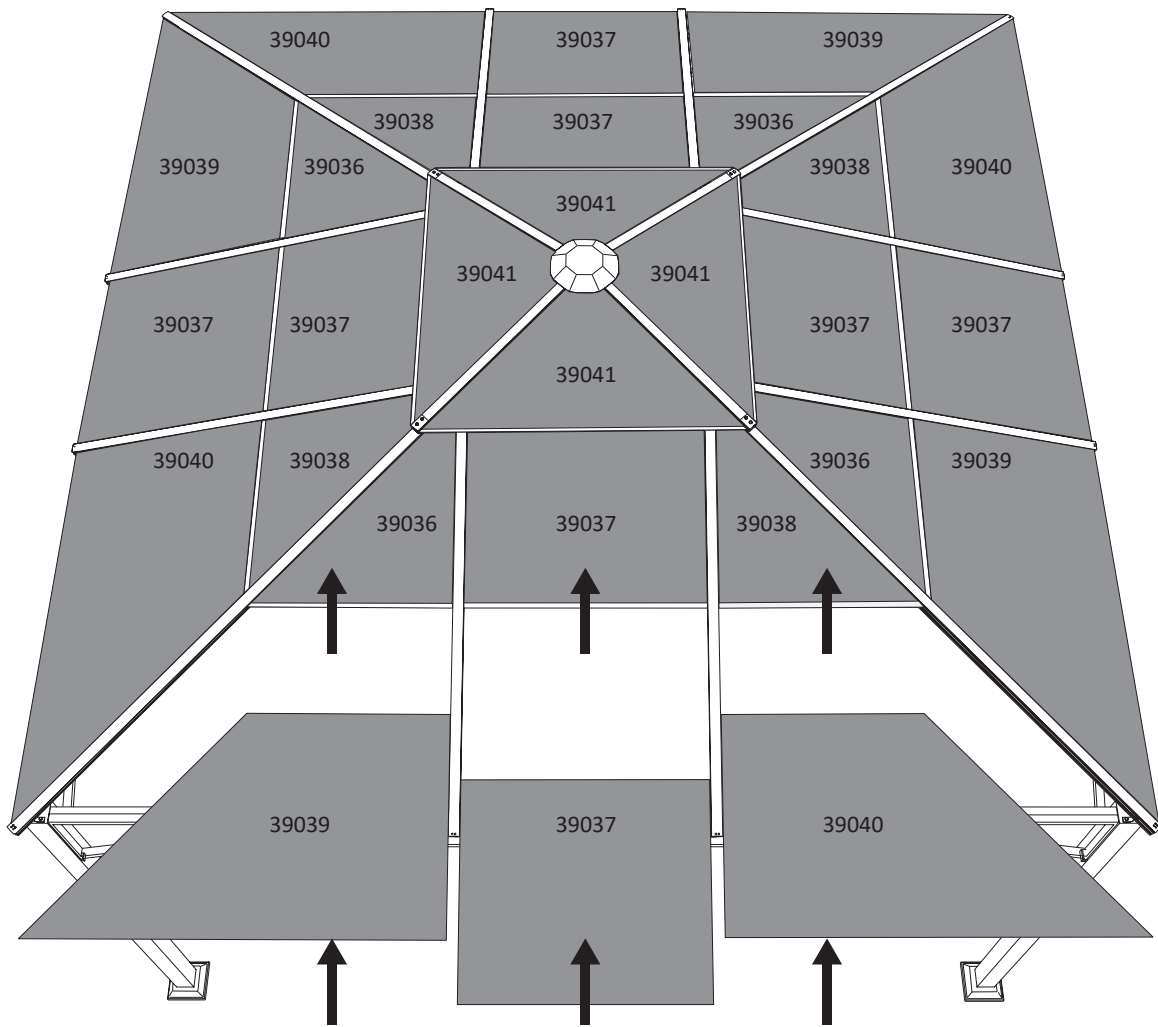
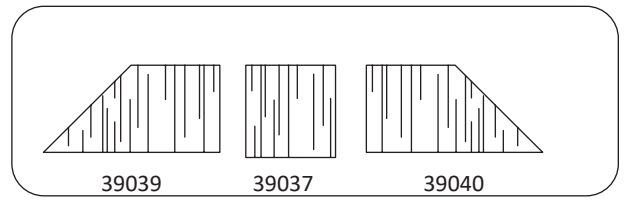

 **GG-L1-Q1 4 m x 4 m**

18

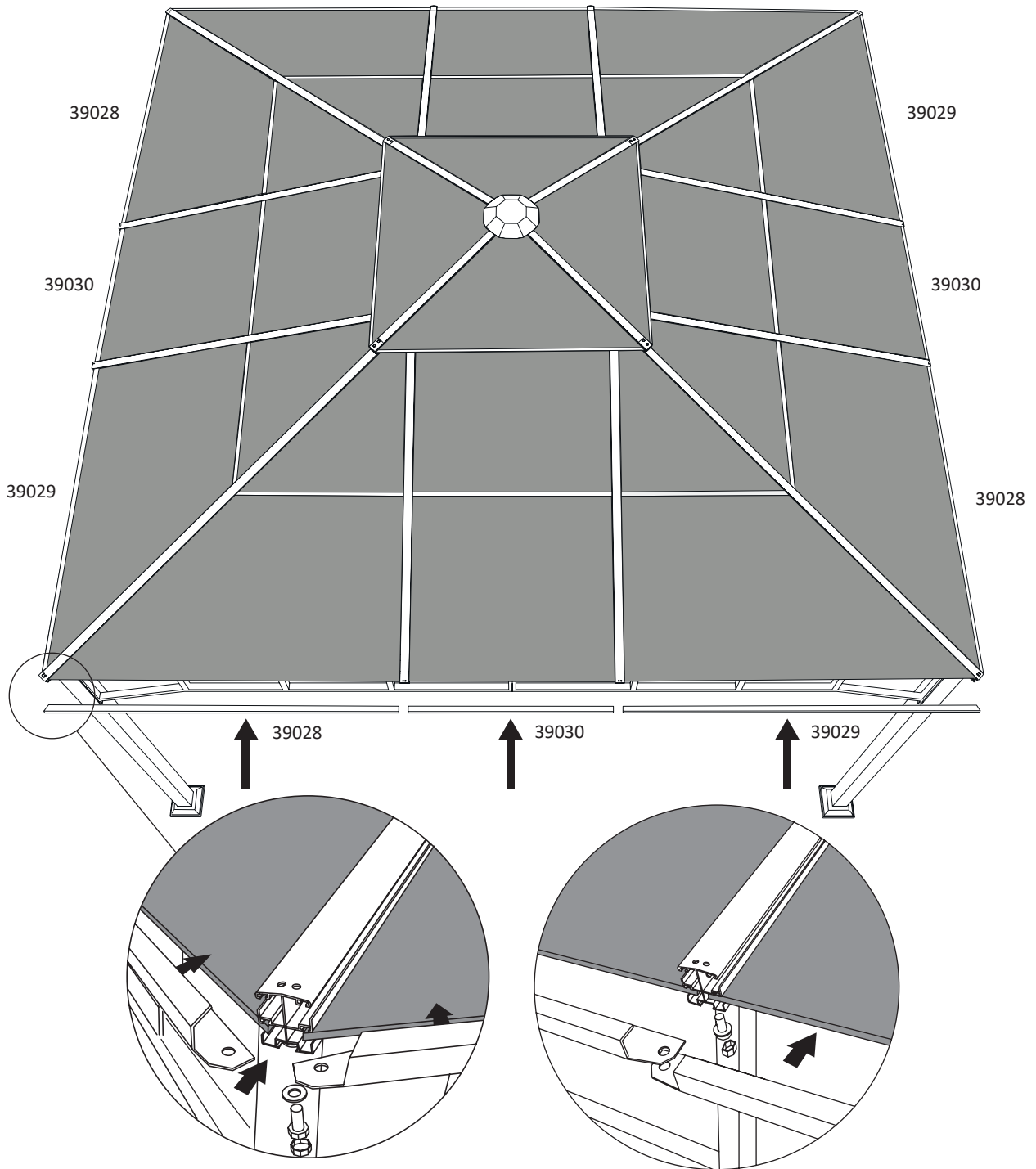
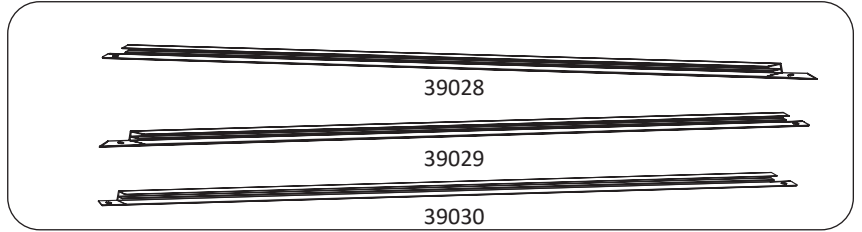
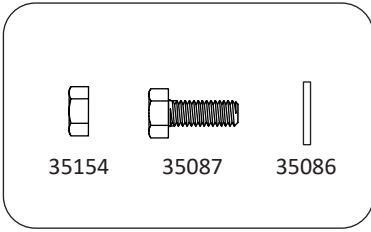

 **GG-L1-Q1 4 m x 4 m**

19

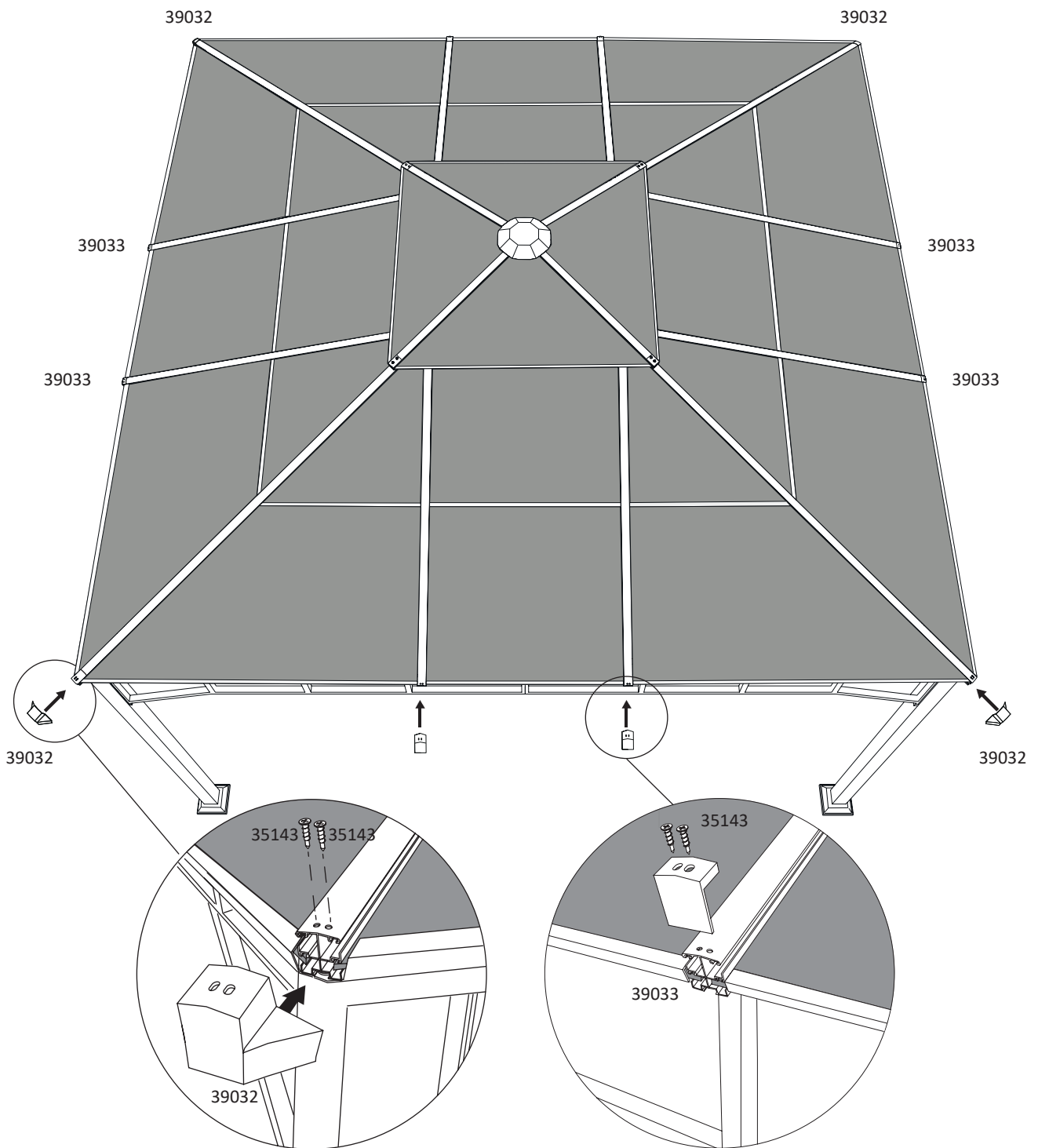
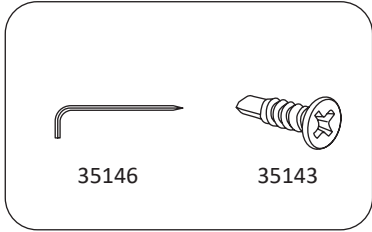
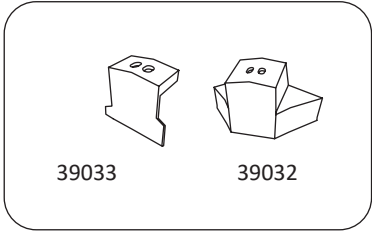

# GG-L1-Q1 4 m x 4 m

20

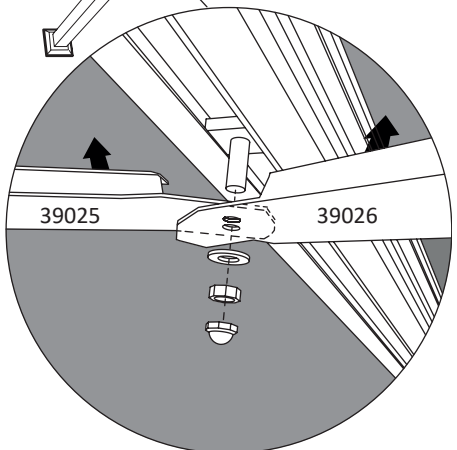
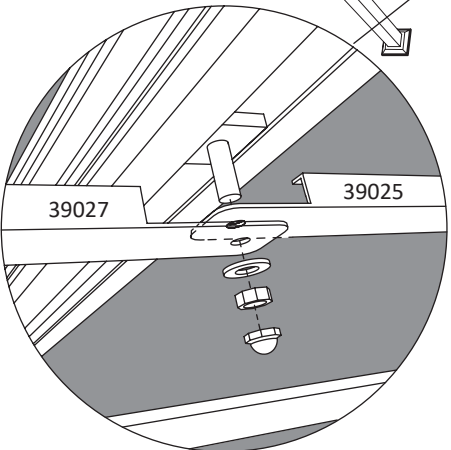
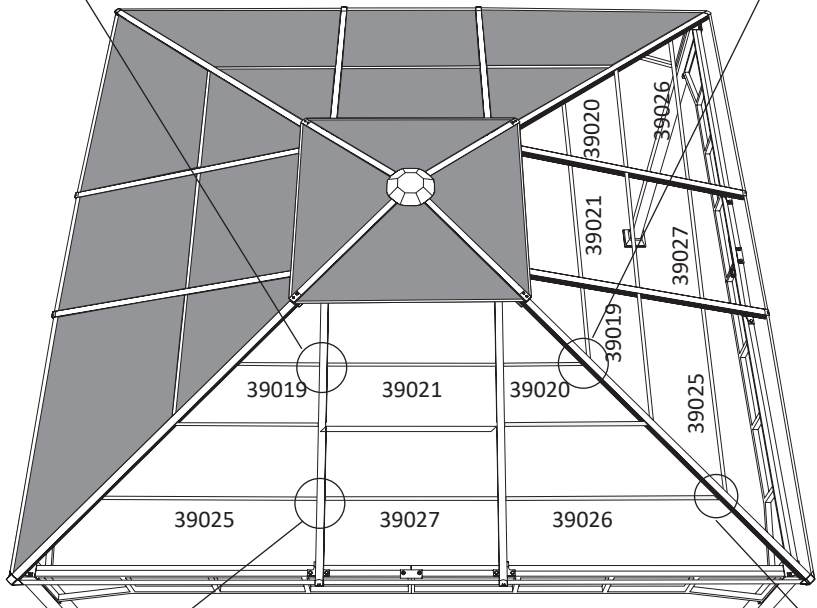
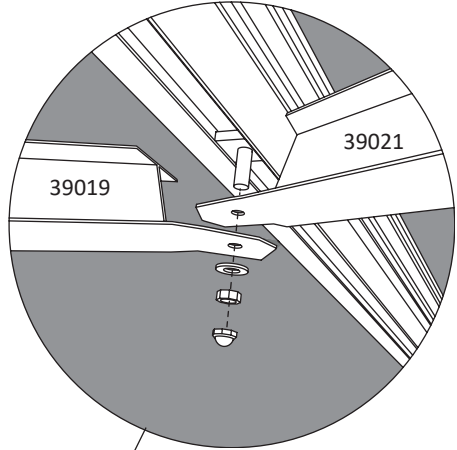
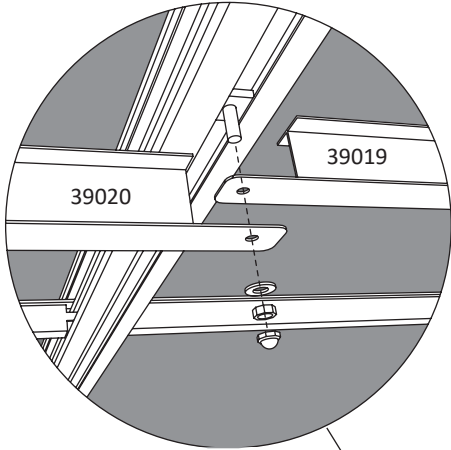
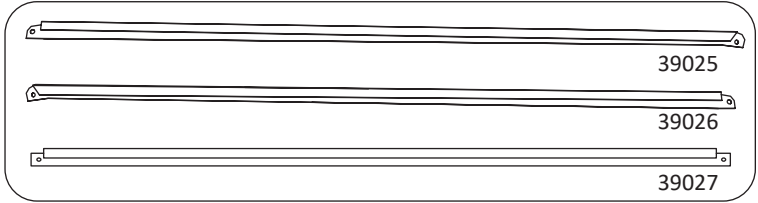
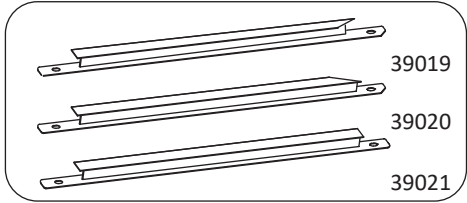

 **GG-L1-Q1** 4 m x 4 m

21

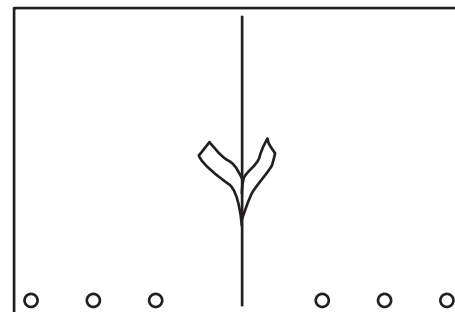
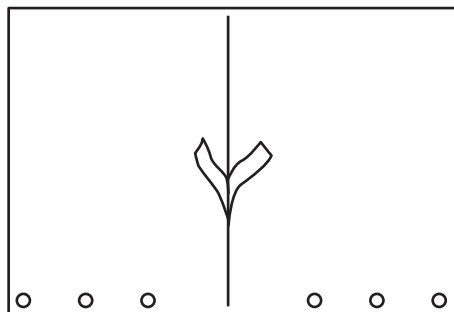
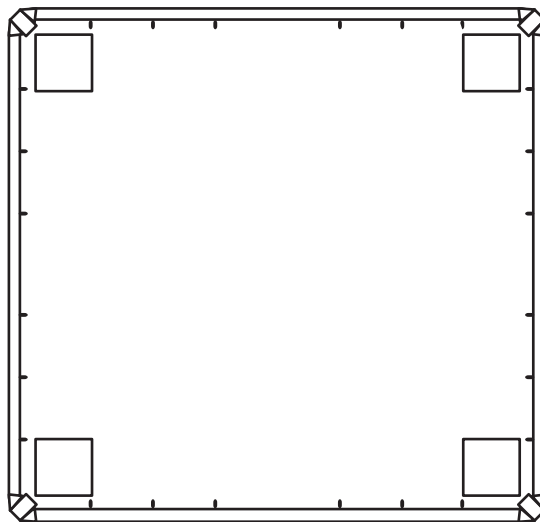
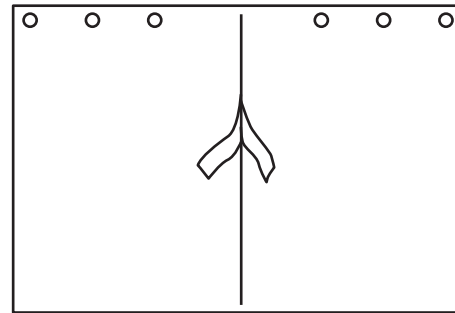
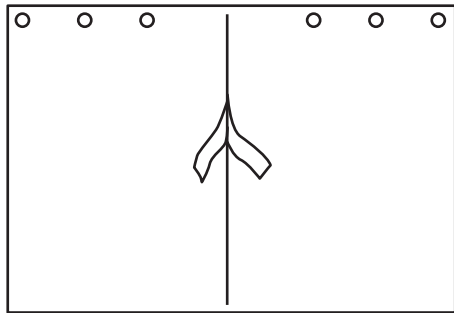
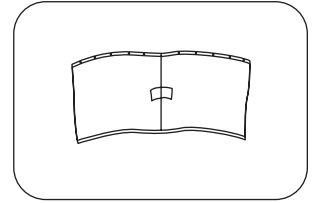

 **GG-L1-Q1 4 m x 4 m**

22

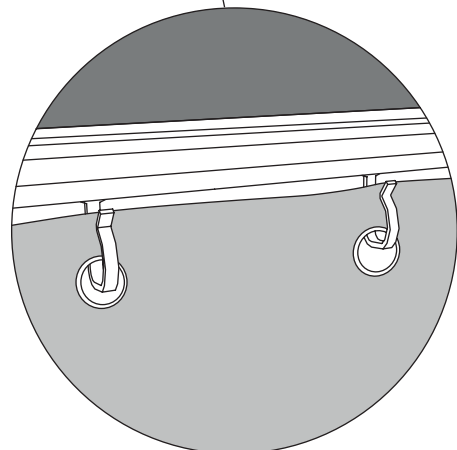
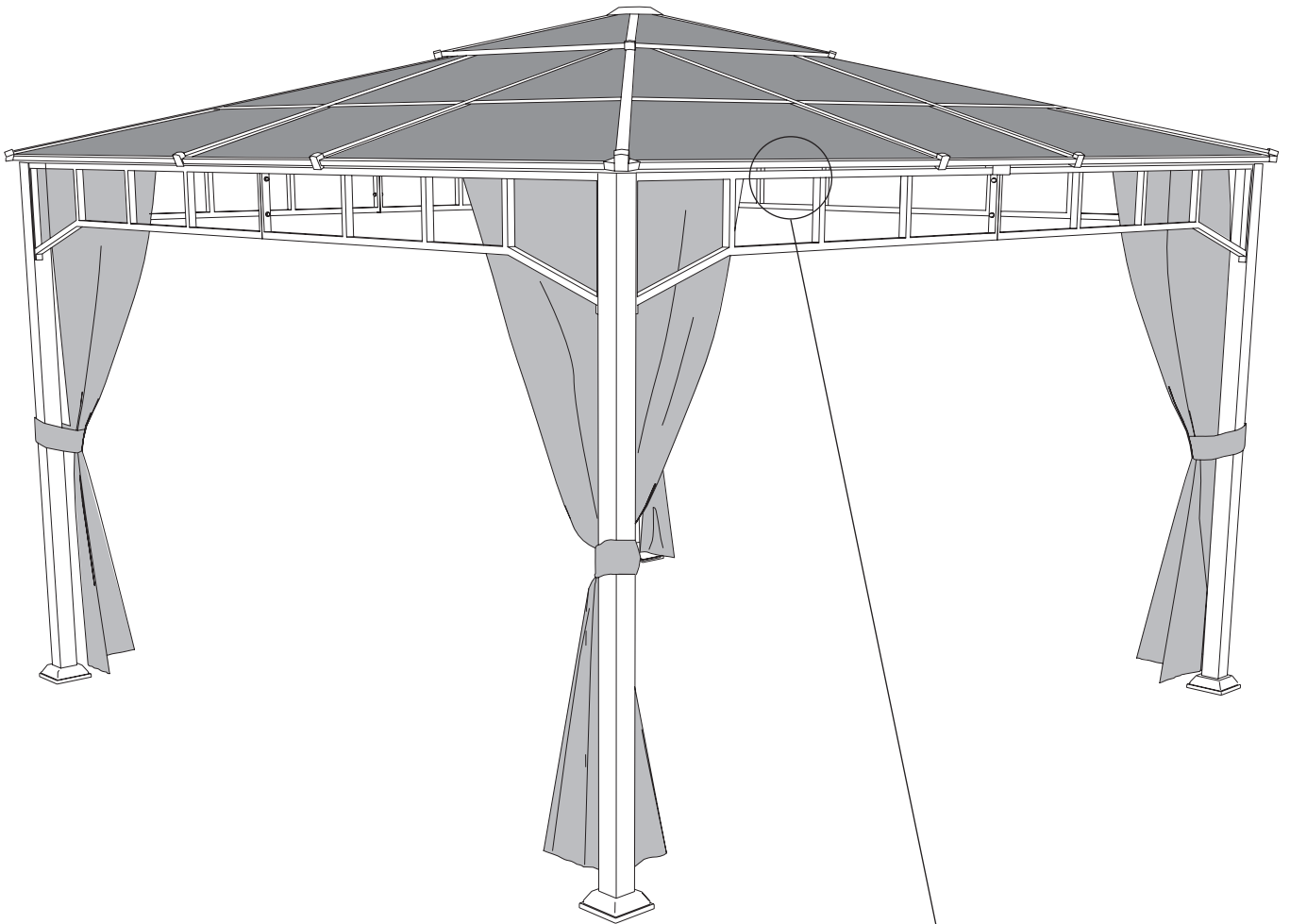
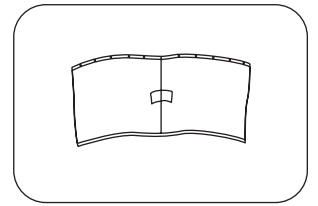

 **GG-L1-Q1 4 m x 4 m**

23

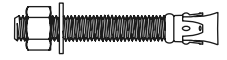

35137 M10 80 mm

