

 **GG-L1-Q2 4 m x 4 m**



07/2024-03

TOOLPORT

 **GG-L1-Q2 4 m x 4 m**

A

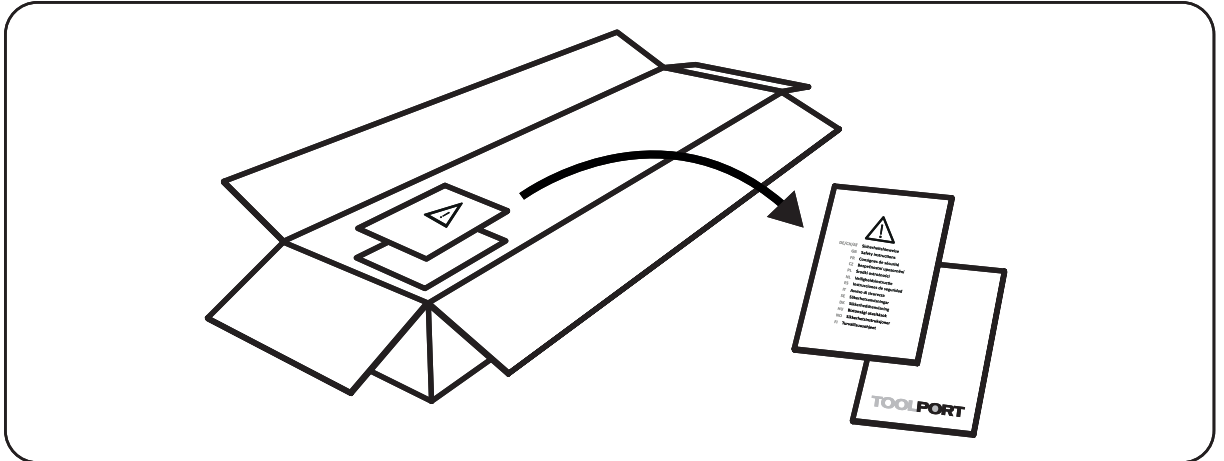



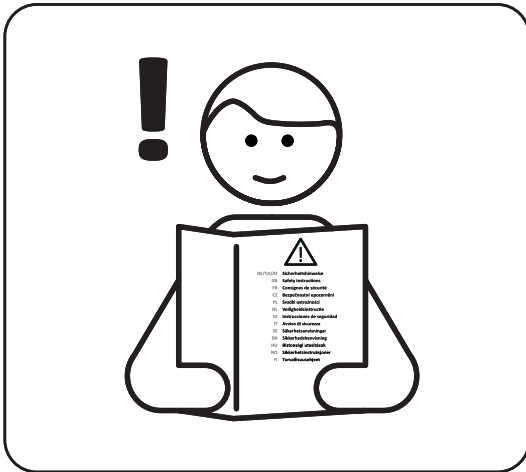



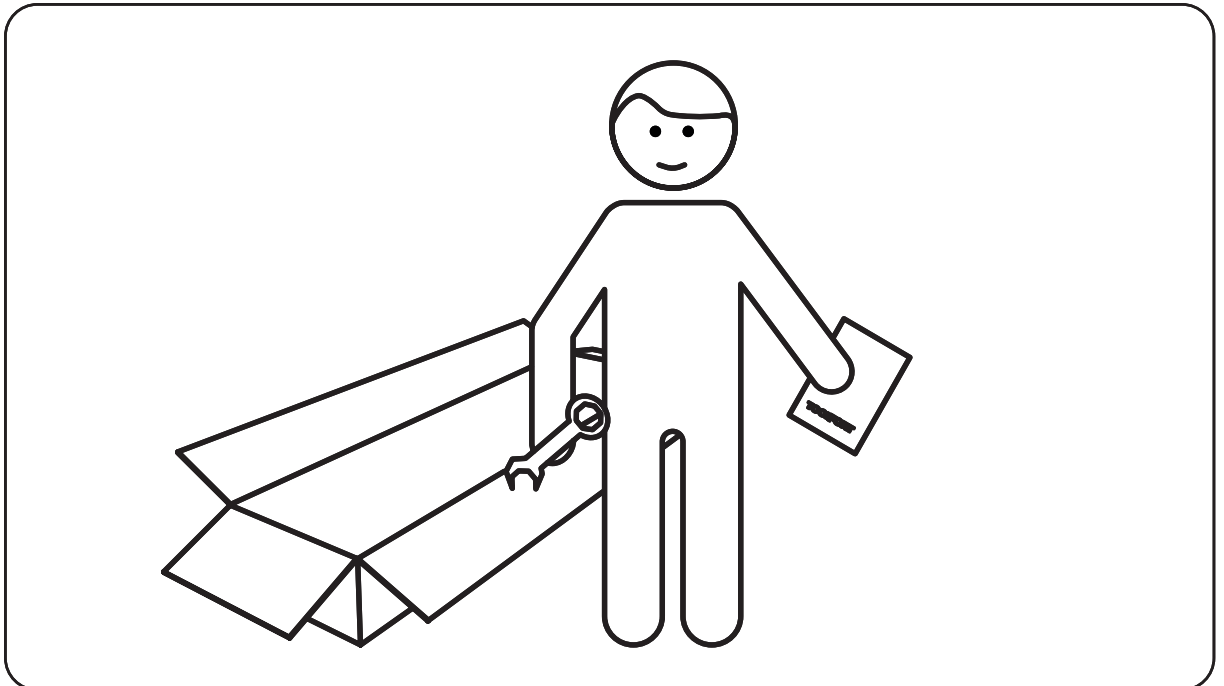





B



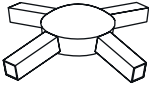







C

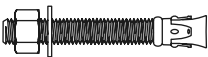

 **GG-L1-Q2 4 m x 4 m**

Item no.		Q'ty
39000		4
39003		4
39004		8
39005		4
39006		4
39007		1
39008		8
39002		4
39001		4
		4
		1

 **GG-L1-Q2 4 m x 4 m**

Item no.		Q'ty
35085	M6 15 mm 	8
39009	M6 25 mm 	8
39010	M6 28 mm 	16
39011	M6 32 mm 	12
35137	M10 80 mm 	8
35144		2
35145		1
35088		20
35086		64

 **GG-L1-Q2 4 m x 4 m**

1

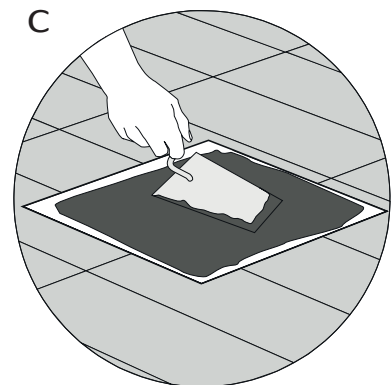
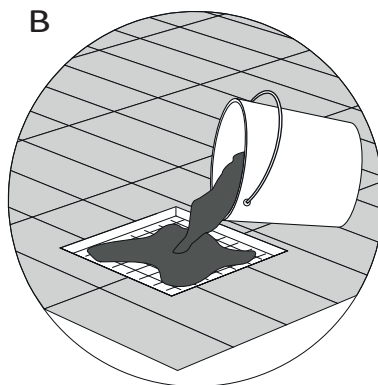
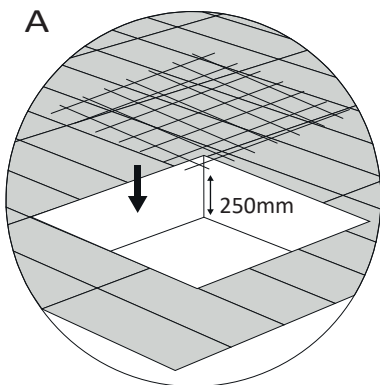
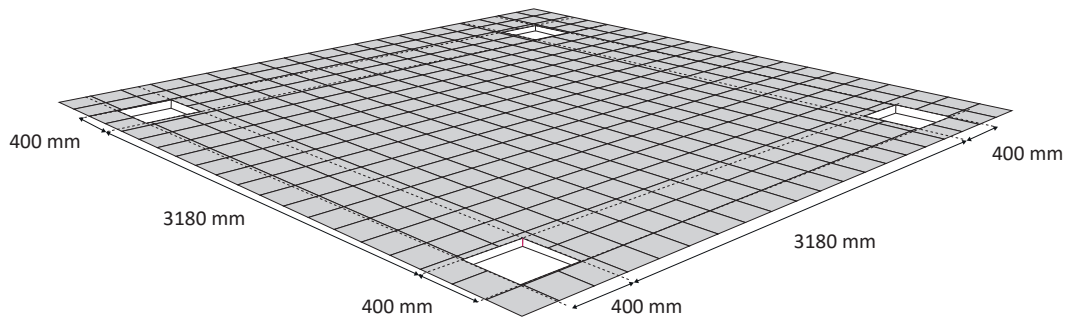
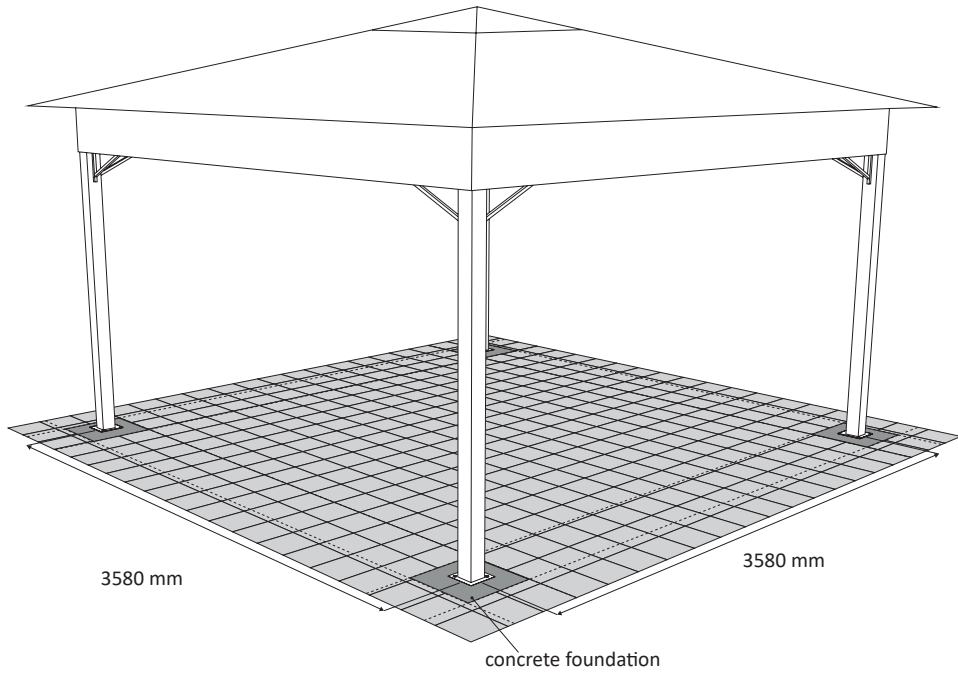

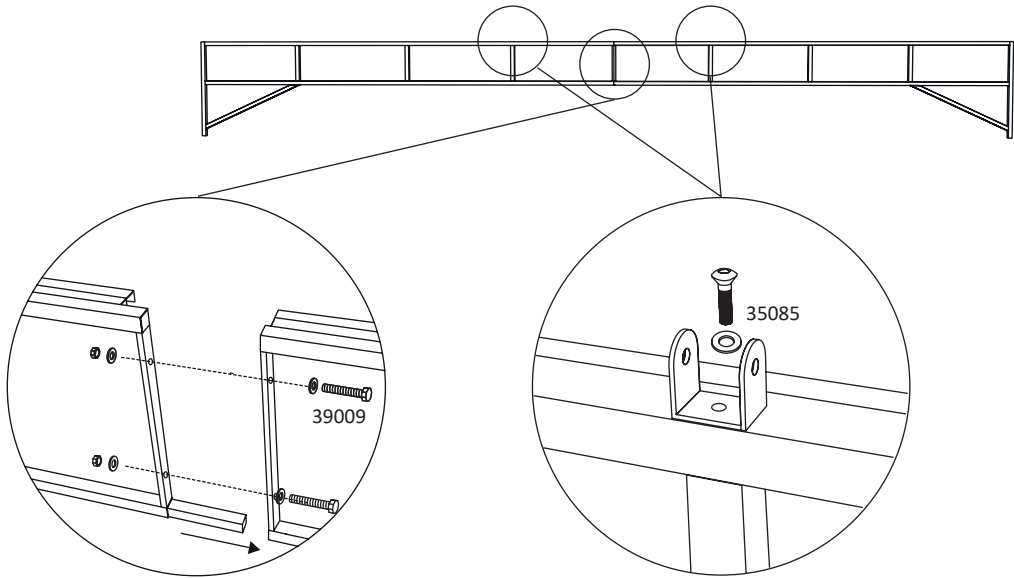
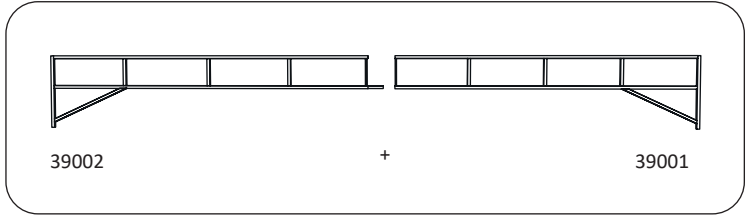
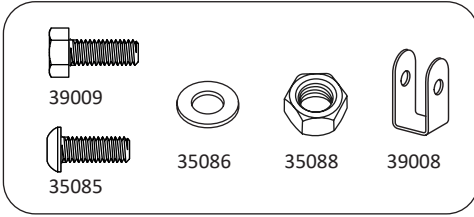

 **GG-L1-Q2 4 m x 4 m**

2

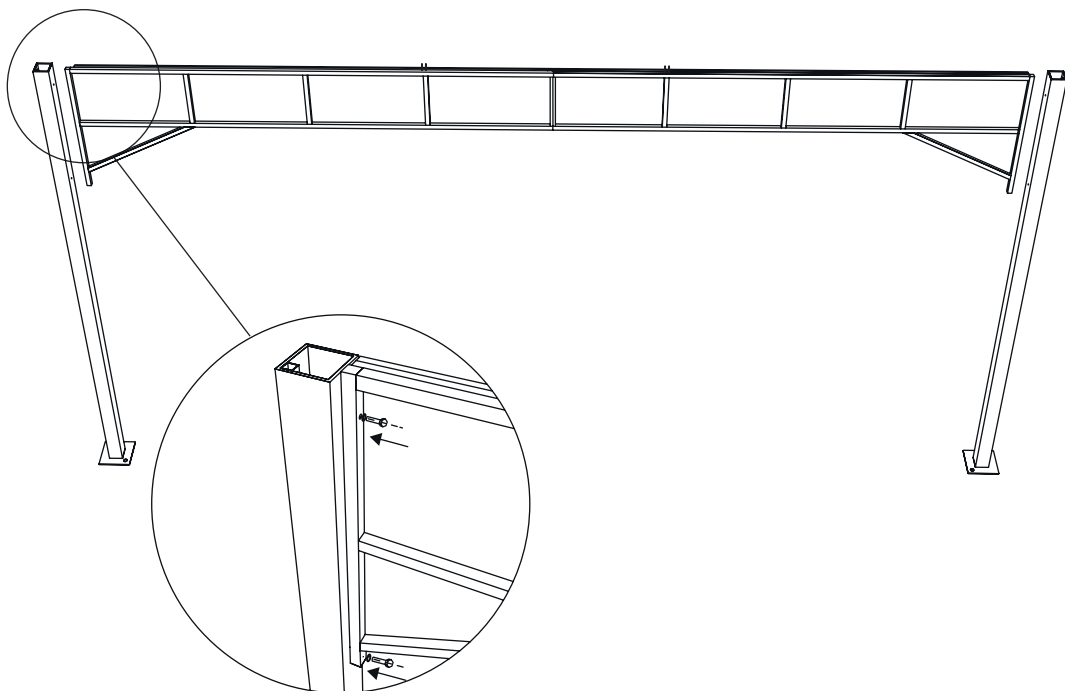
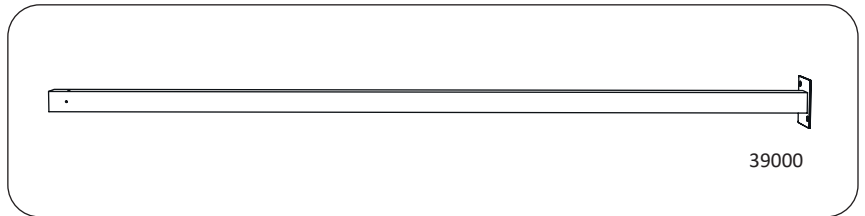
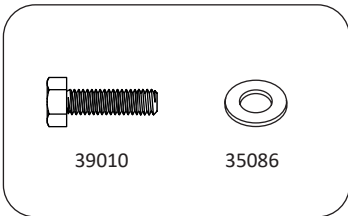

3



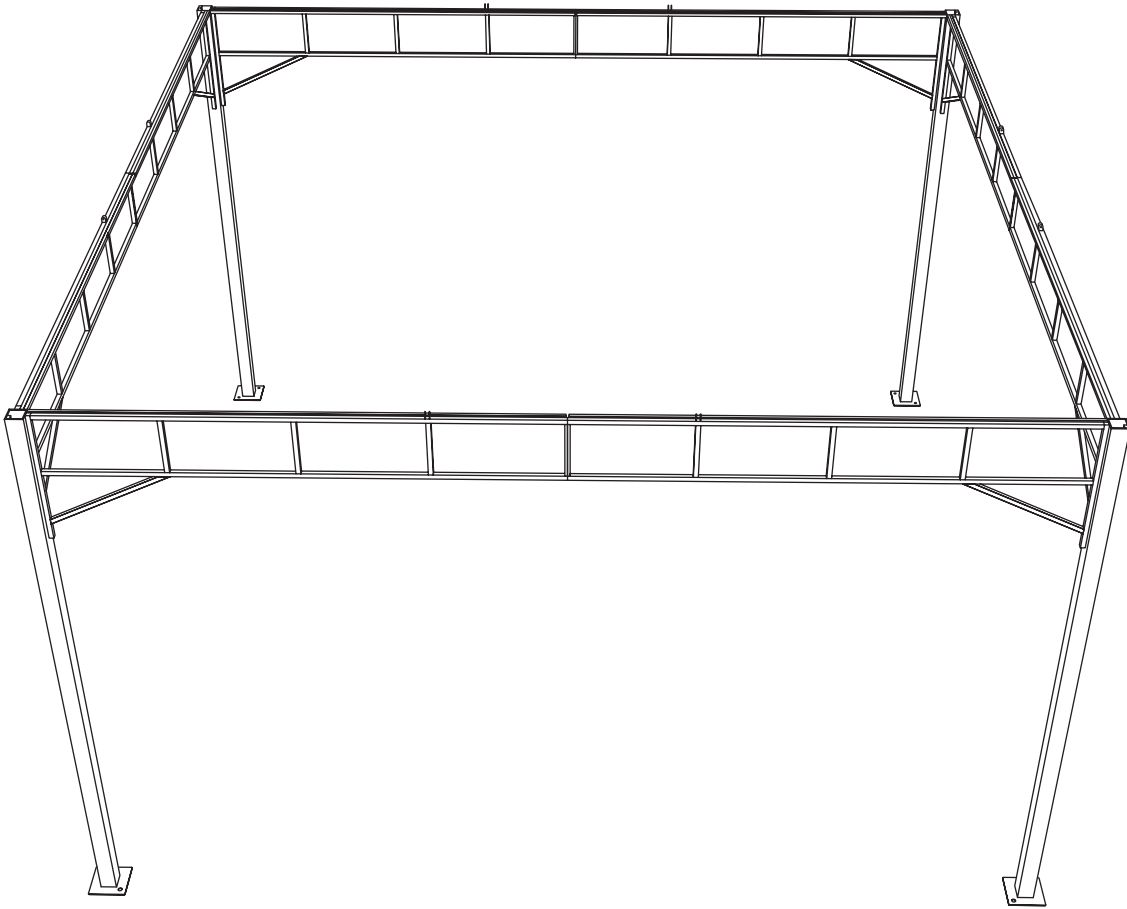

 **GG-L1-Q2 4 m x 4 m**

4

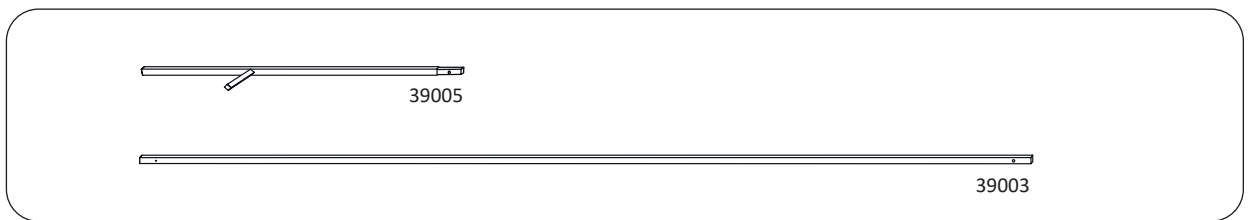

5



 **GG-L1-Q2 4 m x 4 m**

6

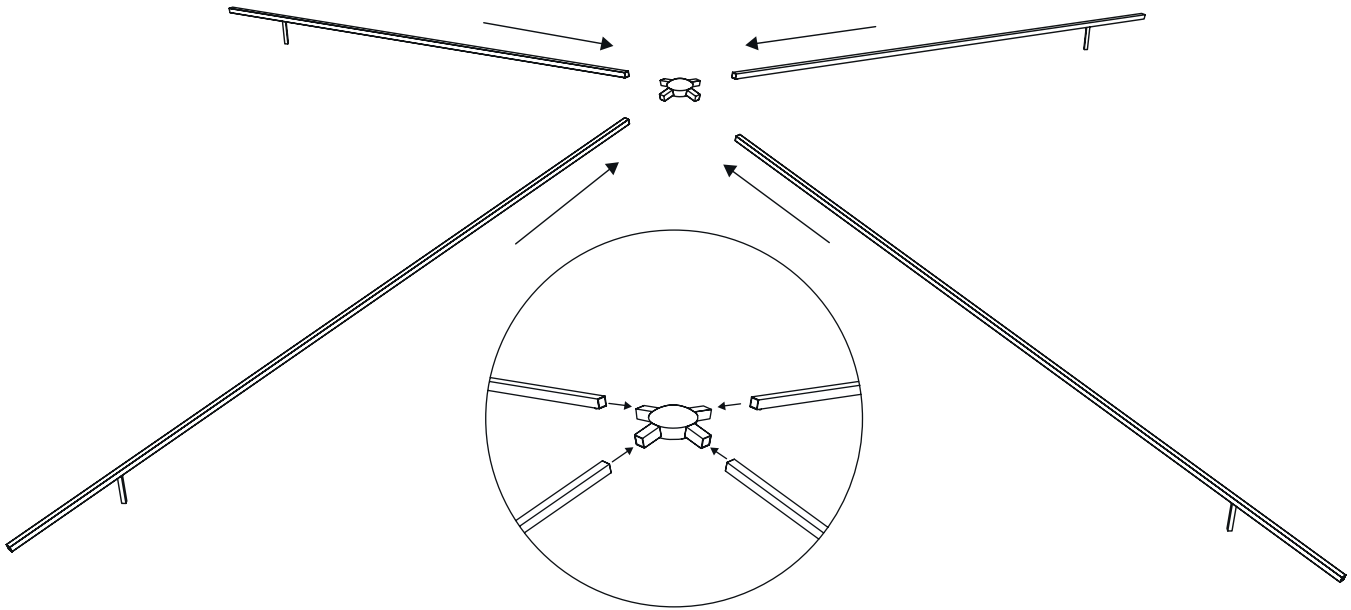
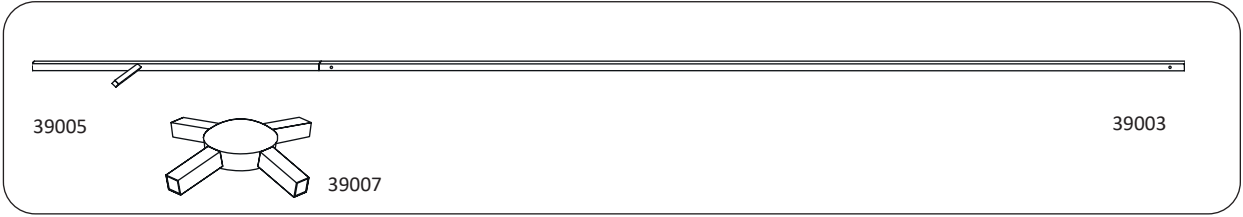

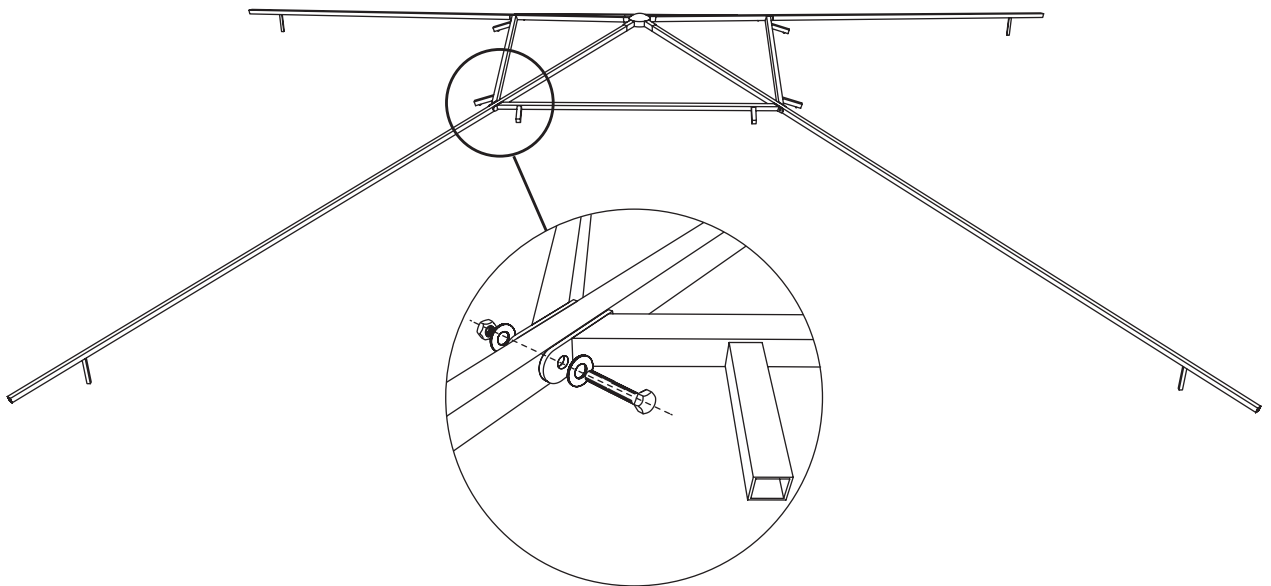
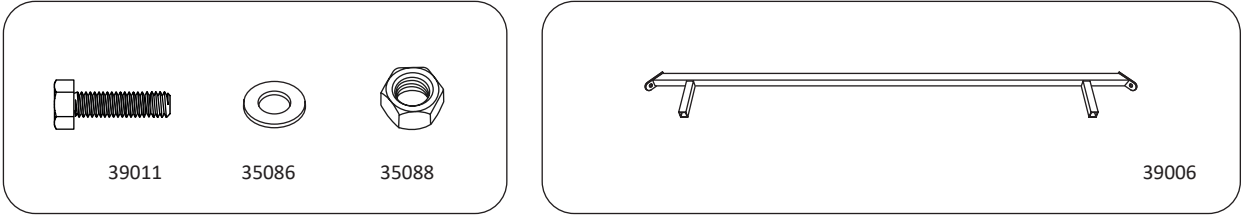

7

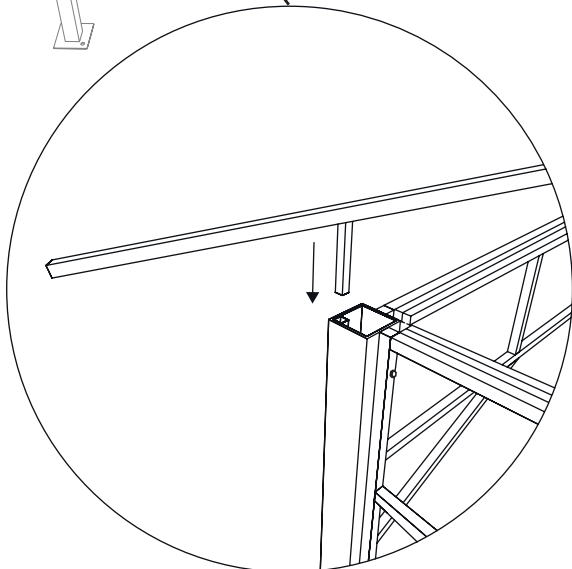
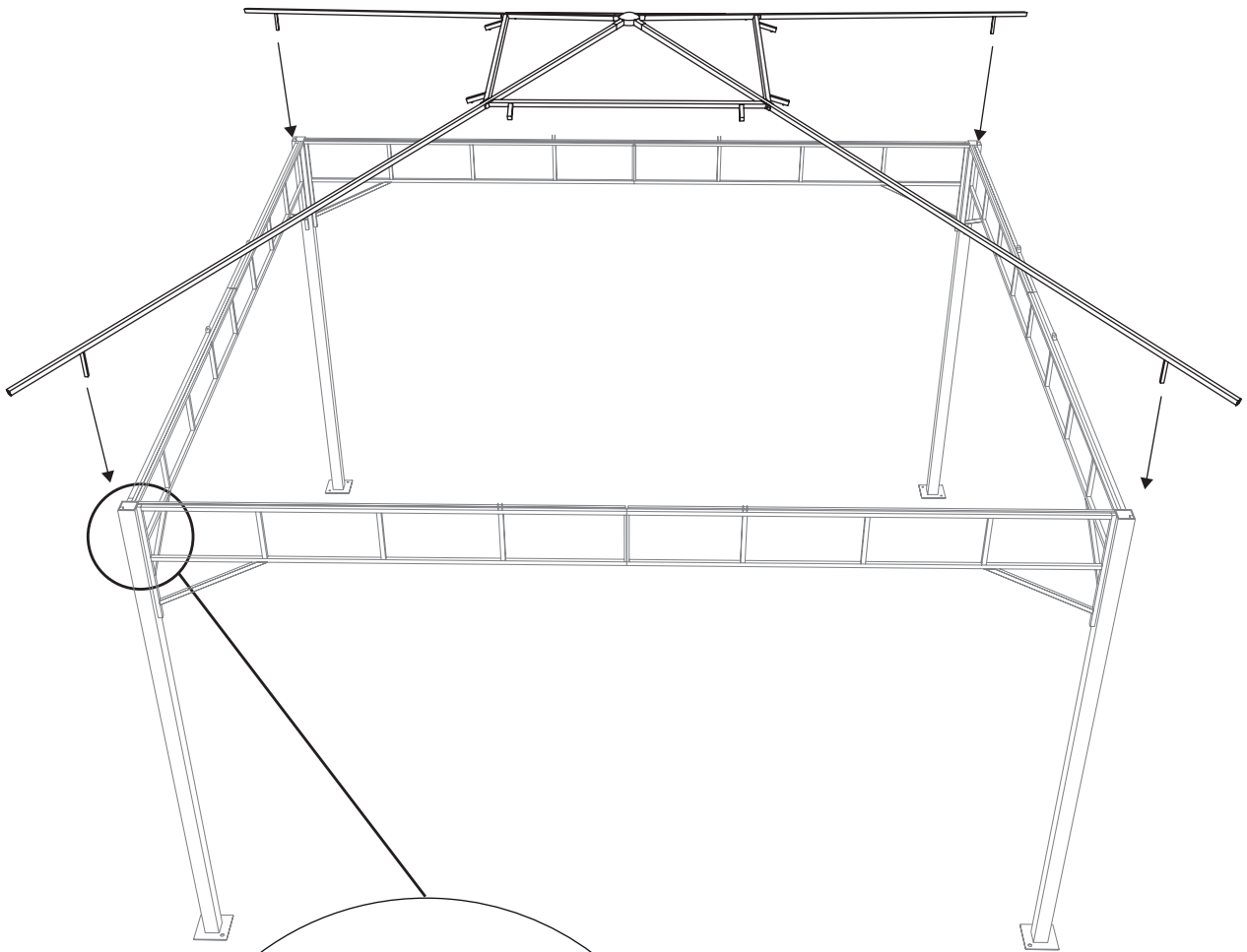

 **GG-L1-Q2 4 m x 4 m**

8



 **GG-L1-Q2 4 m x 4 m**

9

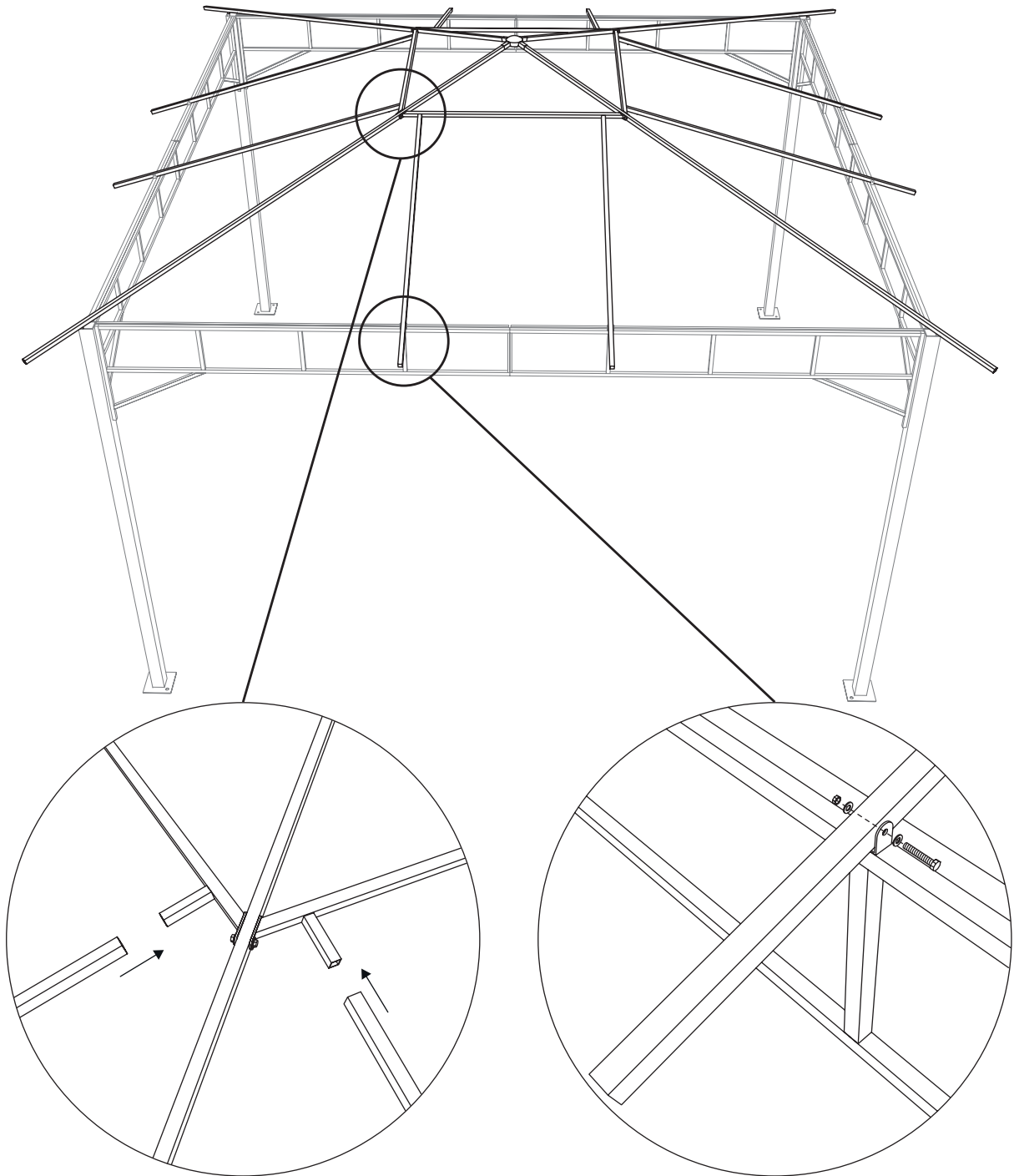
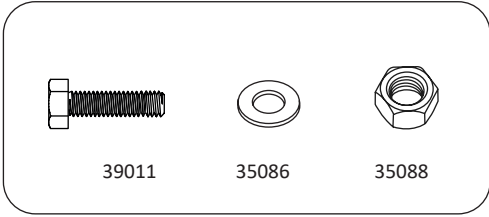

 **GG-L1-Q2 4 m x 4 m**

10

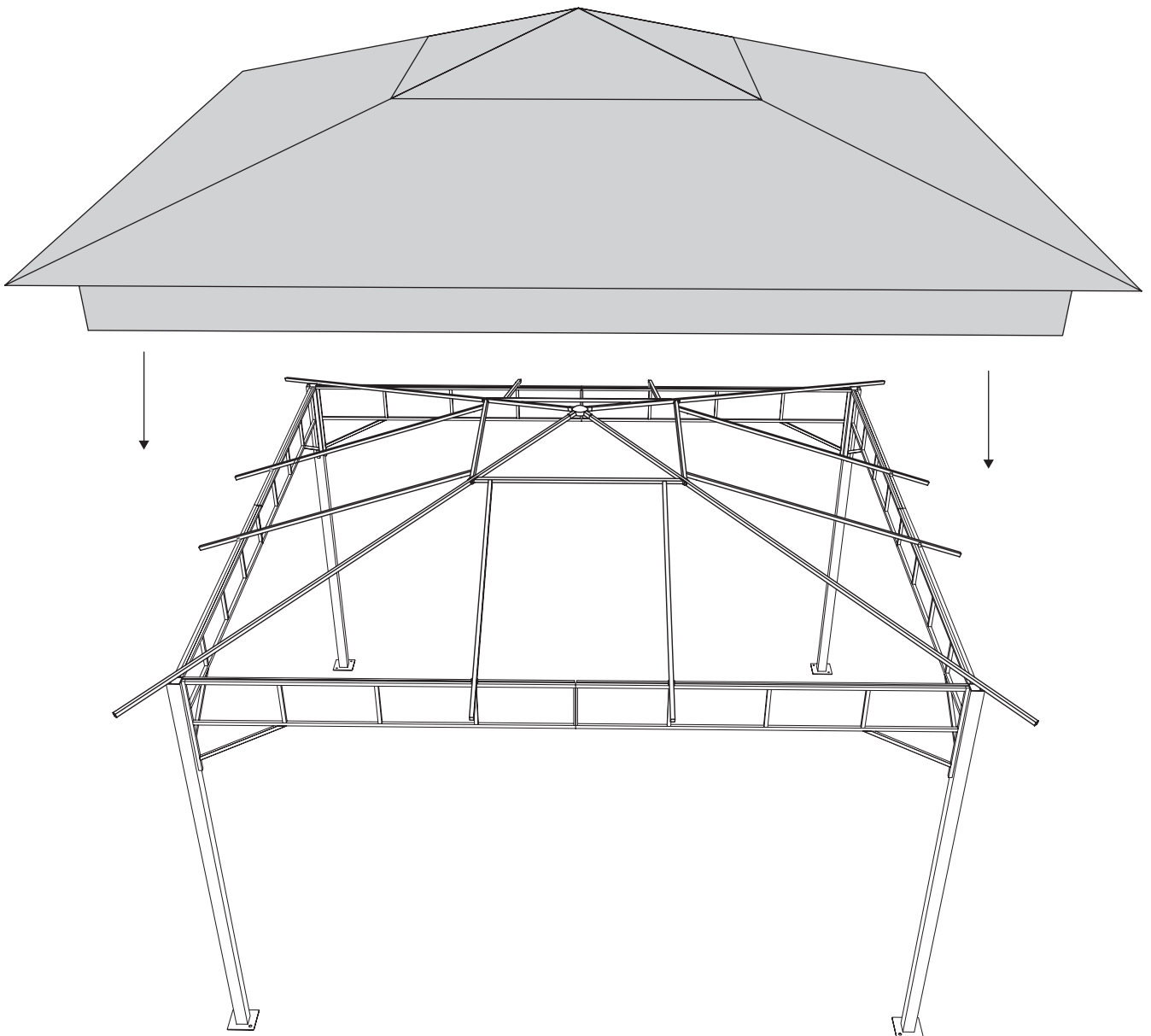
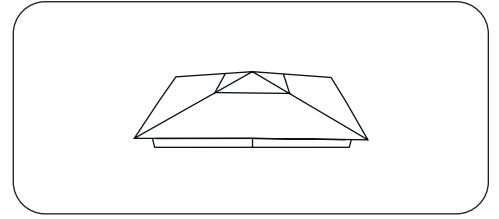

 **GG-L1-Q2 4 m x 4 m**

11

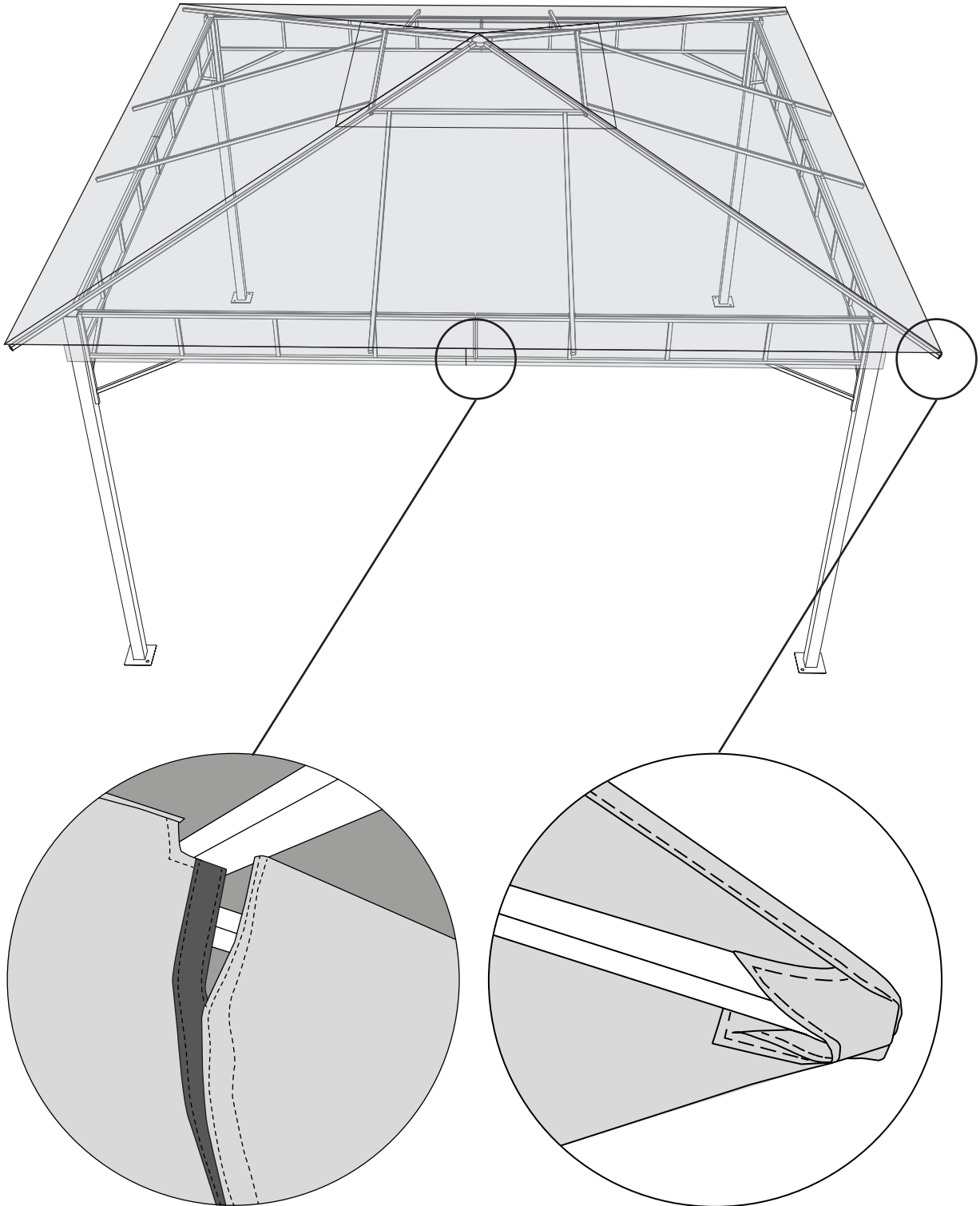

 **GG-L1-Q2 4 m x 4 m**

12

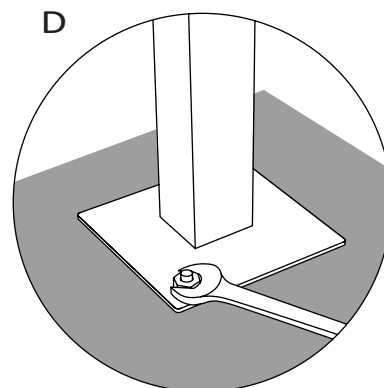
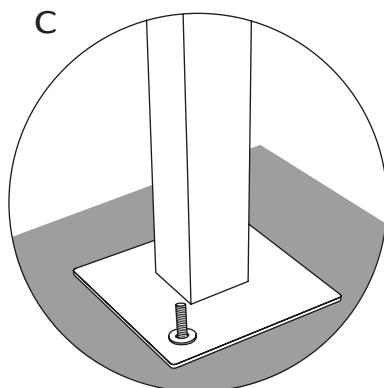
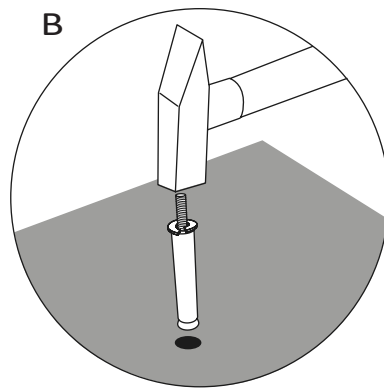
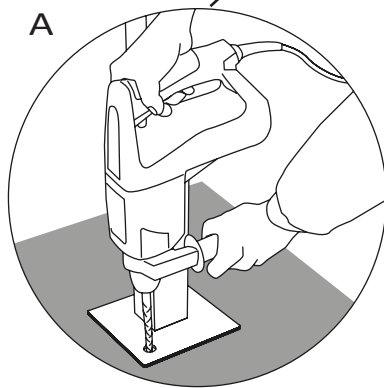
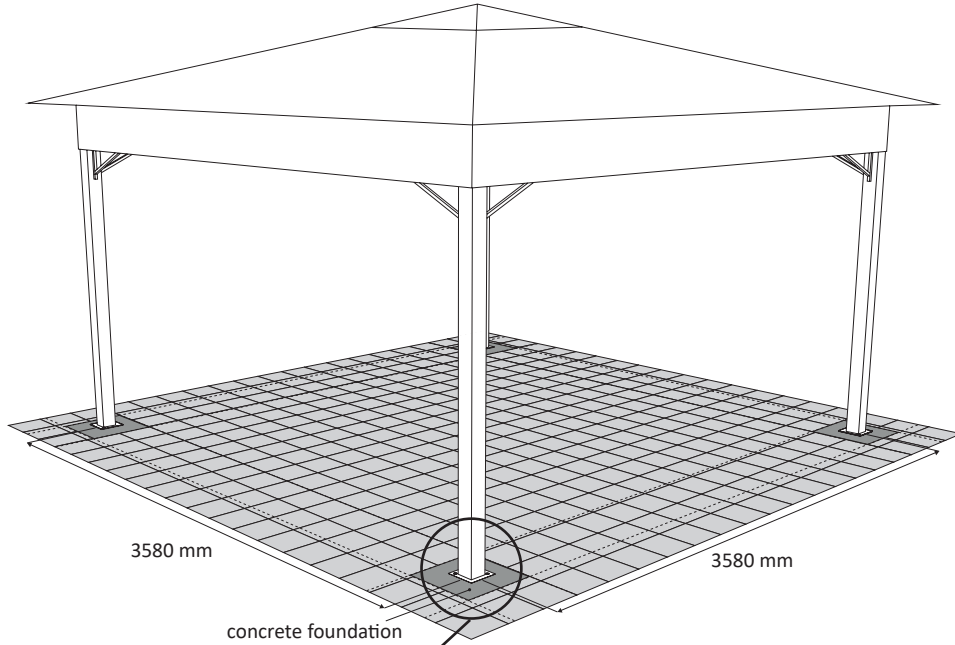
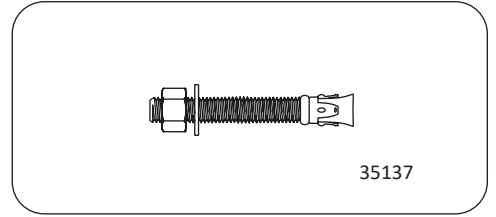

 **GG-L1-Q2** 4 m x 4 m

13

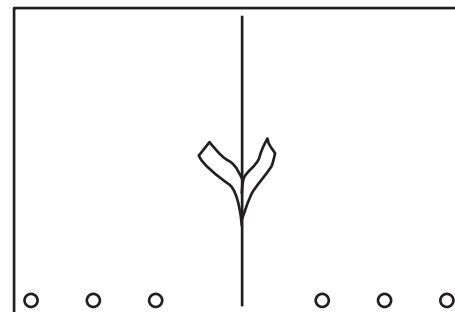
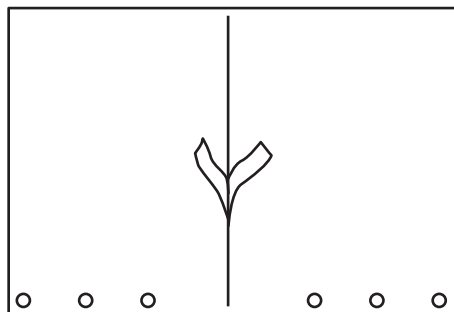
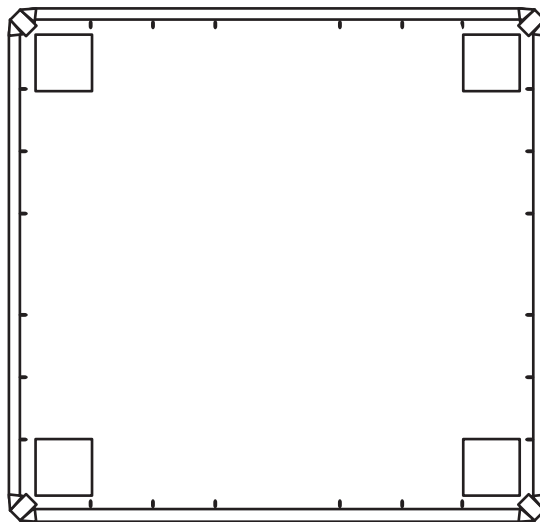
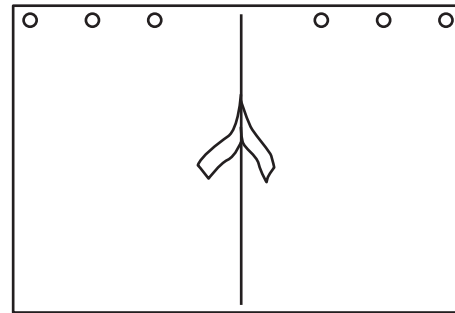
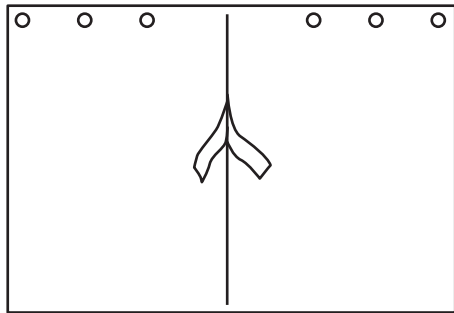
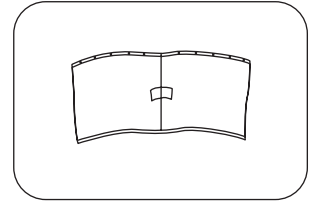

 **GG-L1-Q2 4 m x 4 m**

14

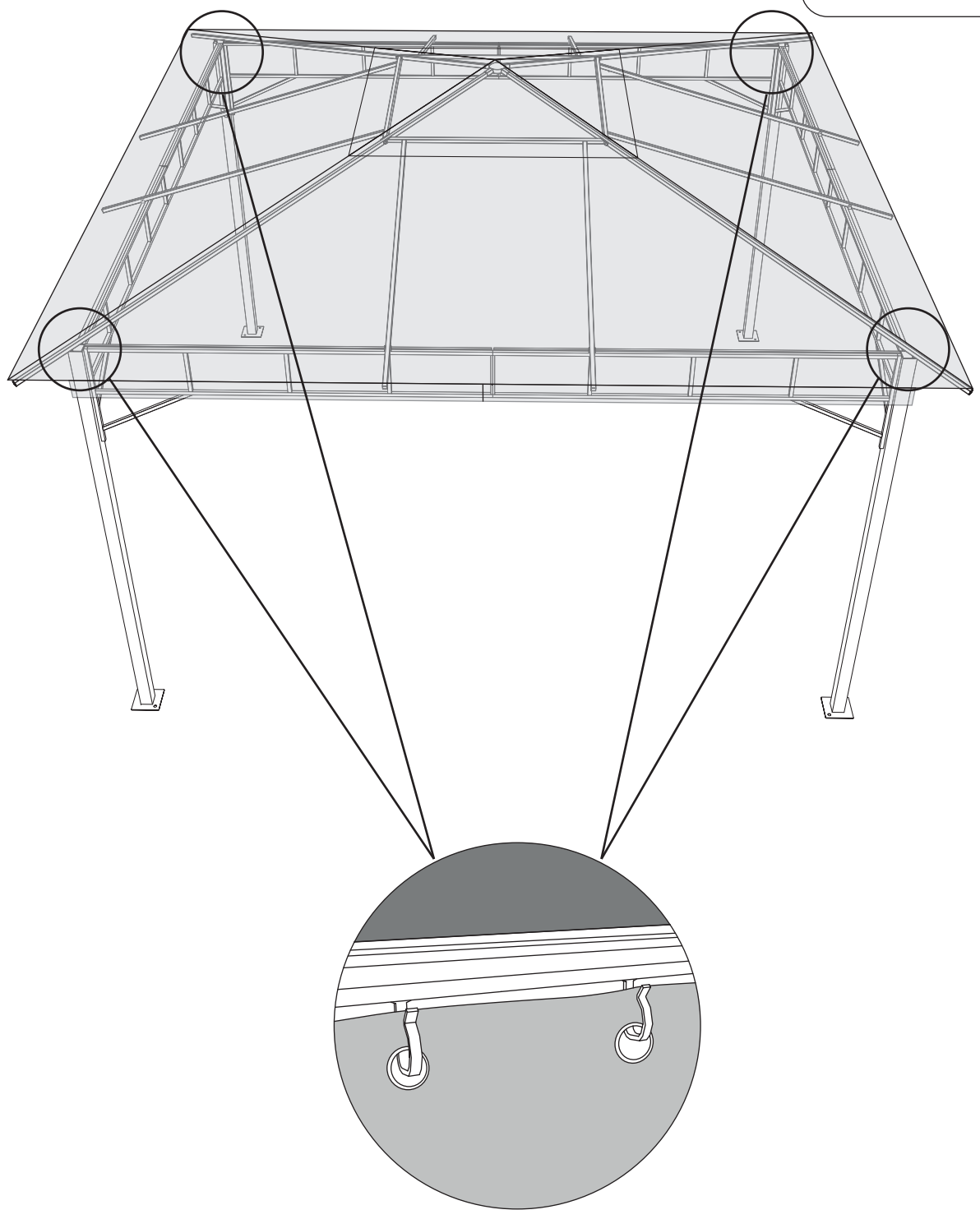
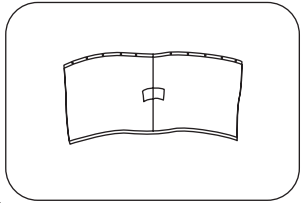

 **GG-L1-Q2 4 m x 4 m**

