 **GG-L1-Q3** 3 m x 3 m



07/2024-05

TOOLPORT

 **GG-L1-Q3 3 m x 3 m**

A

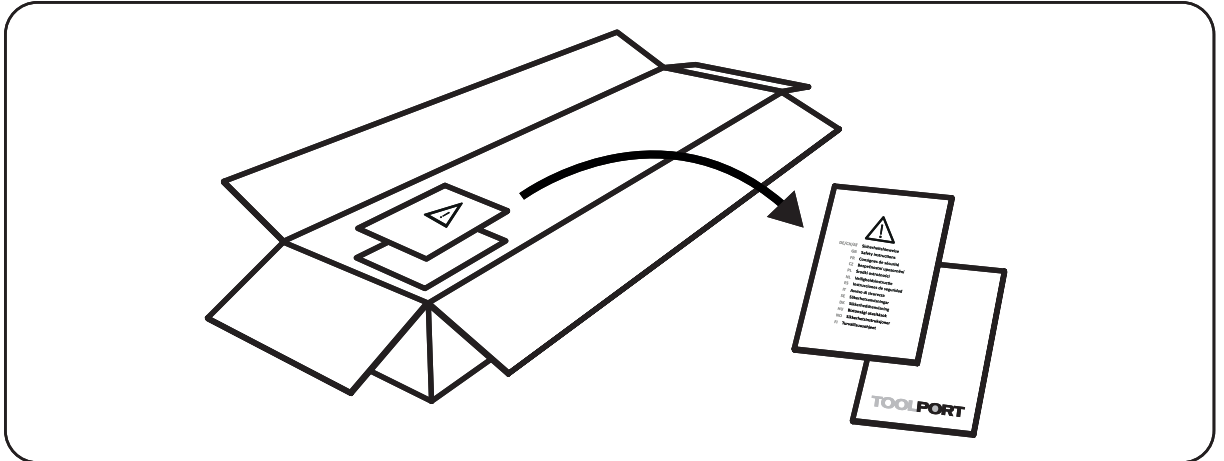



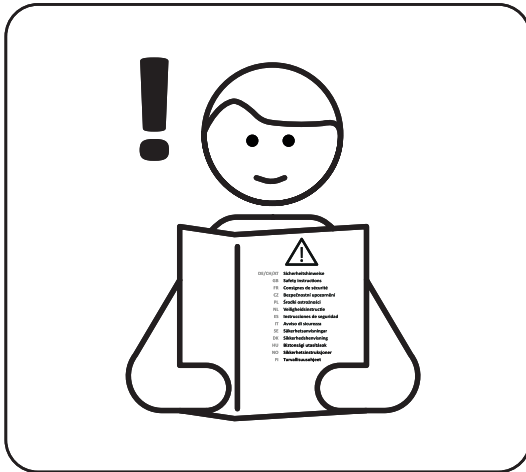

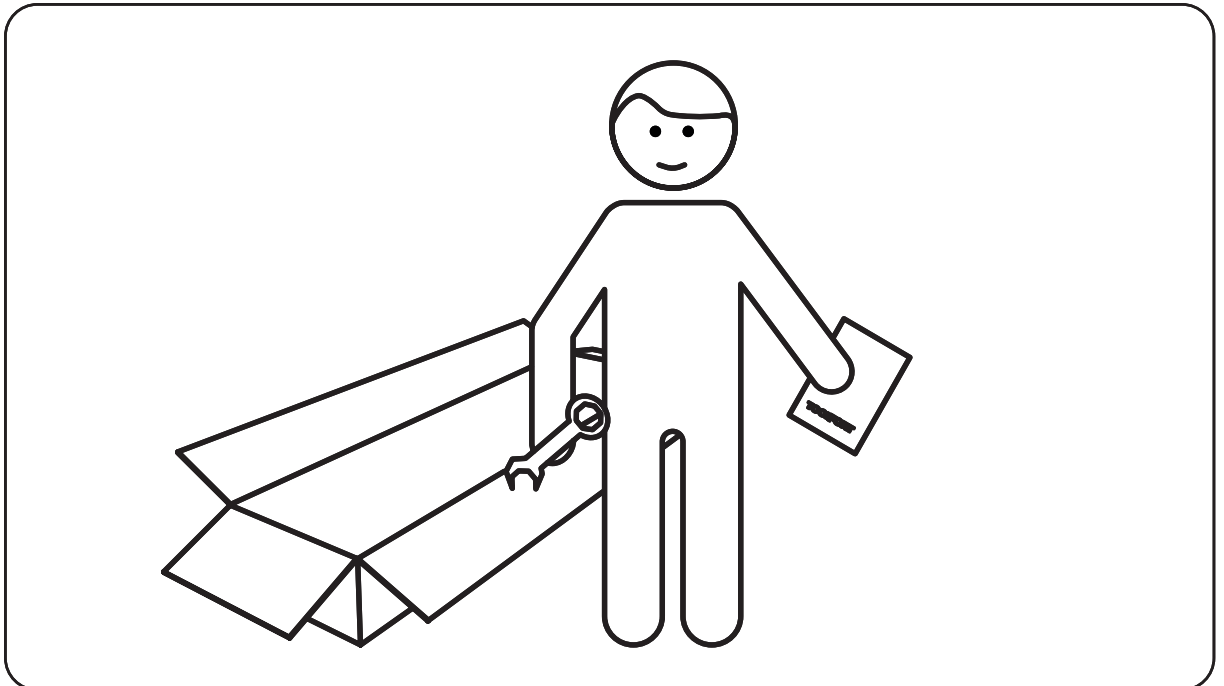

B

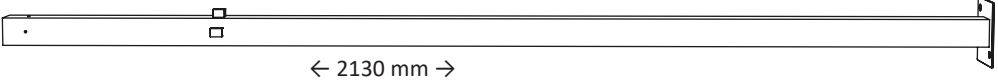

C

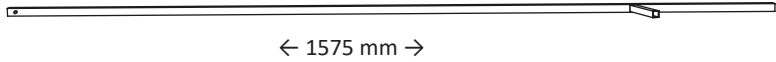
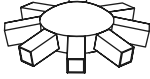
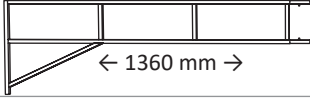
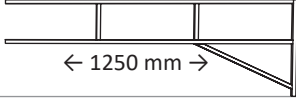
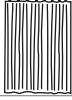
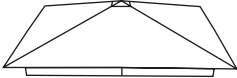

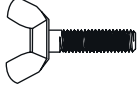

 **GG-L1-Q3 3 m x 3 m**

Item no.		Q'ty
35098		4
35000		4
35001		4
35002		1
35003		4
35004		4
		4
		1
35091		32
35090		8
35086		8
35137		8

 **GG-L1-Q3 3 m x 3 m**

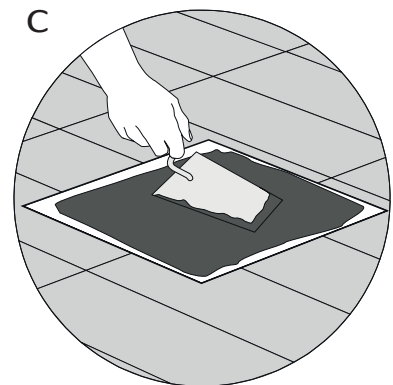
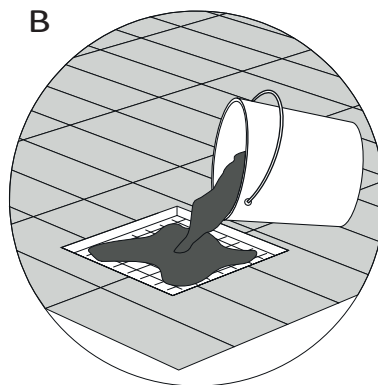
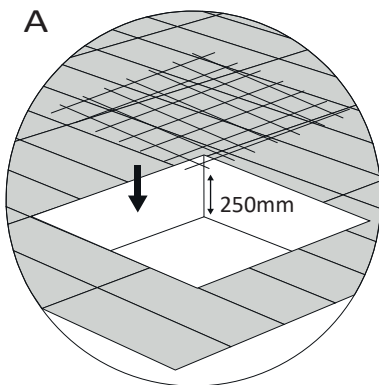
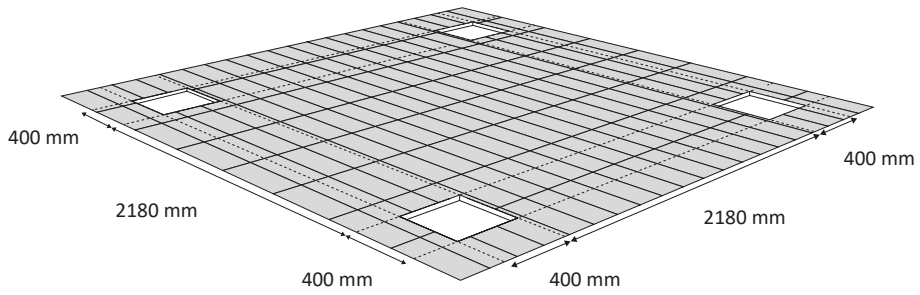
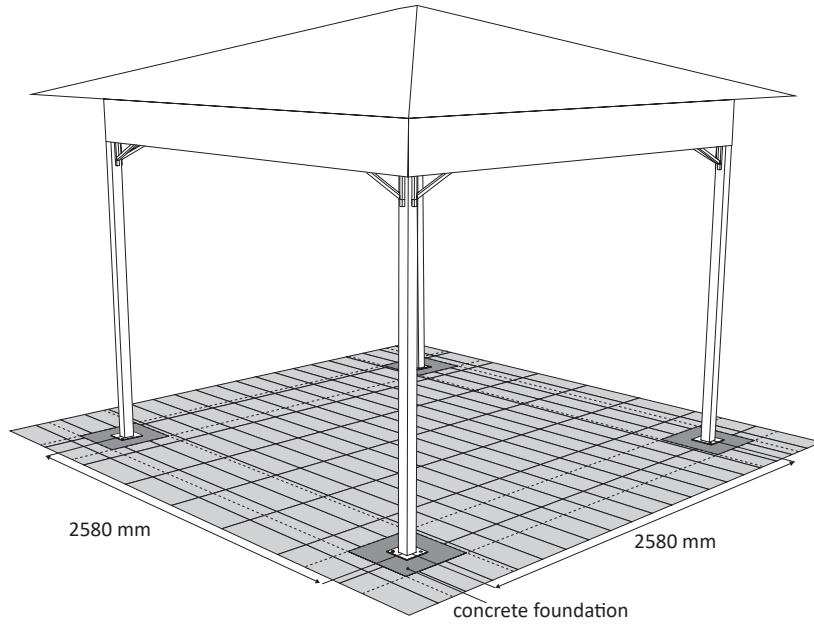
1



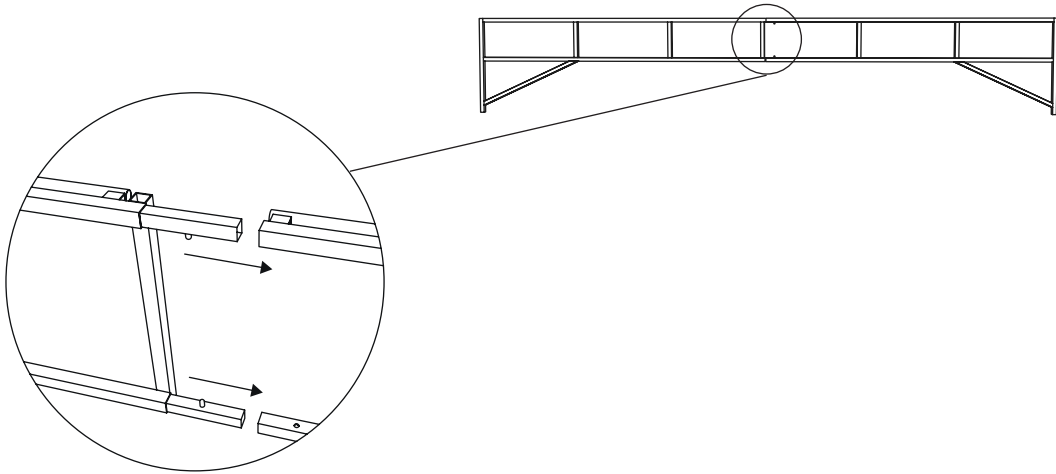
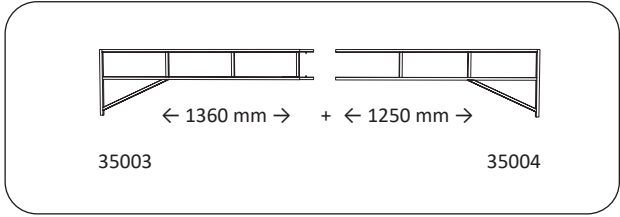

 **GG-L1-Q3 3 m x 3 m**

2



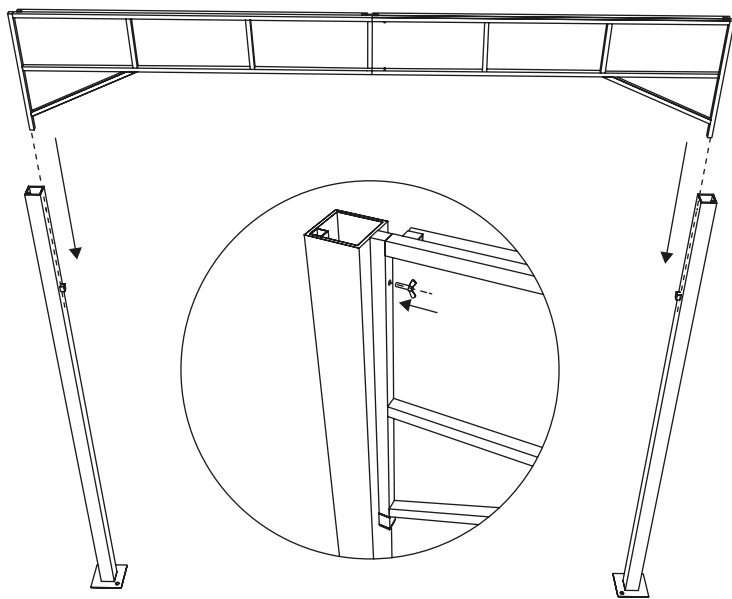
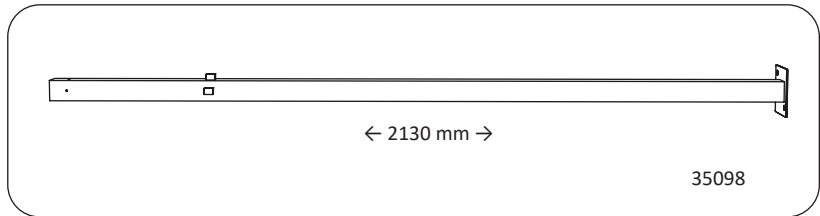
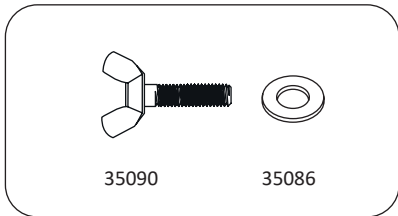

3

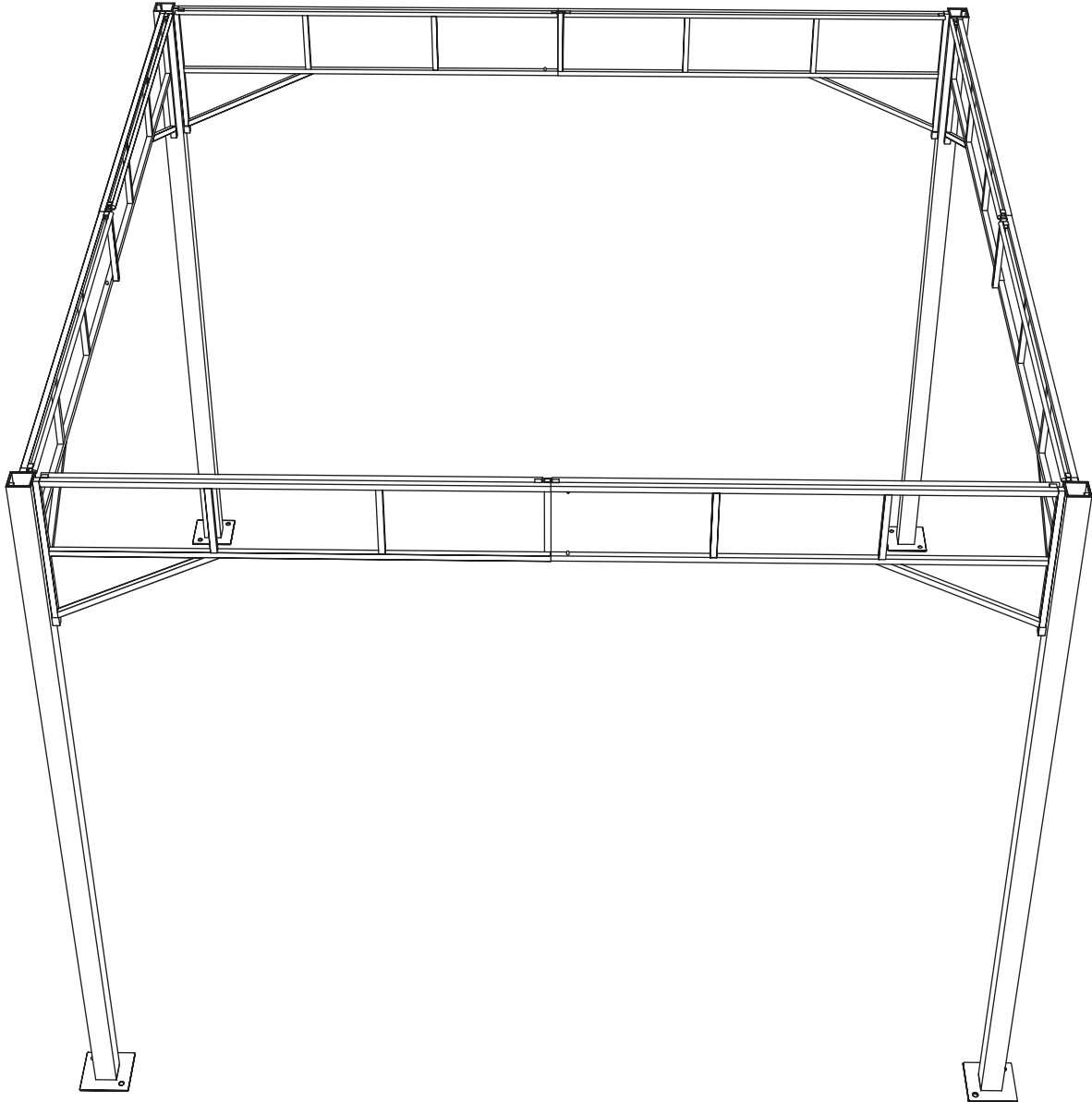

 **GG-L1-Q3 3 m x 3 m**

4



 **GG-L1-Q3 3 m x 3 m**

5

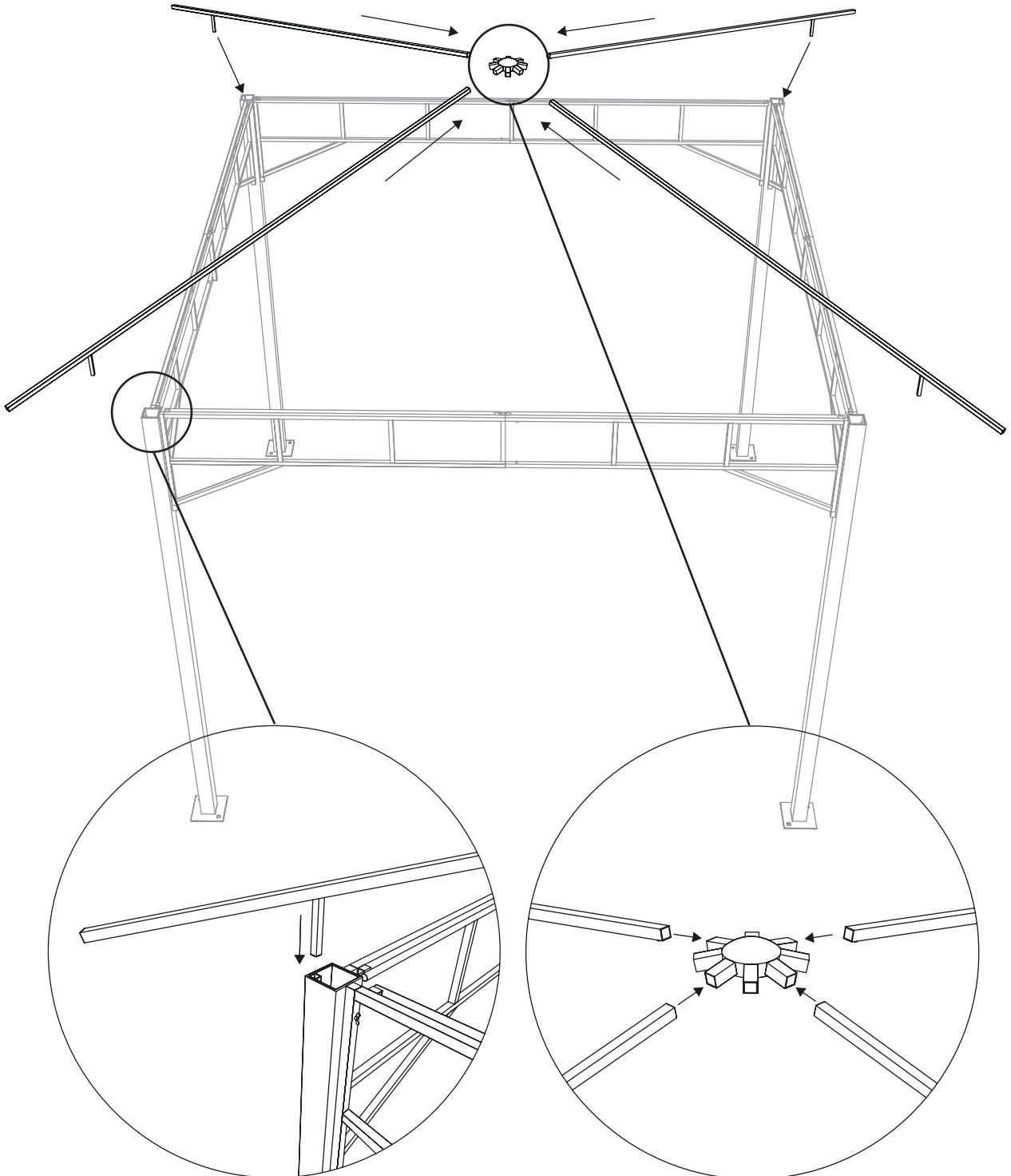
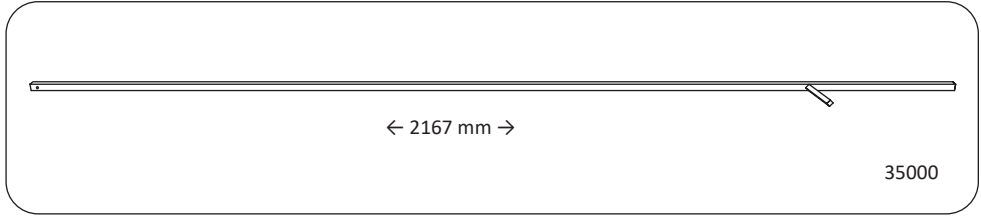
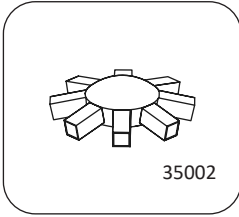

 **GG-L1-Q3 3 m x 3 m**

6

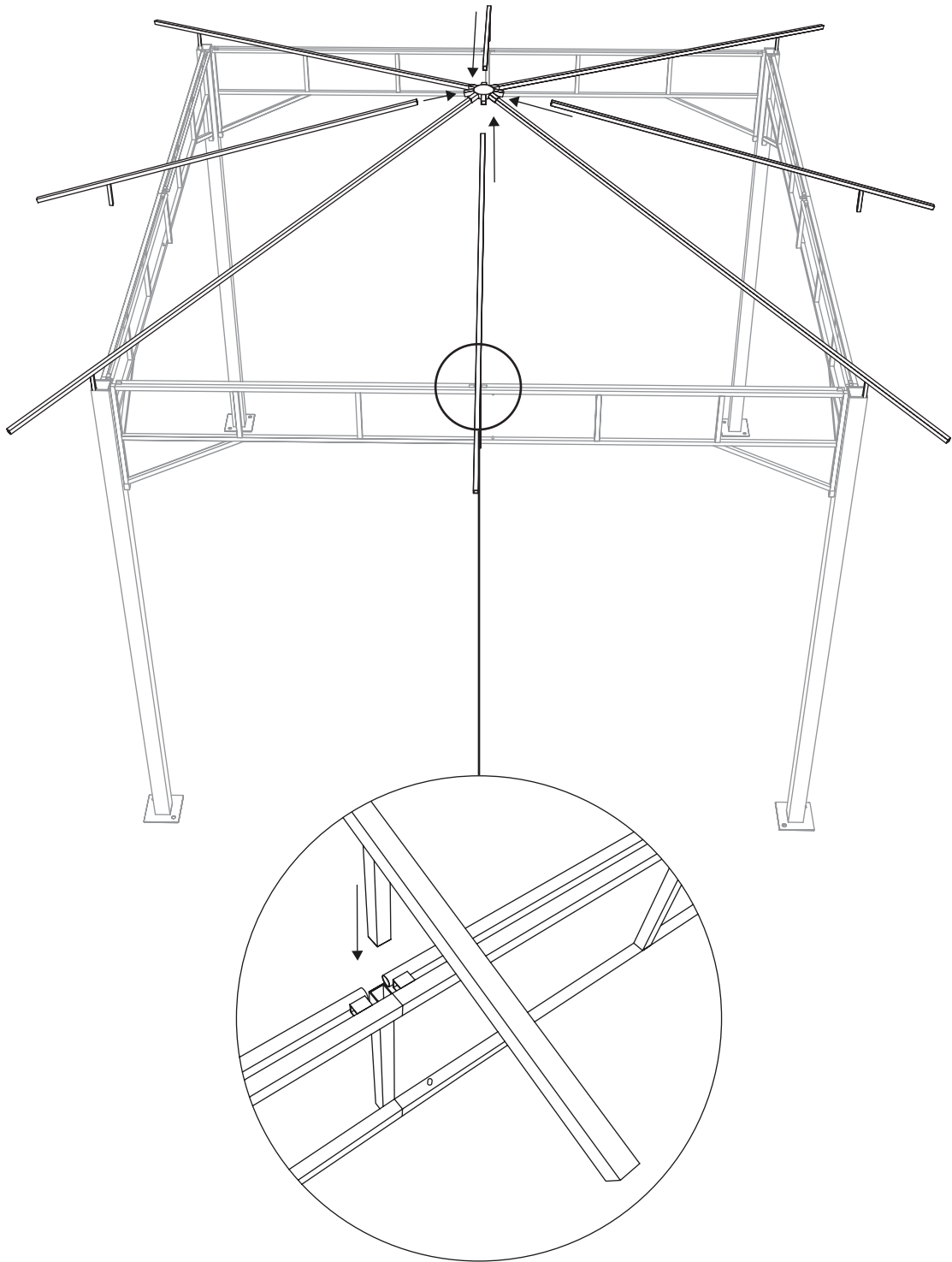
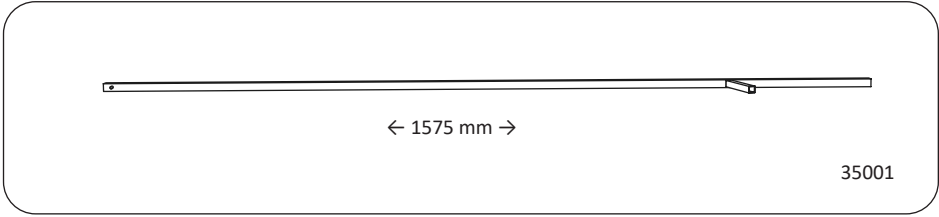

 **GG-L1-Q3 3 m x 3 m**

7

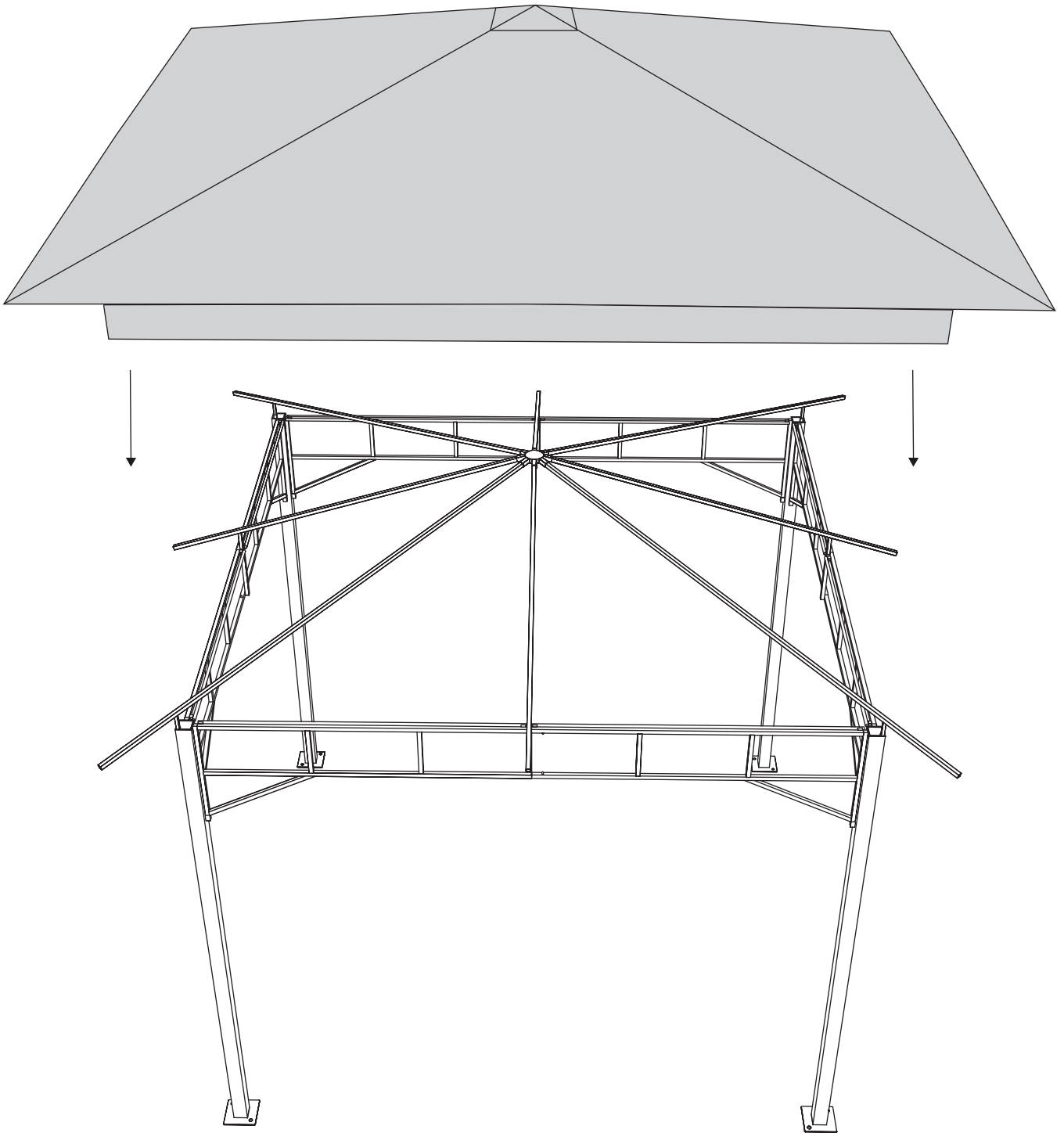
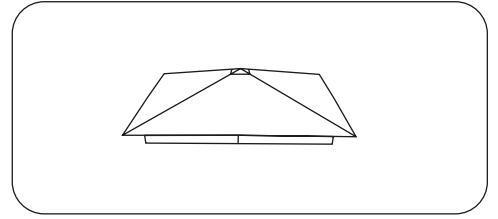

 **GG-L1-Q3 3 m x 3 m**

8

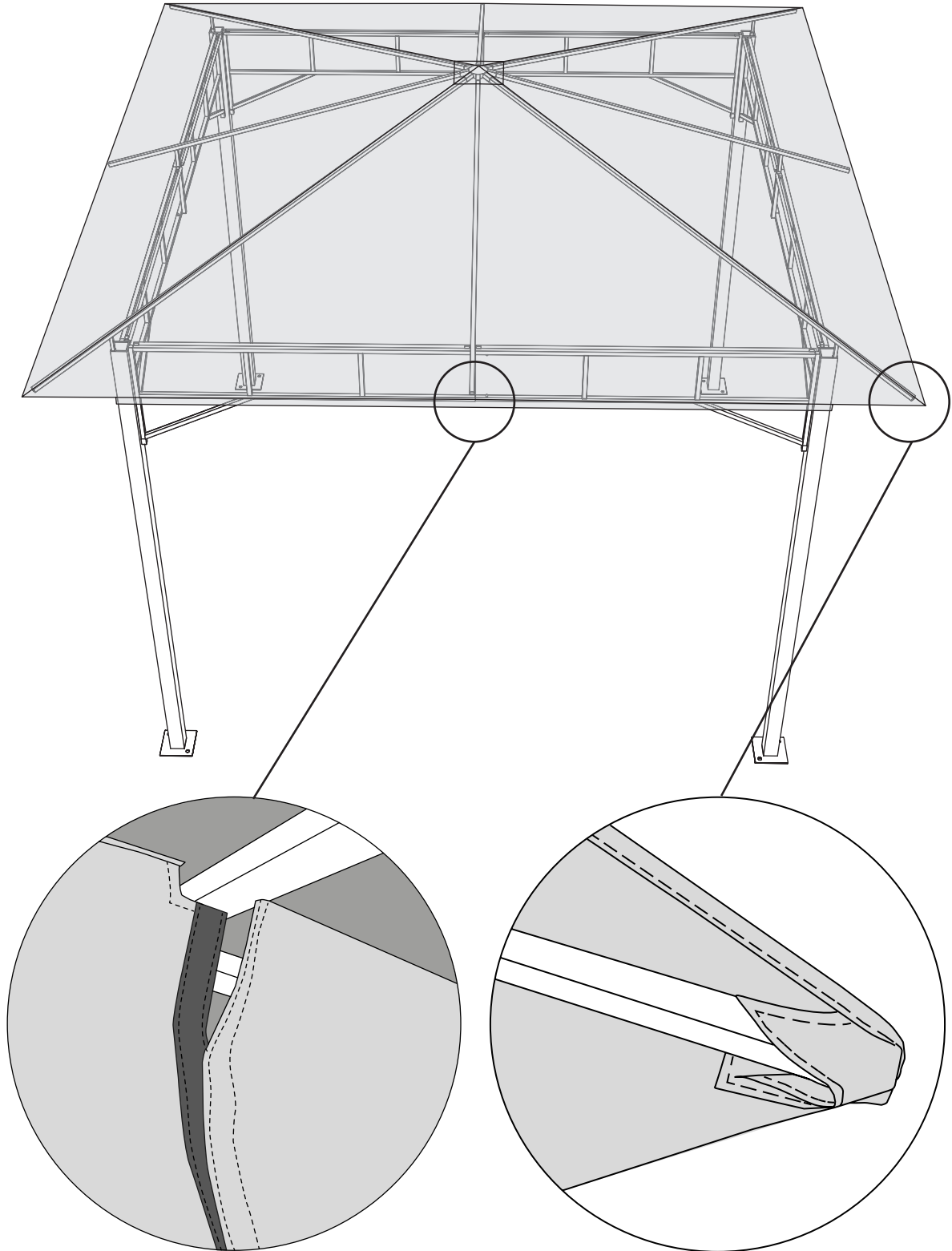

 **GG-L1-Q3 3 m x 3 m**

10

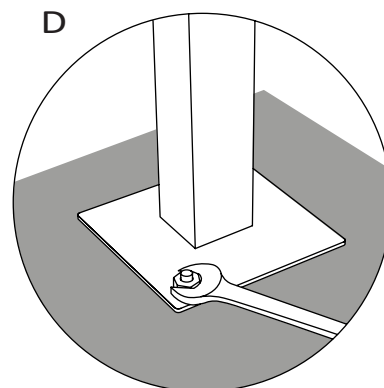
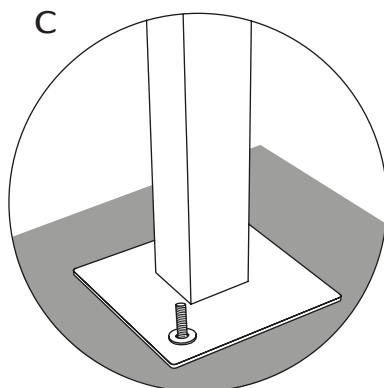
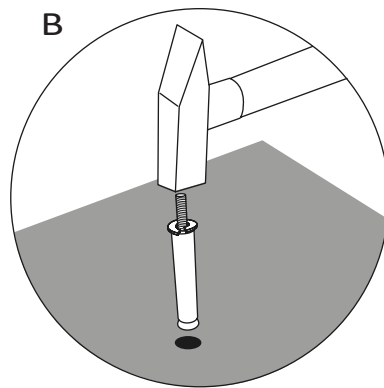
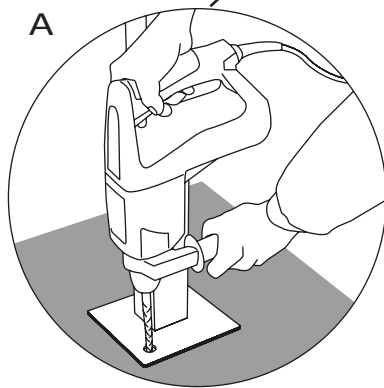
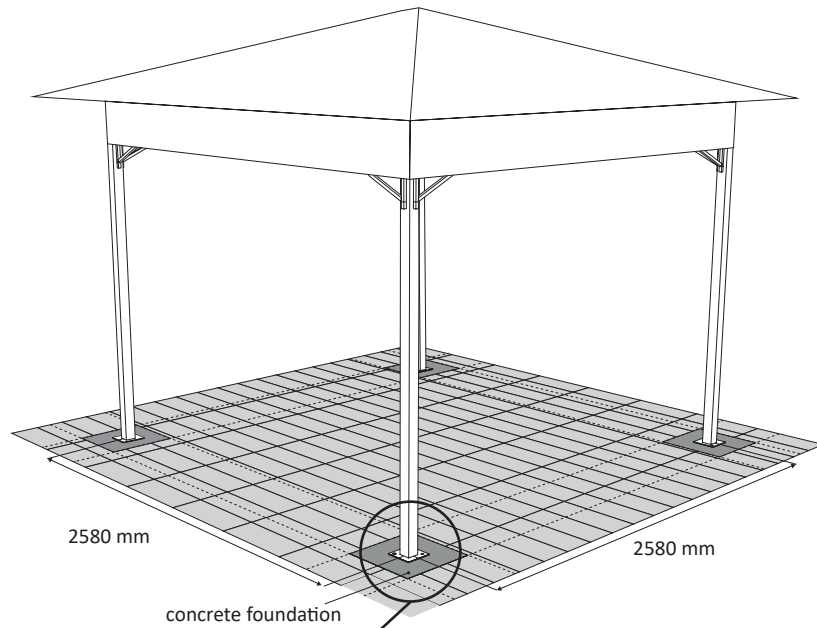
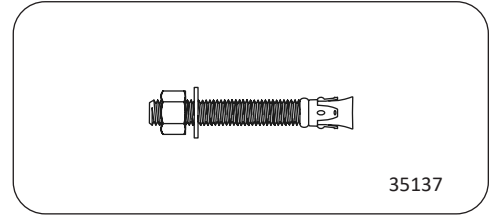

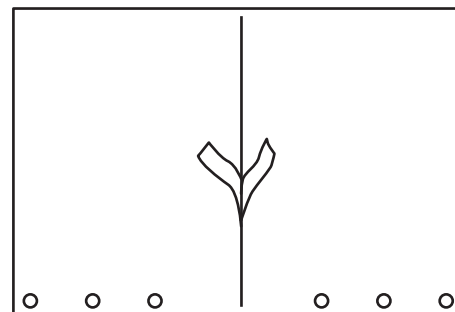
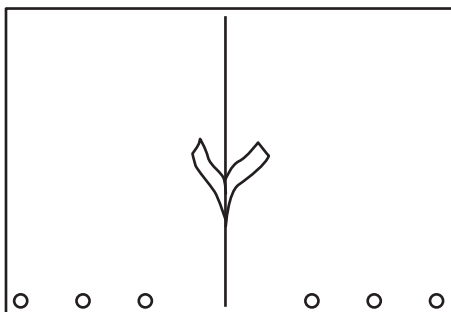
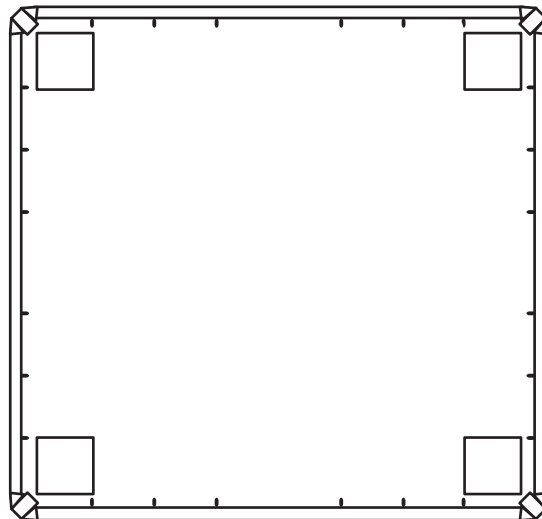
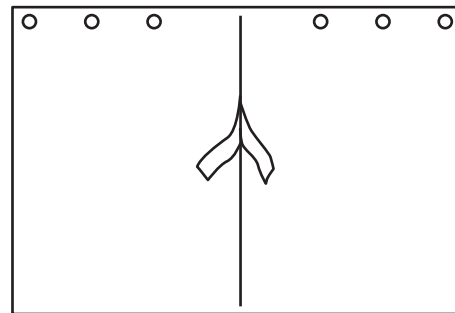
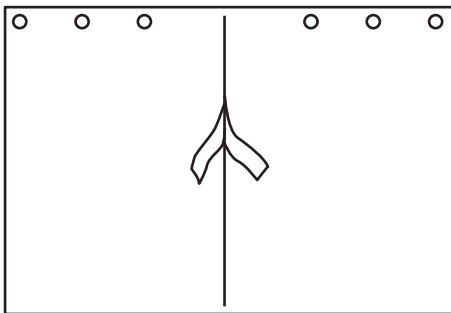
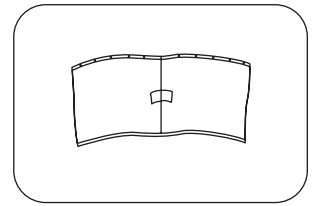

 **GG-L1-Q3** 3 m x 3 m

11

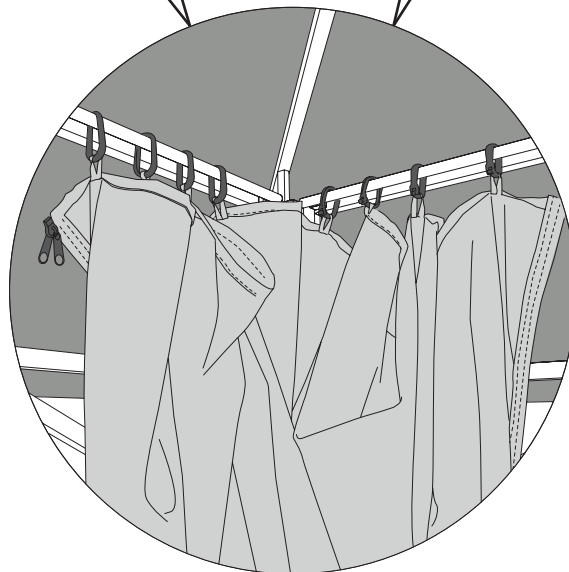
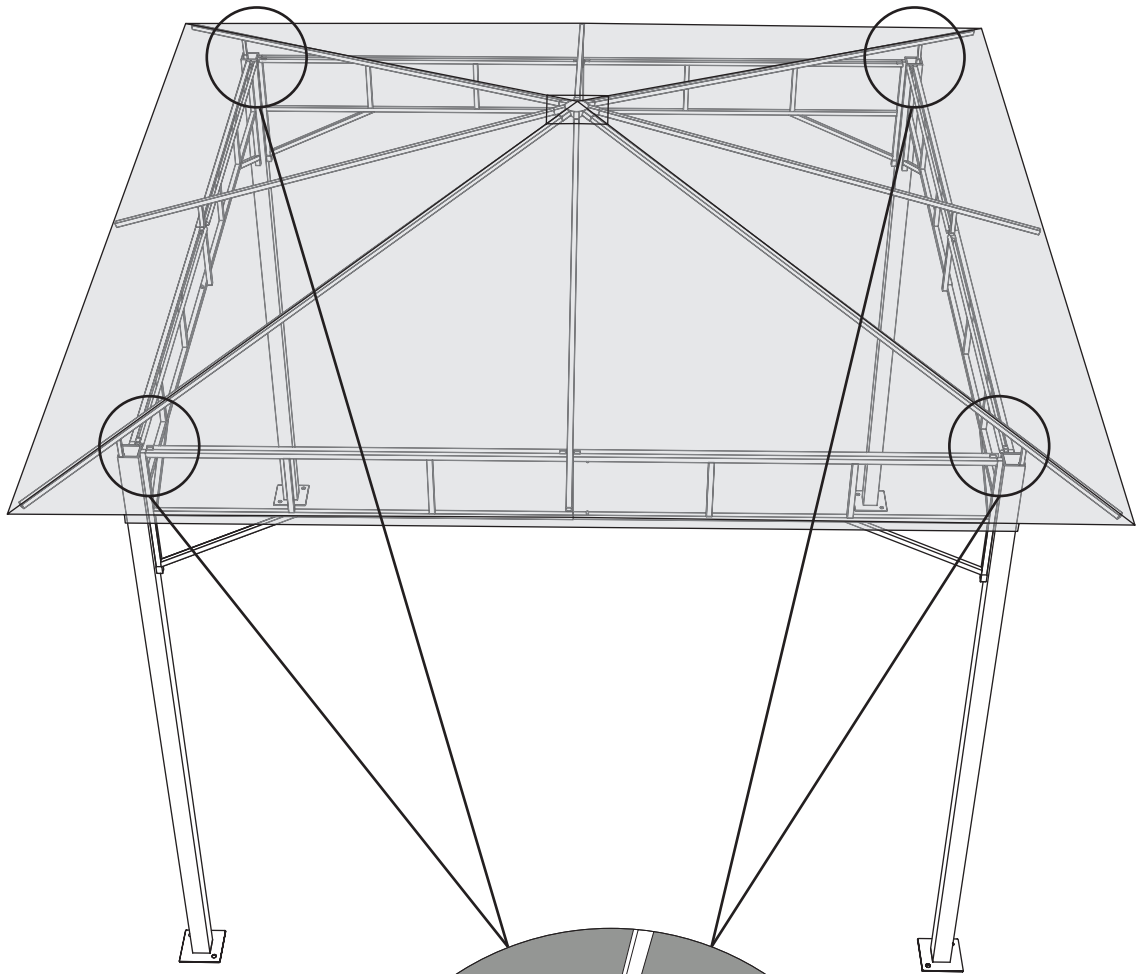
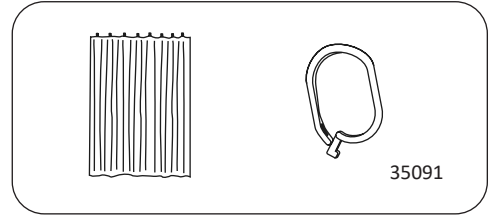

 **GG-L1-Q3 3 m x 3 m**



 **GG-L1-Q3 3 m x 3 m**

