

 **GG-L2-Q2 3 m x 3 m**



07/2024-05

TOOLPORT

 **GG-L2-Q2 3 m x 3 m**

A

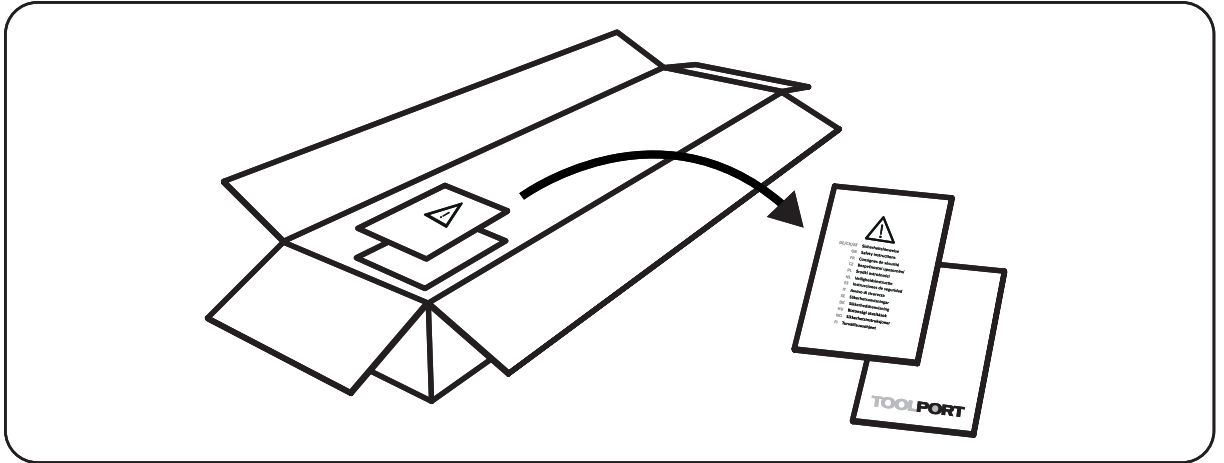



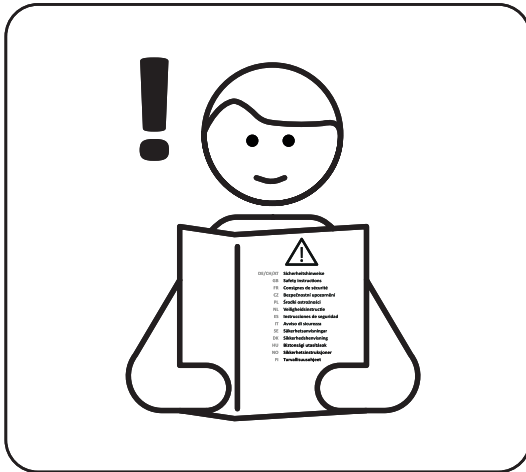



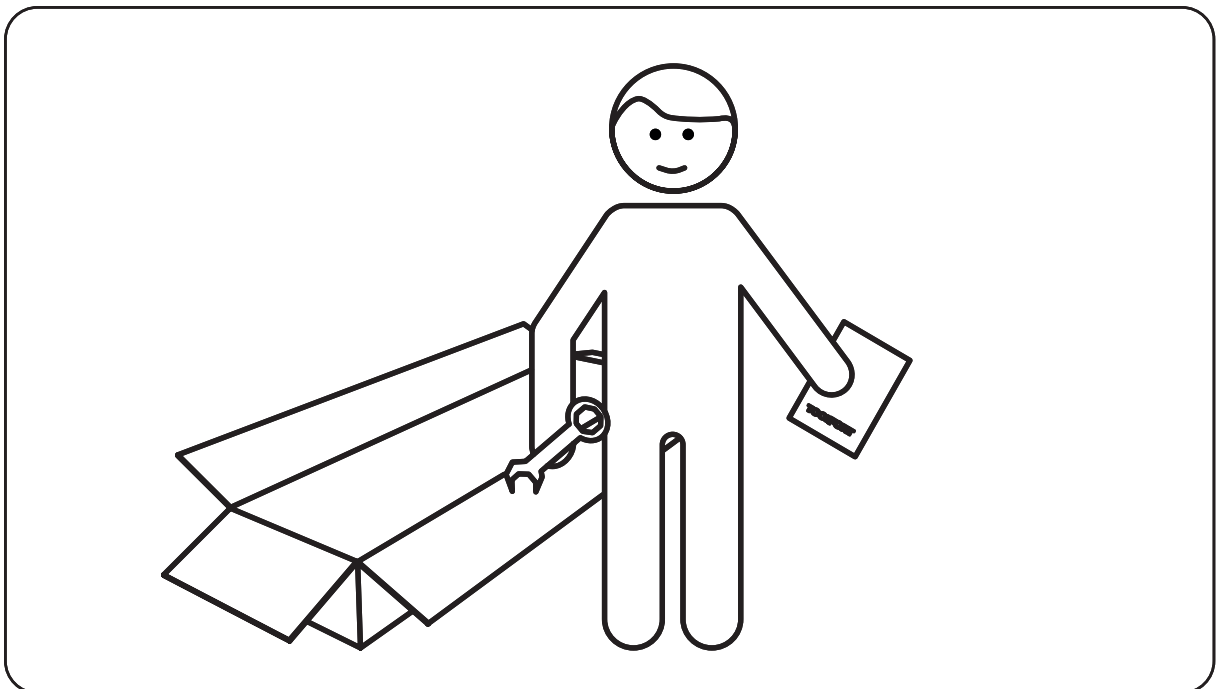



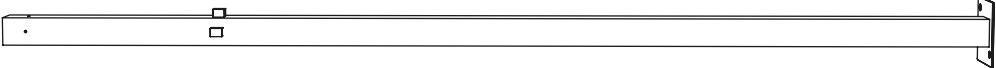



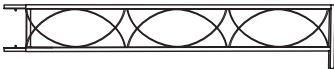
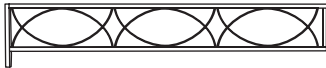

B



C





 **GG-L2-Q2 3 m x 3 m**

Item no.		Q'ty
35206		4
35207		4
35675		4
35208		4
35210		1
35211		4
35212		4
35671		8
		1
		4
35091		32
35090	M6 30 mm 	8
35285	M6 50 mm 	16
35137		8
35086		40
35088		16
35283		16
35154		16
35144		2

 **GG-L2-Q2 3 m x 3 m**

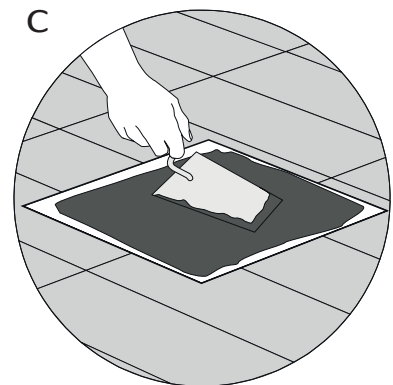
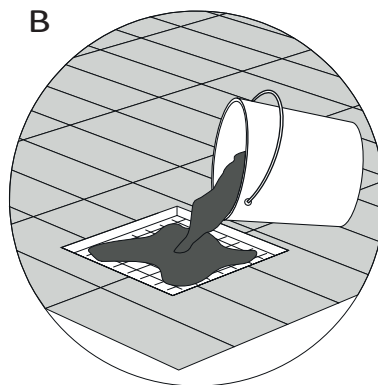
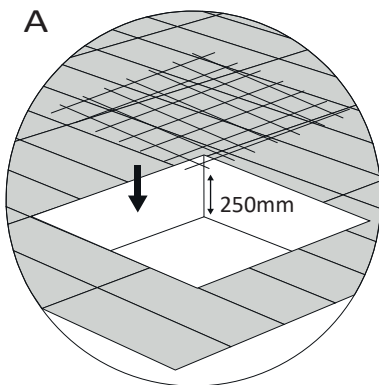
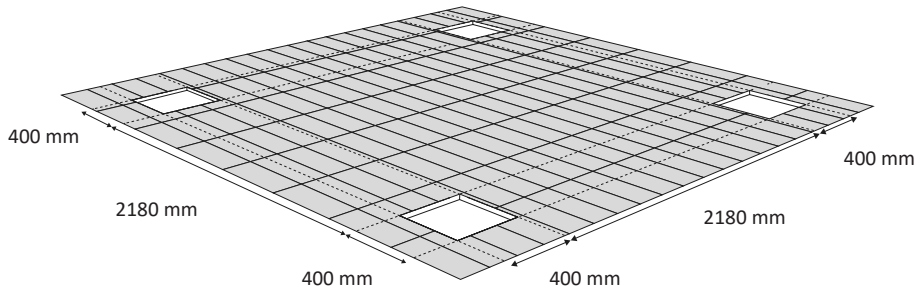
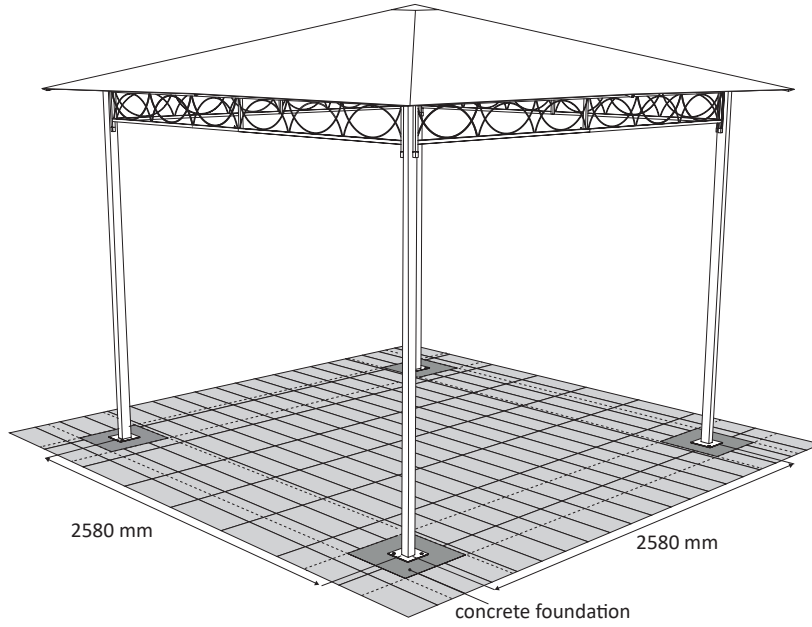
1



 **GG-L2-Q2 3 m x 3 m**

2

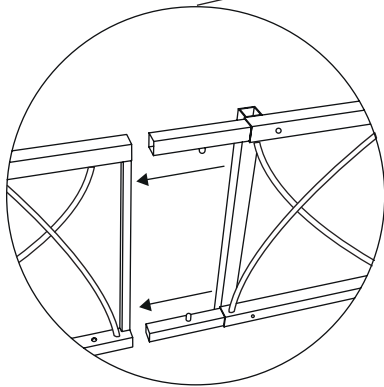
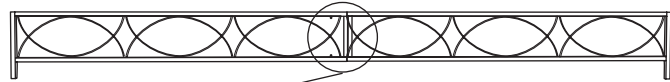
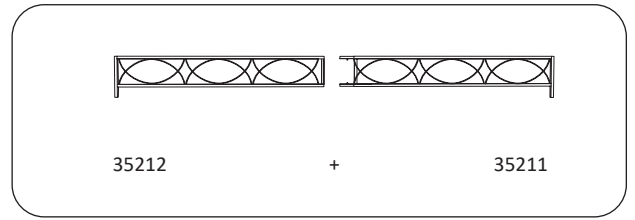

3

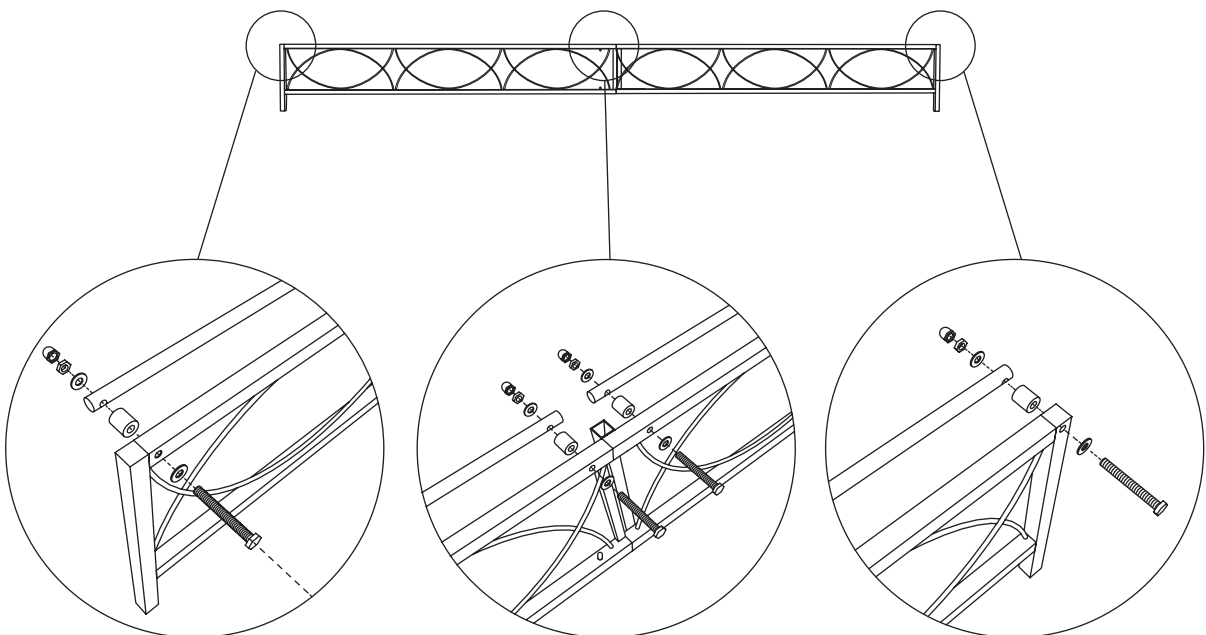
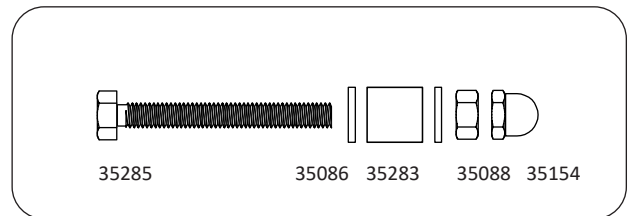

 **GG-L2-Q2 3 m x 3 m**

4

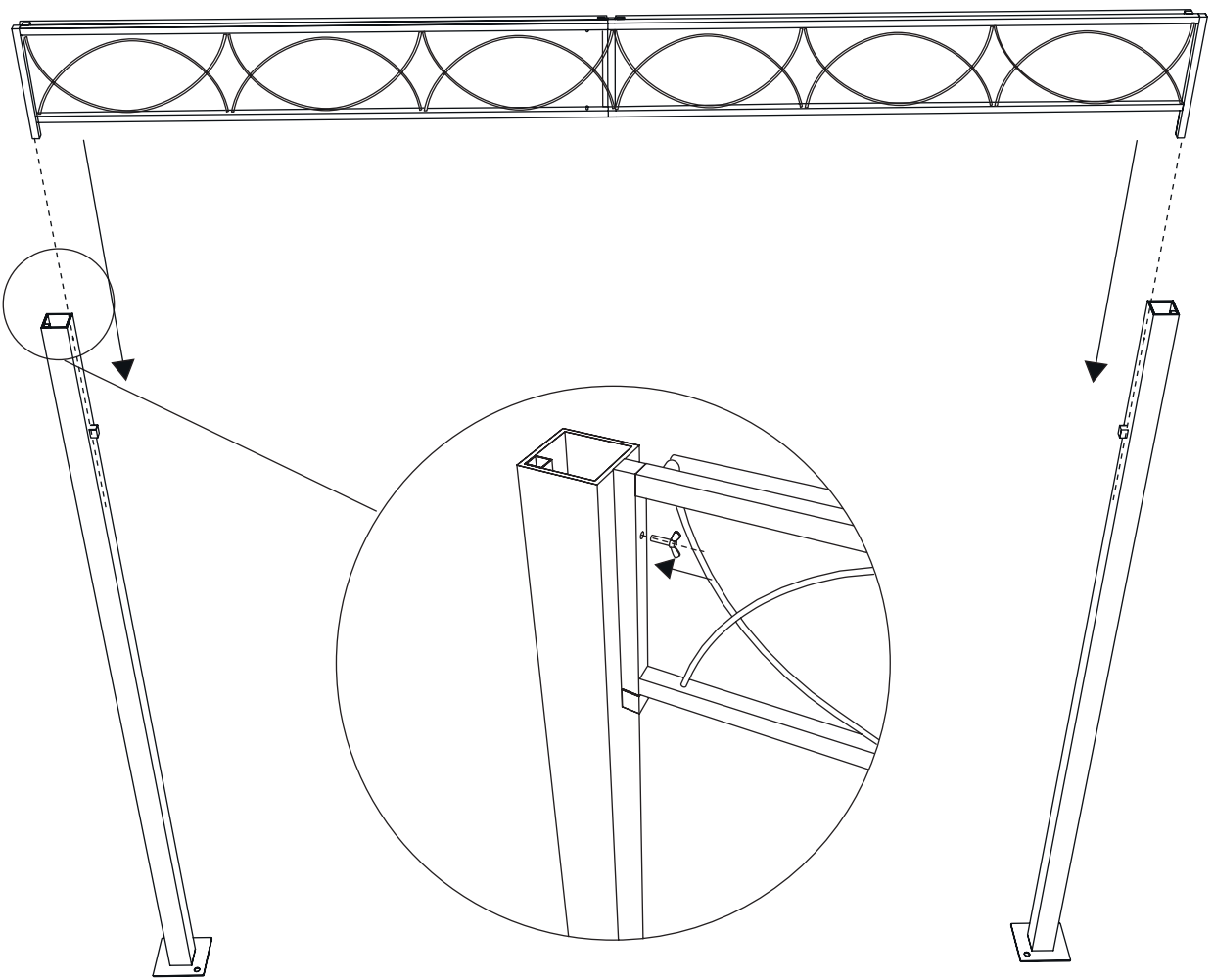
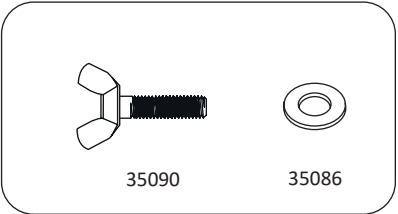
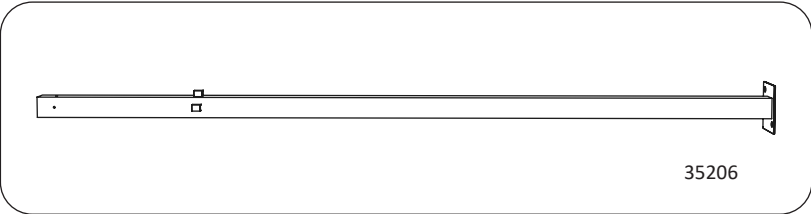

 **GG-L2-Q2 3 m x 3 m**

5

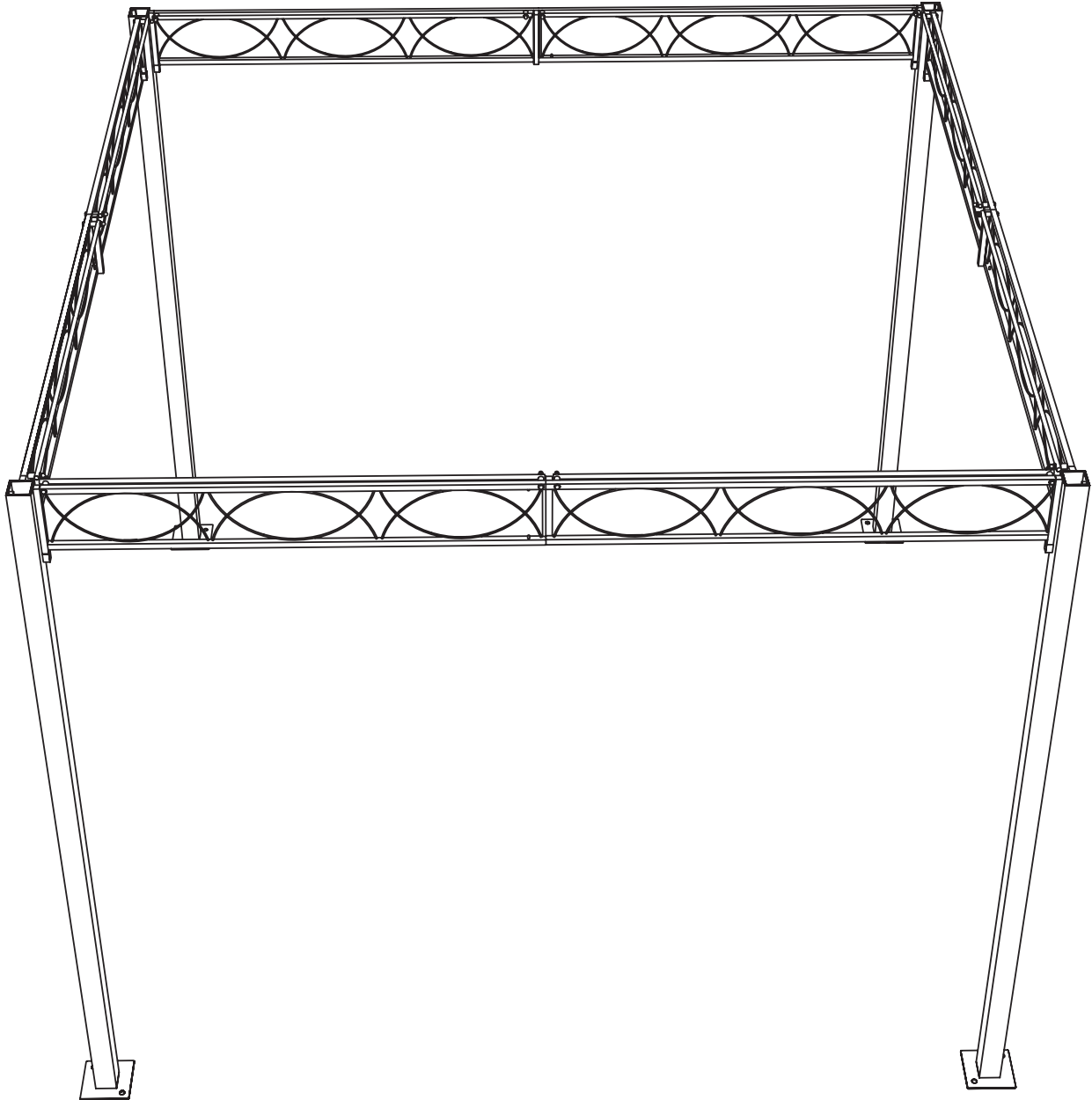

 **GG-L2-Q2 3 m x 3 m**

6

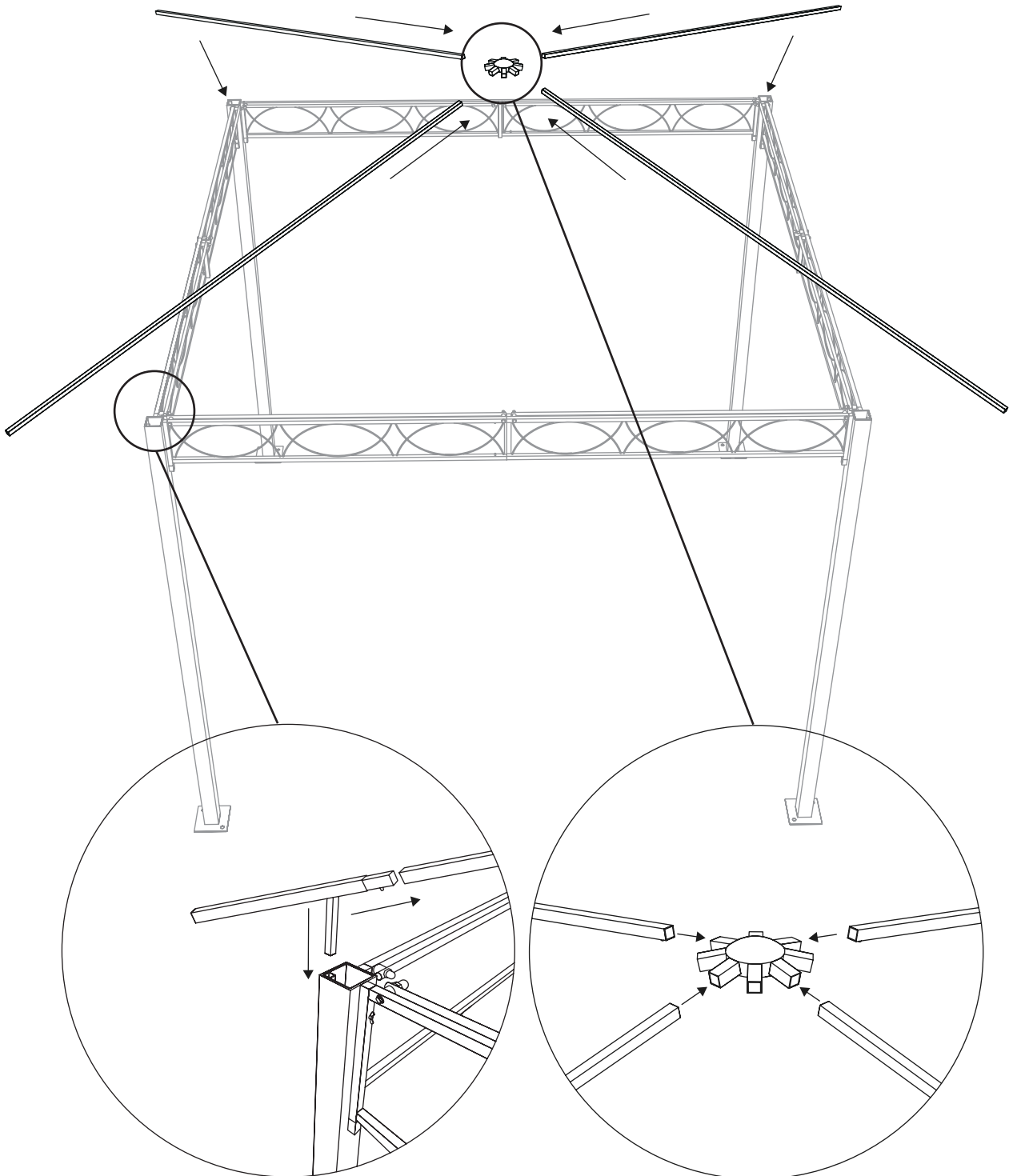
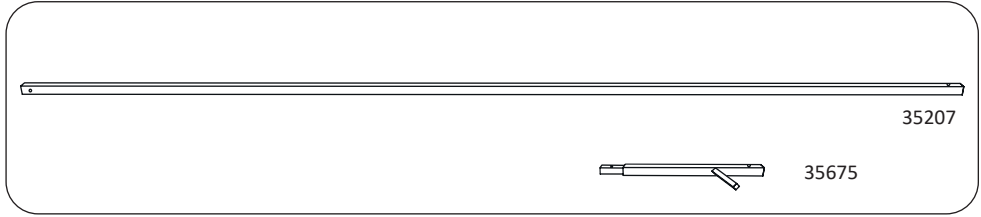
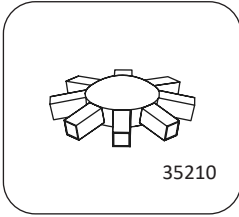

 **GG-L2-Q2 3 m x 3 m**

7

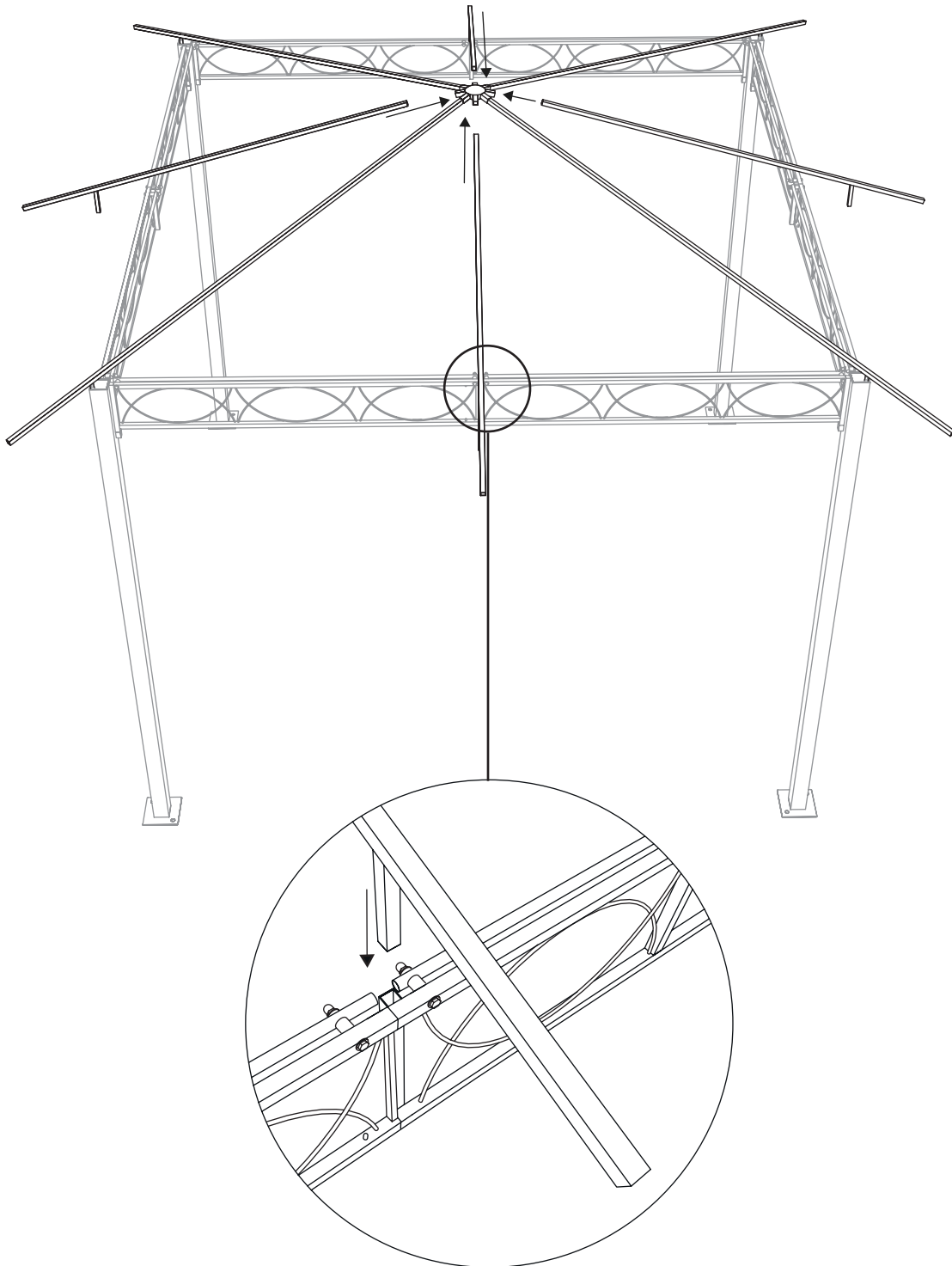
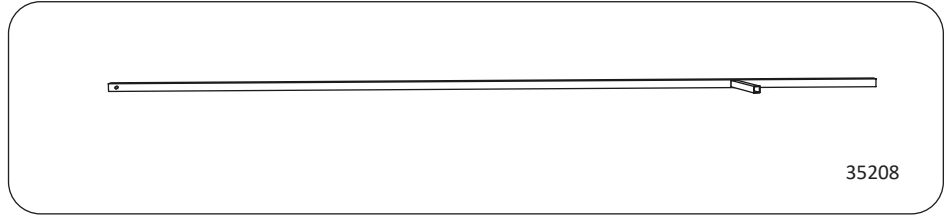

 **GG-L2-Q2 3 m x 3 m**

8

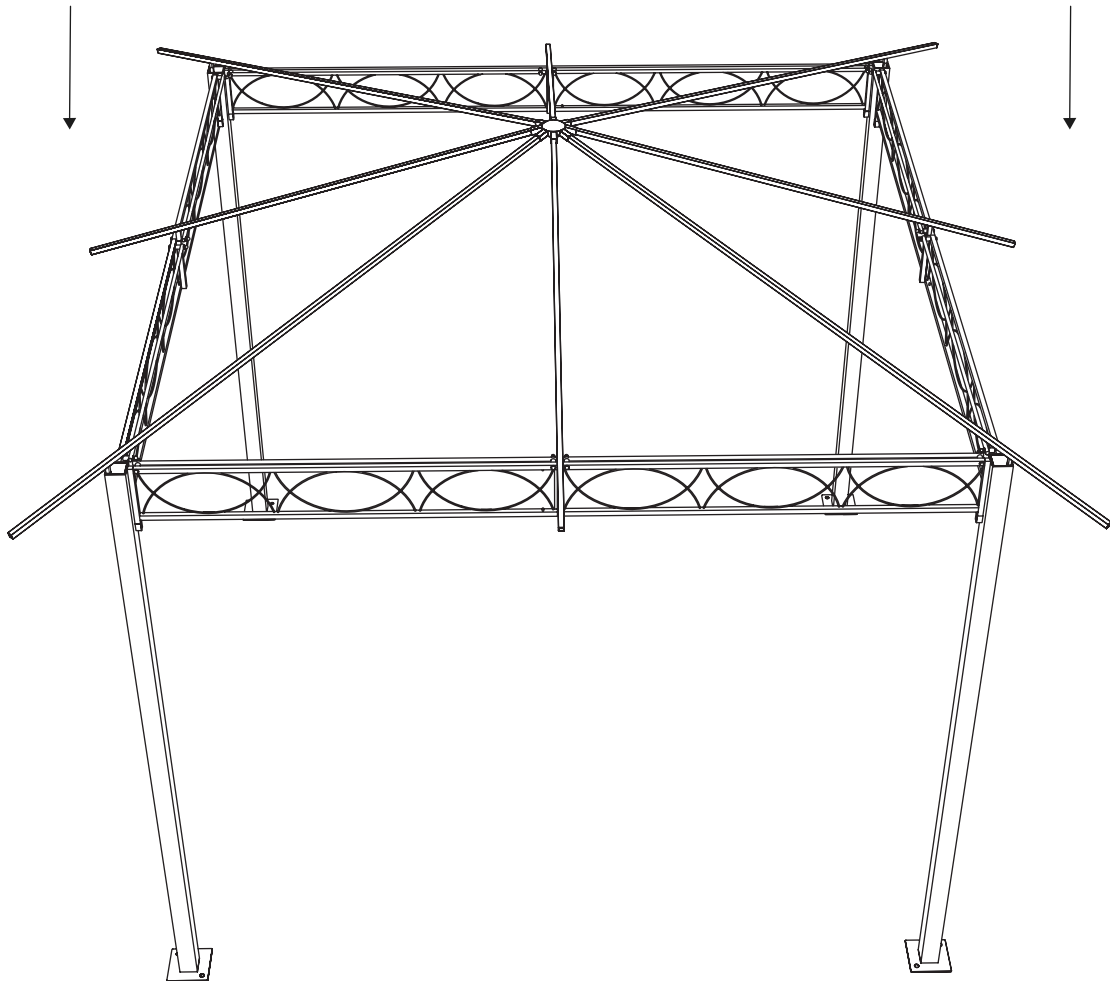
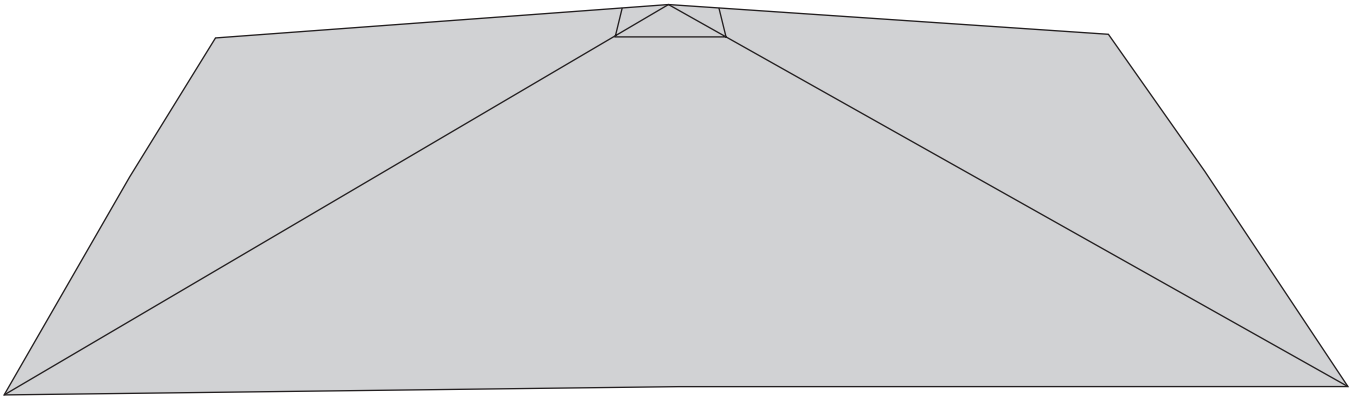
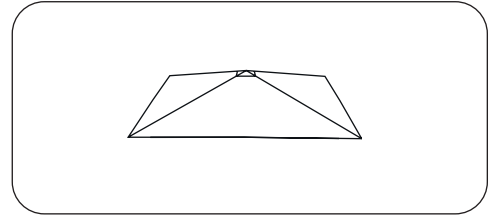

 **GG-L2-Q2 3 m x 3 m**

9

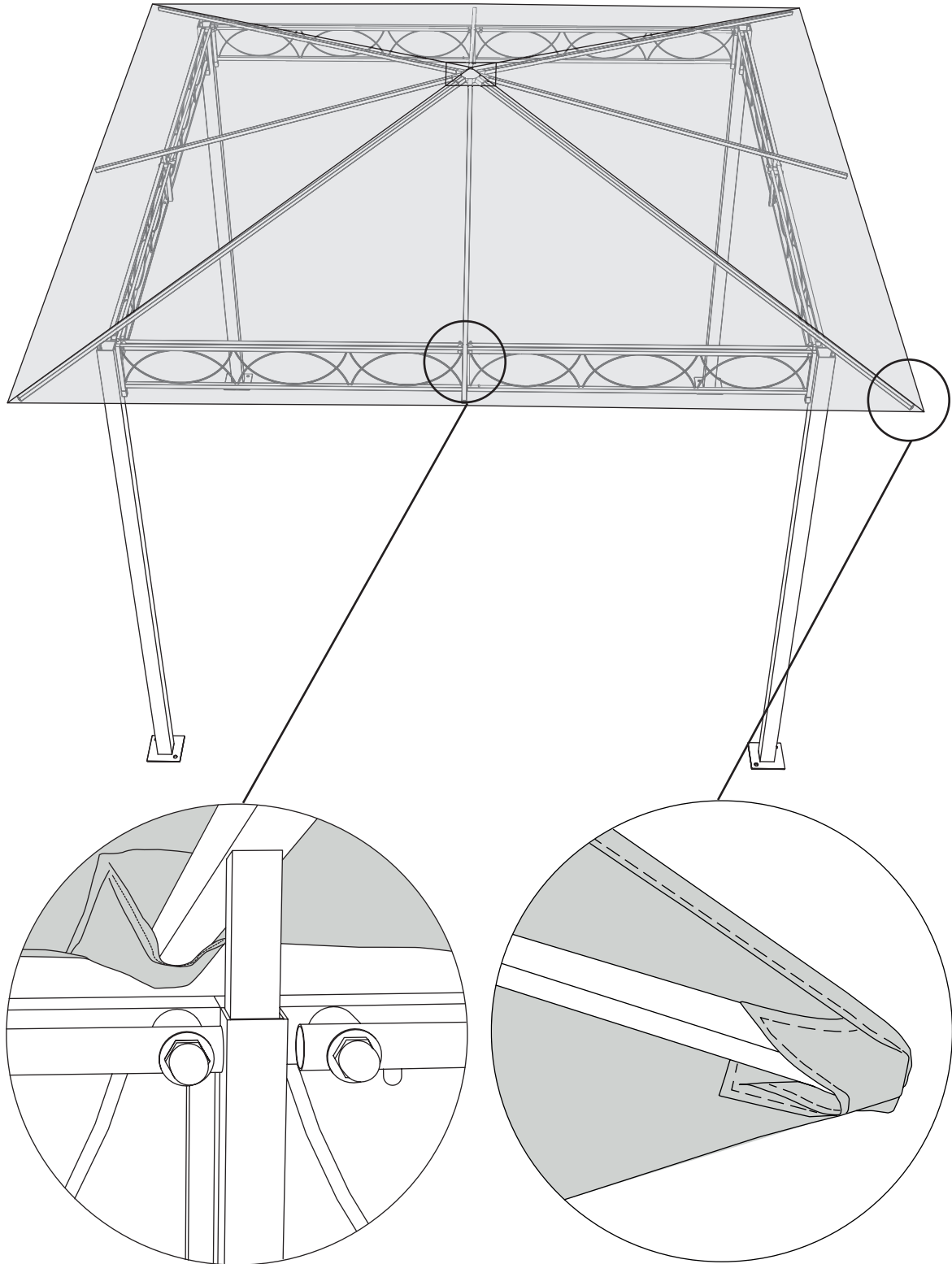

 **GG-L2-Q2 3 m x 3 m**

10

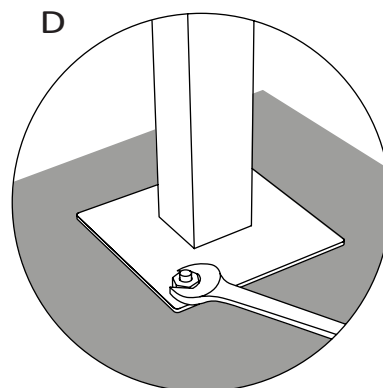
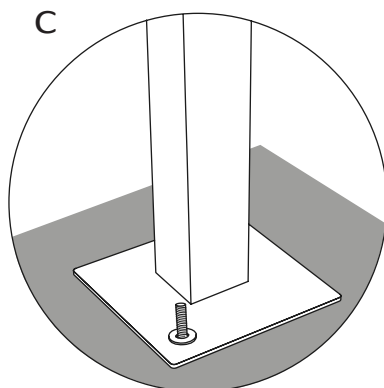
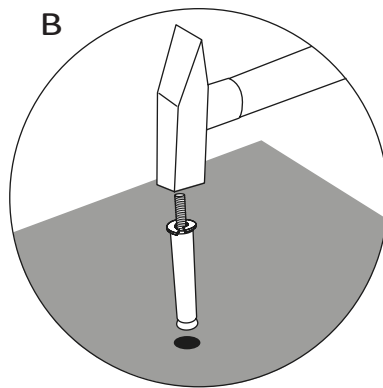
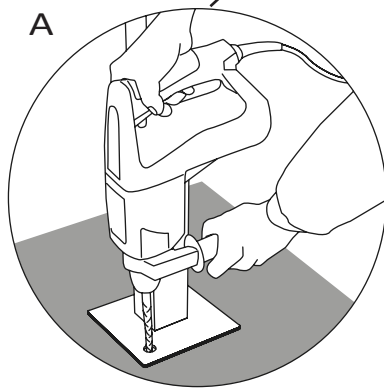
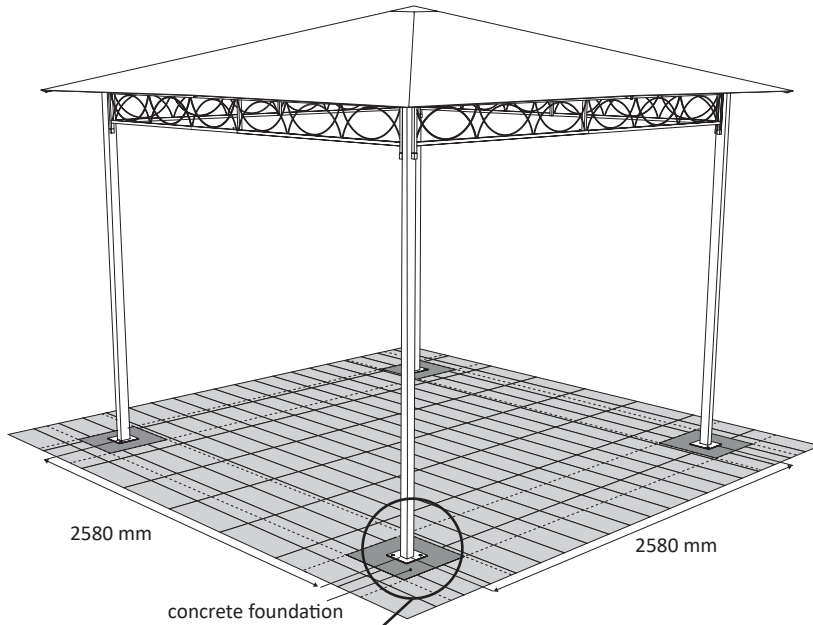
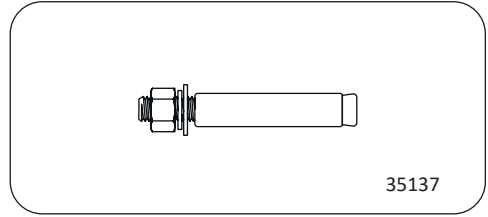

 **GG-L2-Q2** 3 m x 3 m

11

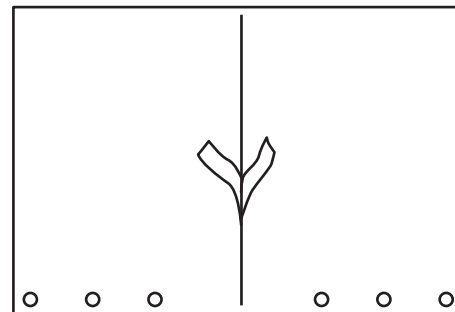
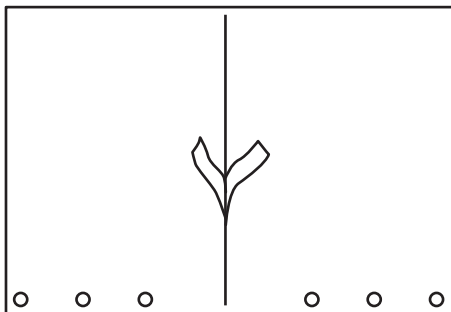
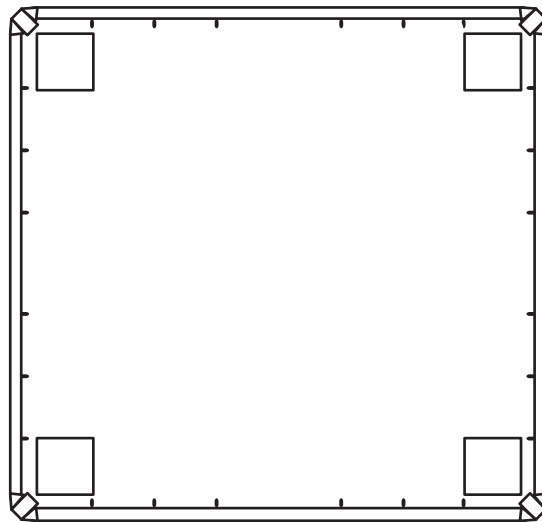
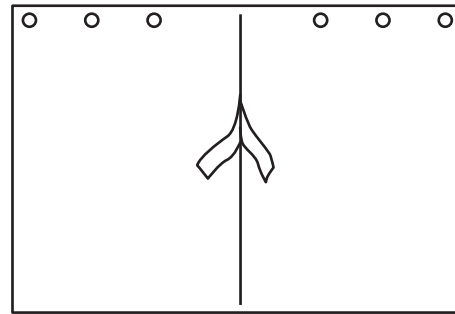
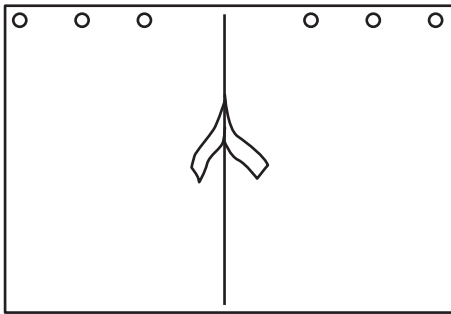
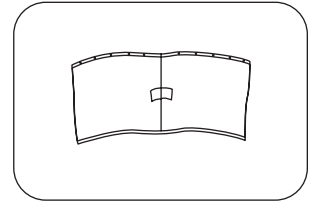

 **GG-L2-Q2 3 m x 3 m**

12

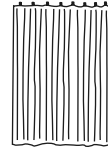

35091

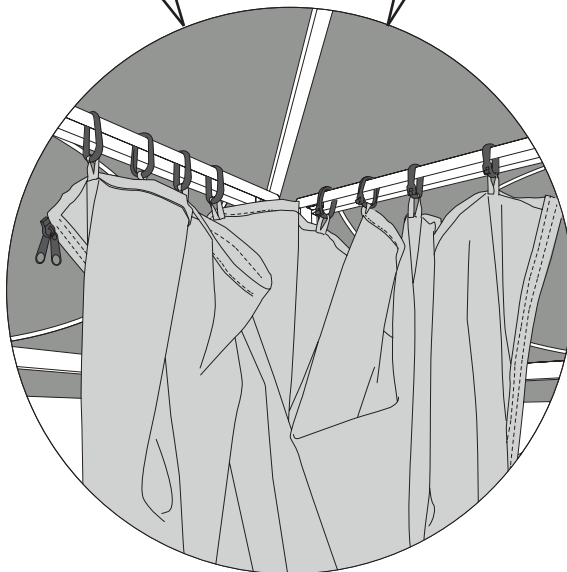
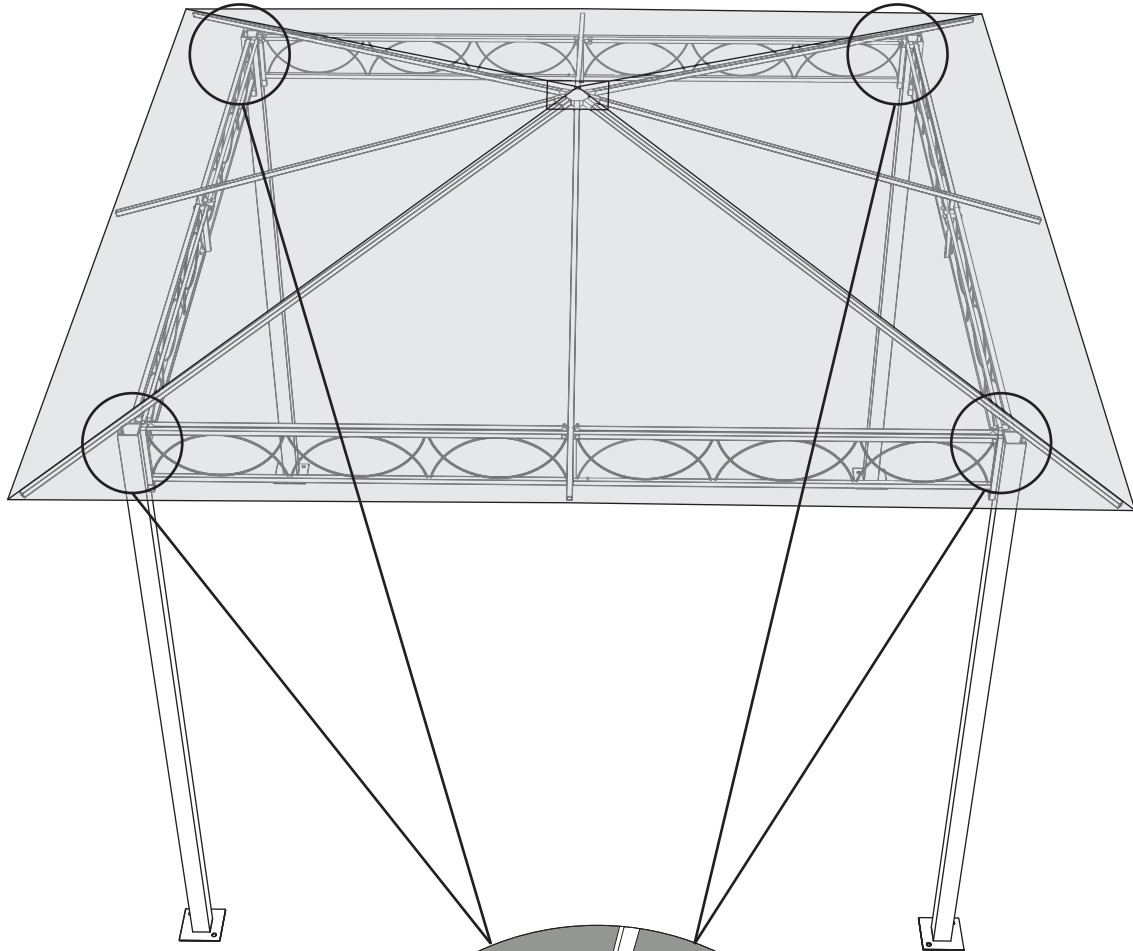

 **GG-L2-Q2 3 m x 3 m**

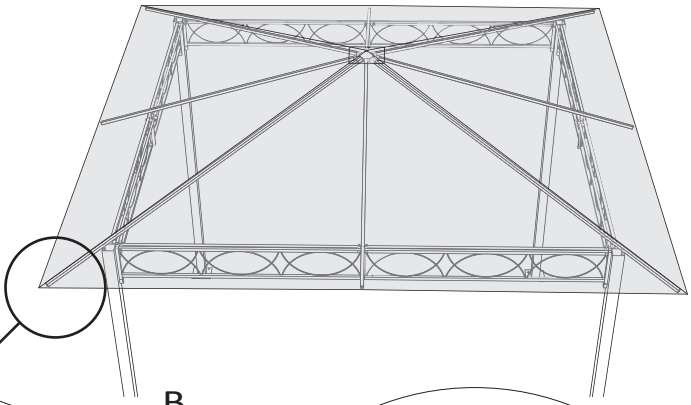

A

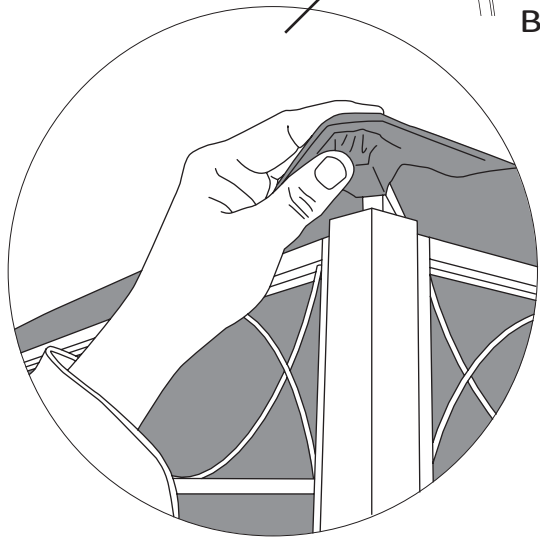

B

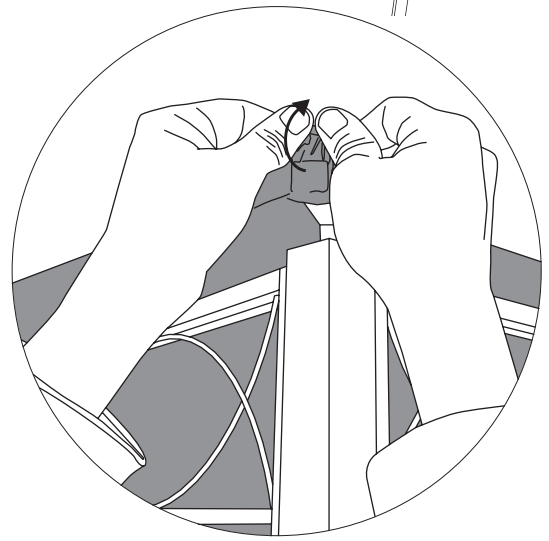

C

