

 **GG-L2-Q2 3 m x 4 m**



07/2024-04

**TOOLPORT**



 **GG-L2-Q2 3 m x 4 m**

**A**

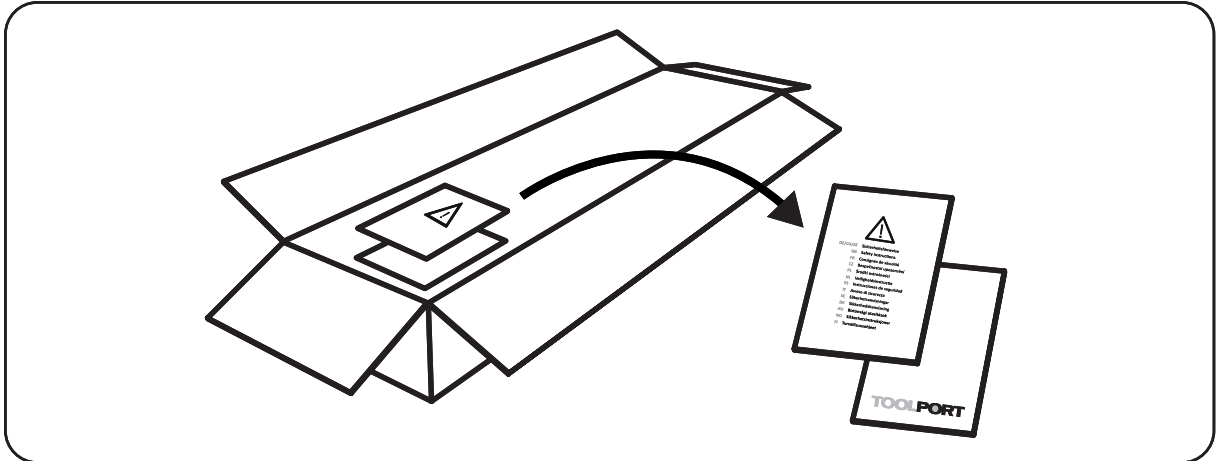



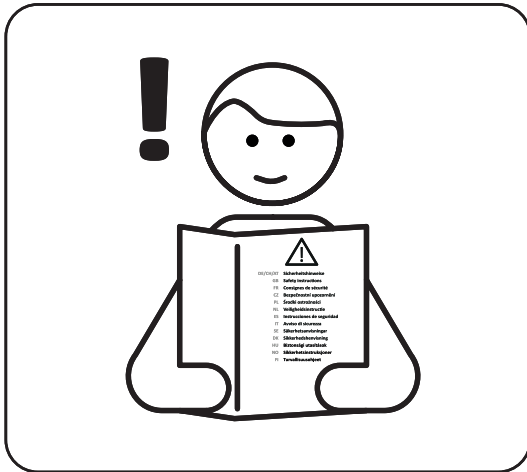



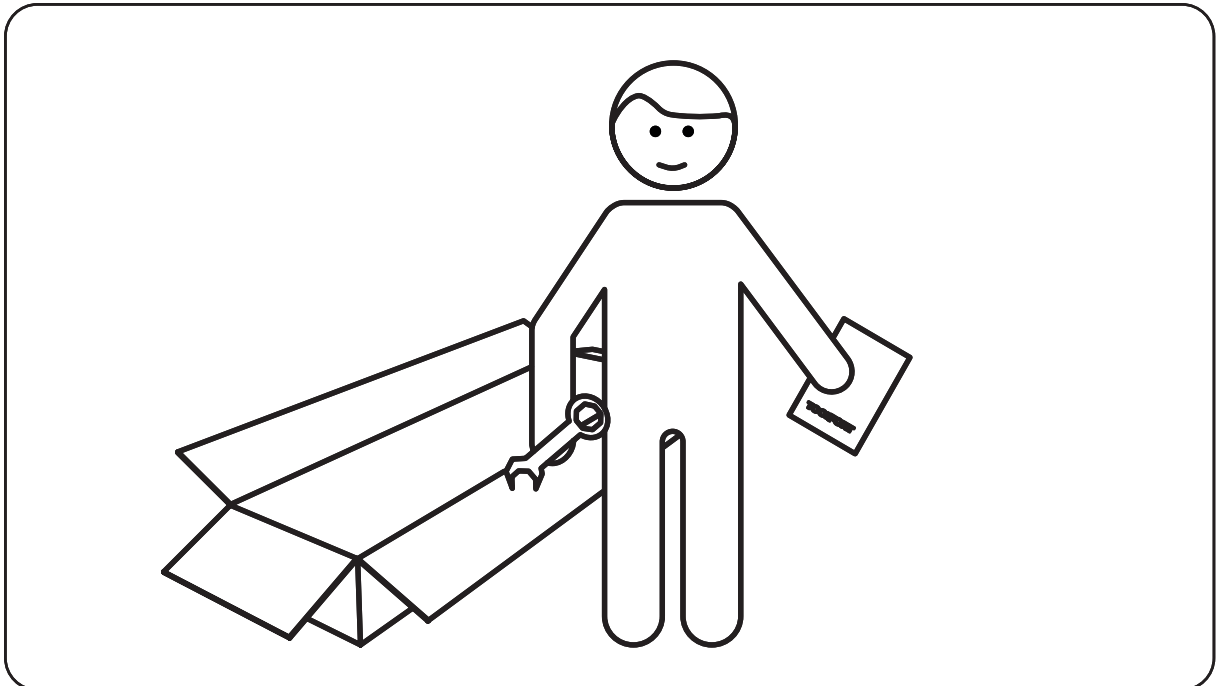

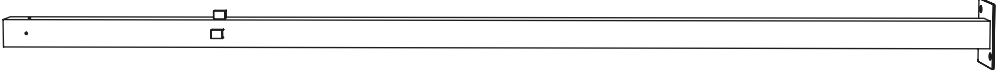

**B**



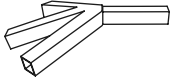
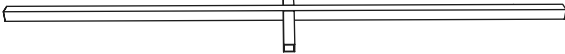
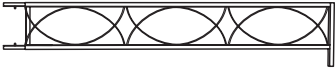
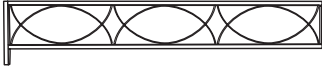
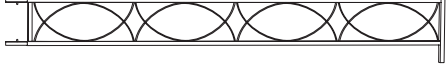

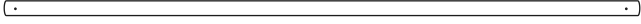
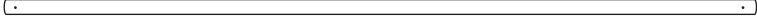





**C**

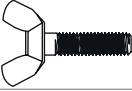

 **GG-L2-Q2 3 m x 4 m**

Item no.		Q'ty
35206		4
35207		4
35675		4
35208		4
35217		2
35216		1
35211		2
35212		2
35218		2
35219		2
35671		4
35672		4
		1
		4
35091		36

 **GG-L2-Q2 3 m x 4 m**

Item no.		Q'ty
35090	M6 30 mm 	8
35137		8
35285	M6 50 mm 	16
35086		40
35088		16
35283		16
35154		16
35144		2

 **GG-L2-Q2 3 m x 4 m**

1

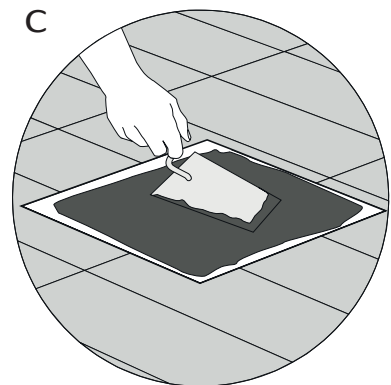
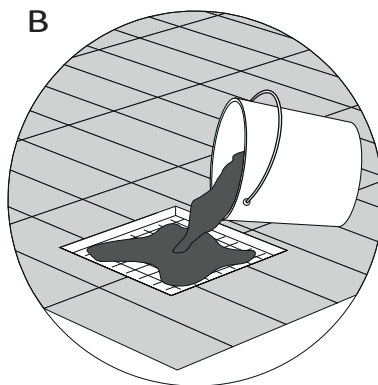
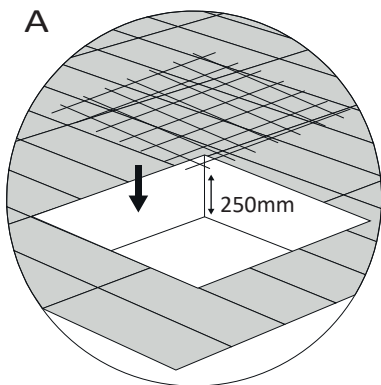
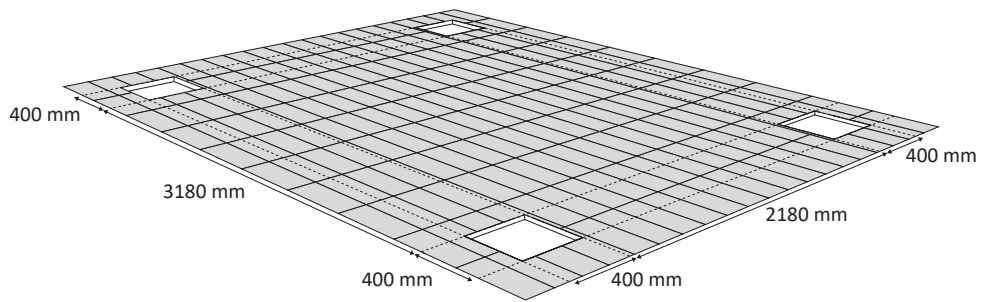
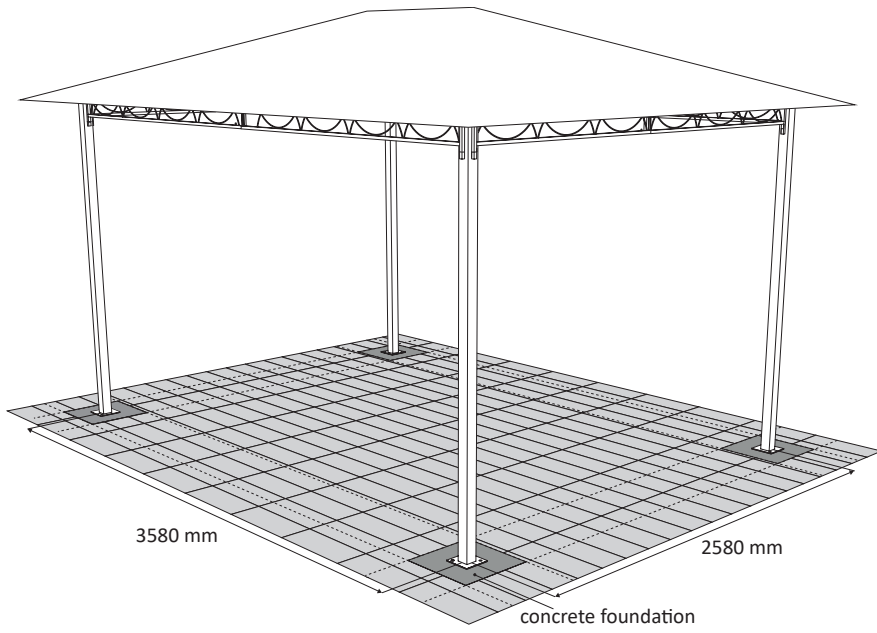

 **GG-L2-Q2 3 m x 4 m**

2

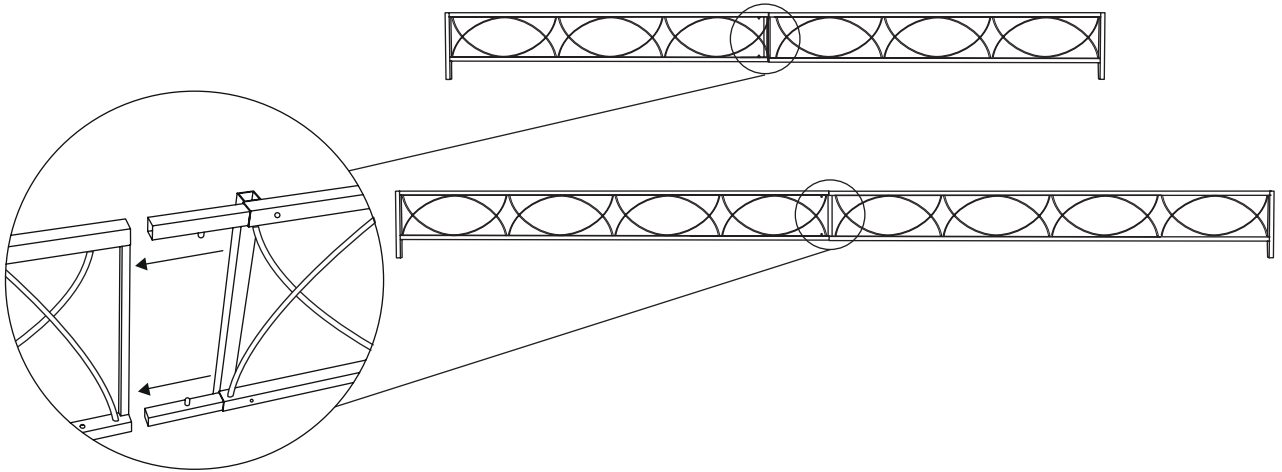
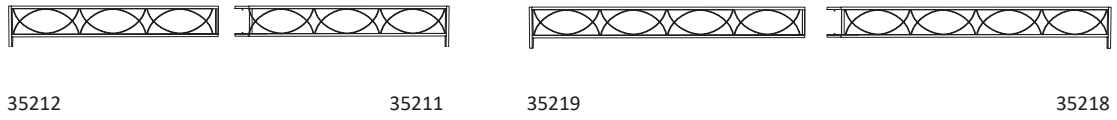

3

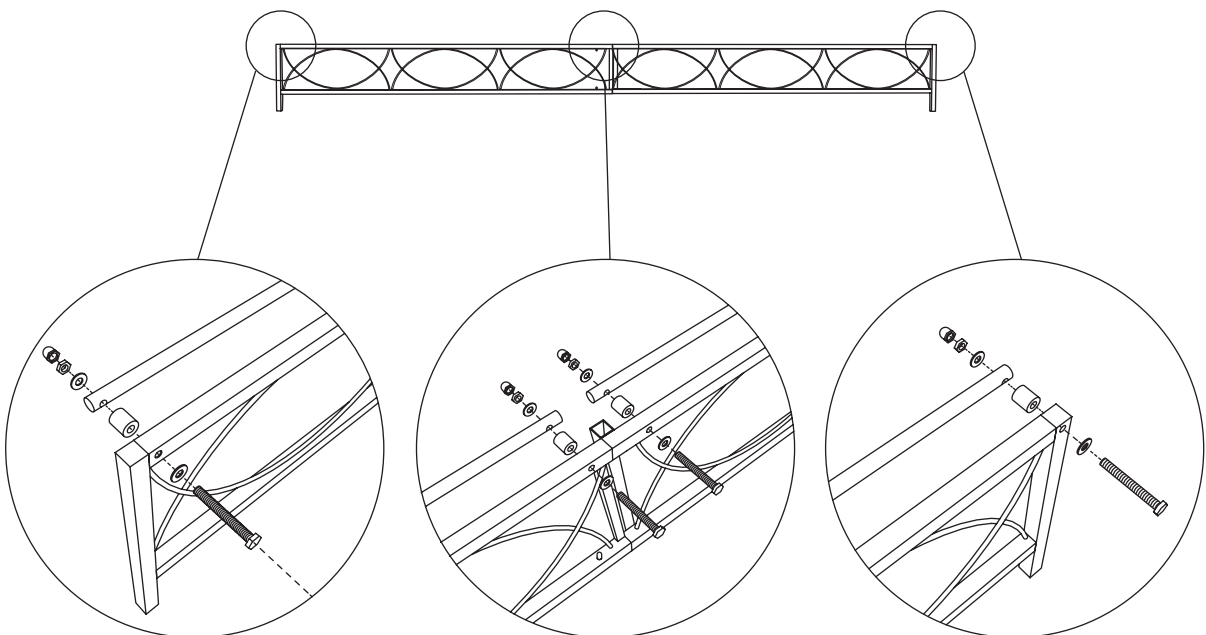
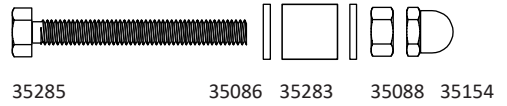
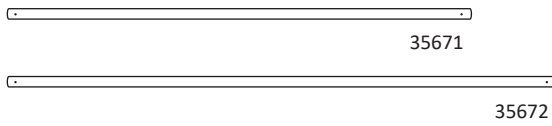

 **GG-L2-Q2 3 m x 4 m**

4

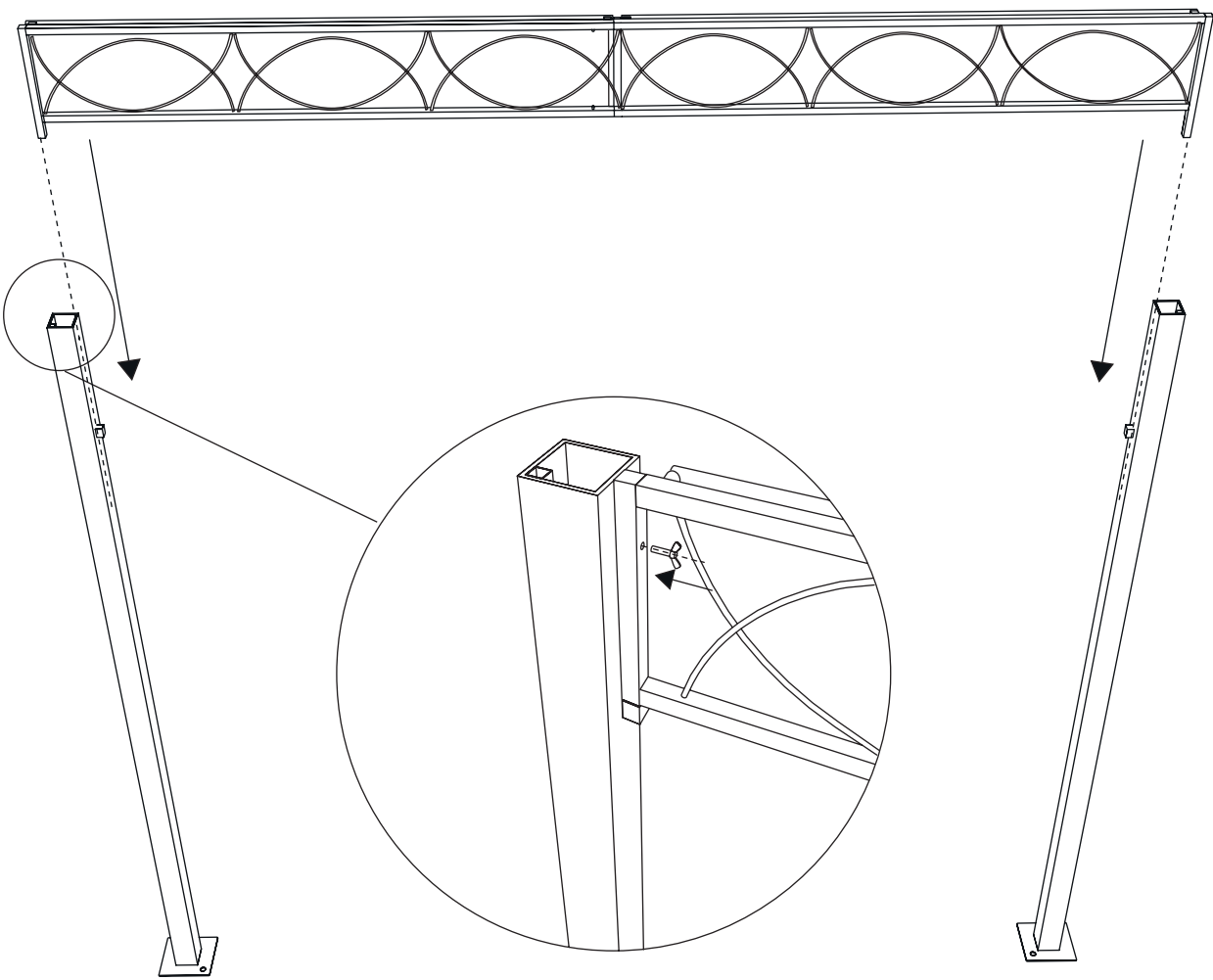
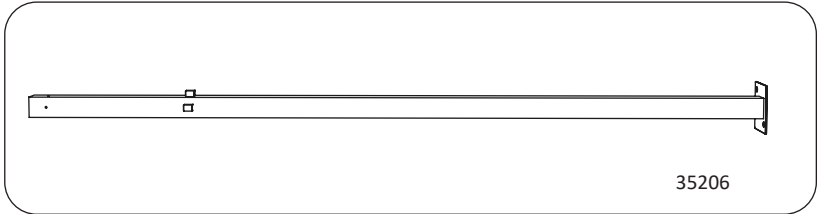
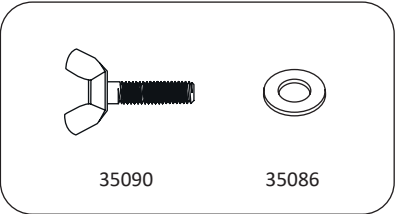



 **GG-L2-Q2 3 m x 4 m**

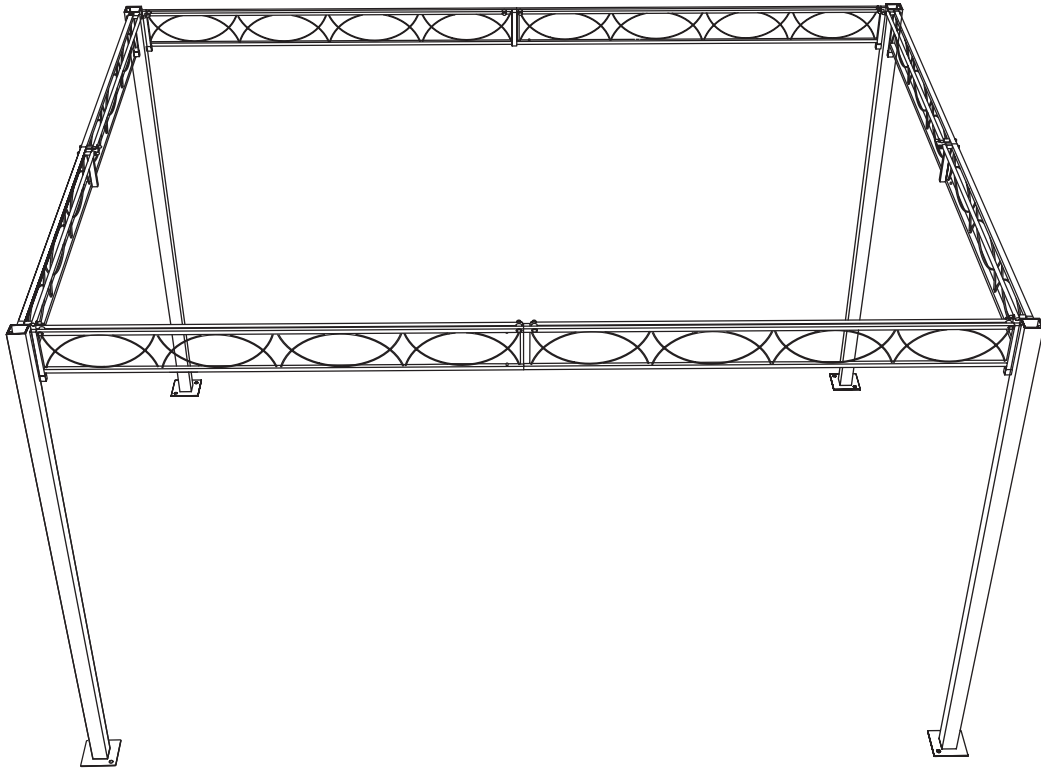

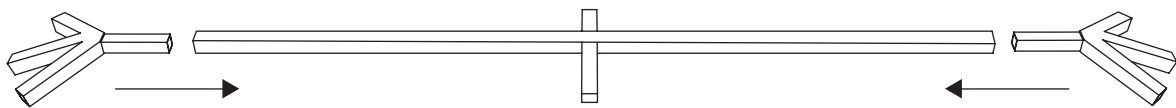
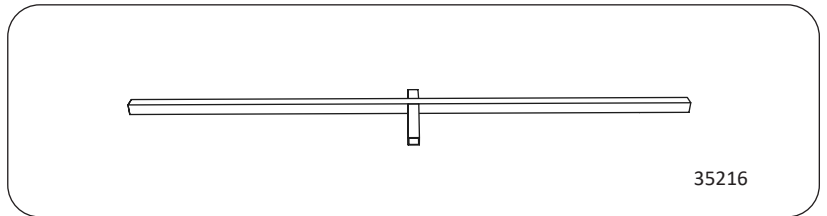
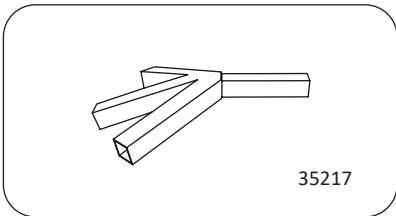

5

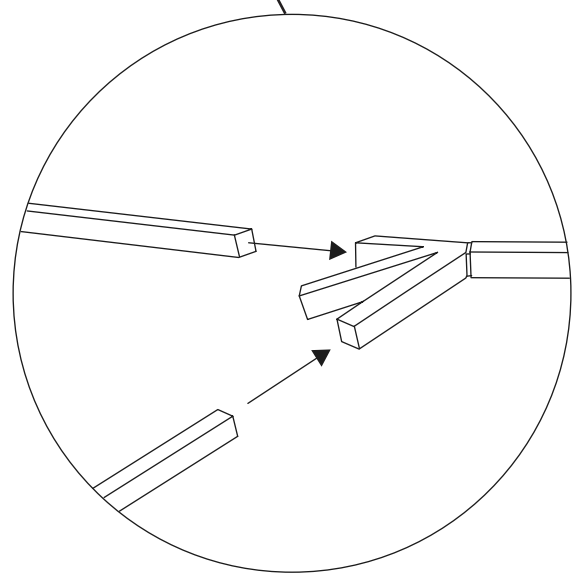
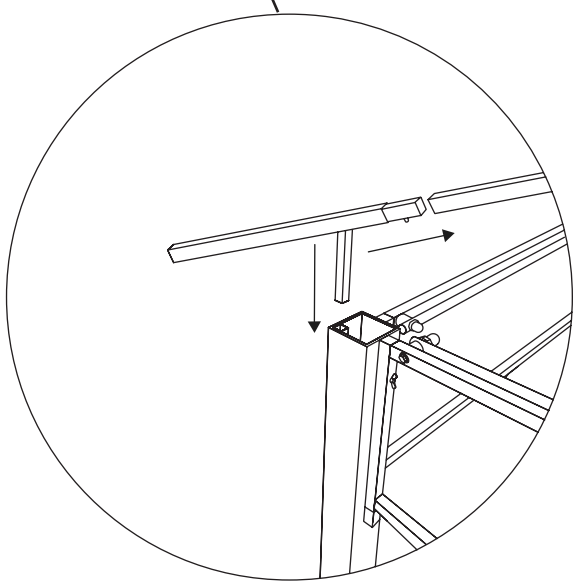
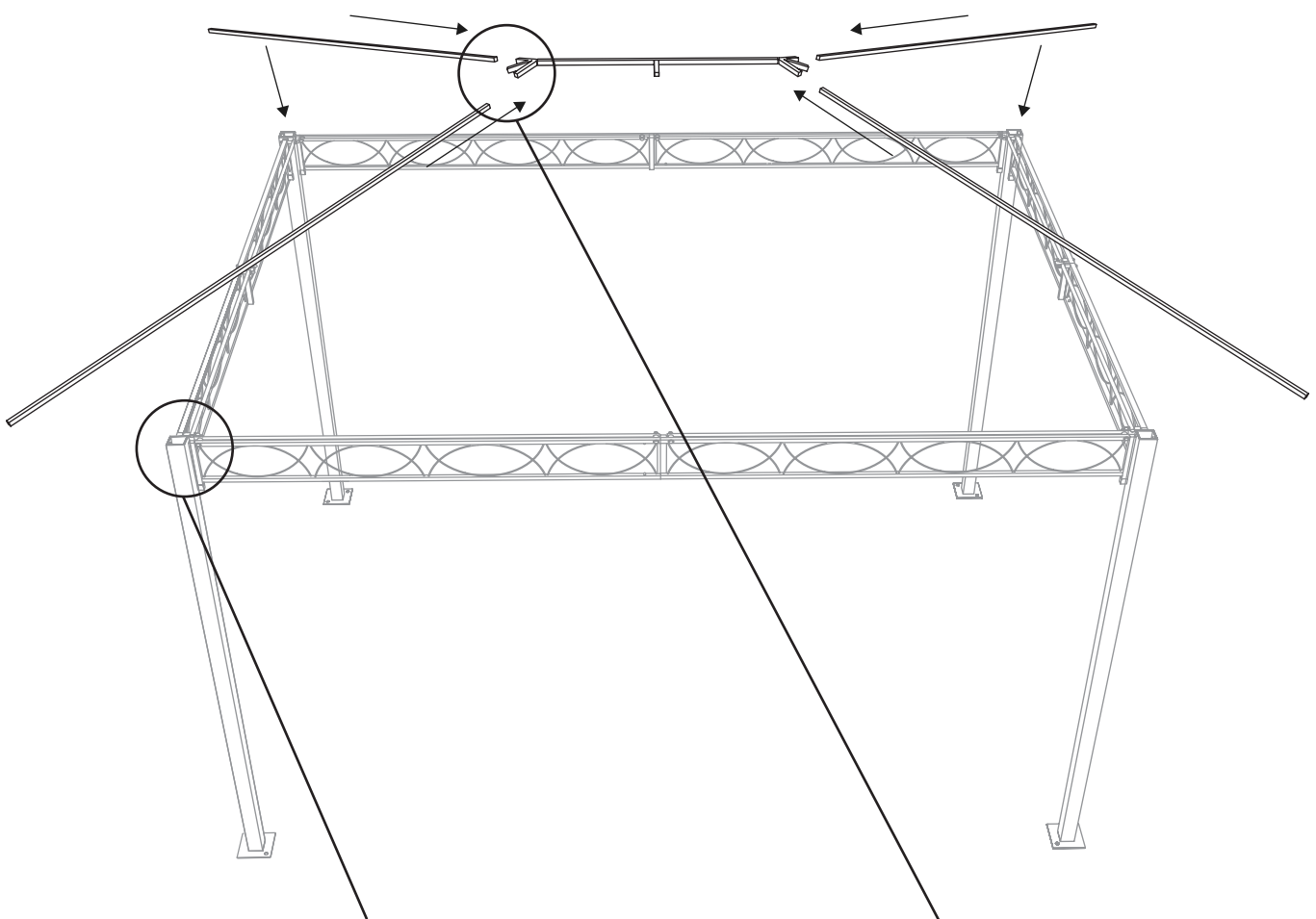
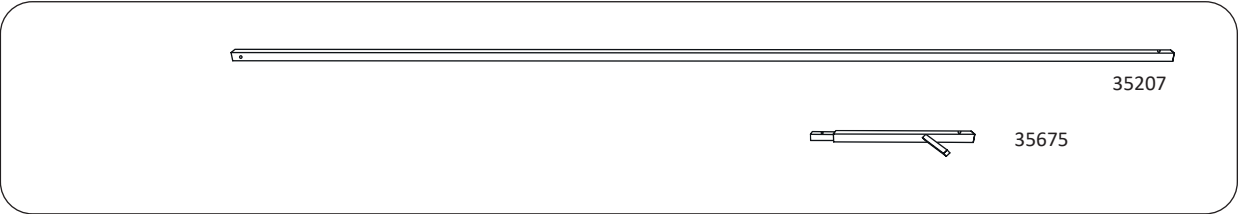

 **GG-L2-Q2 3 m x 4 m**

6



 **GG-L2-Q2 3 m x 4 m**

7

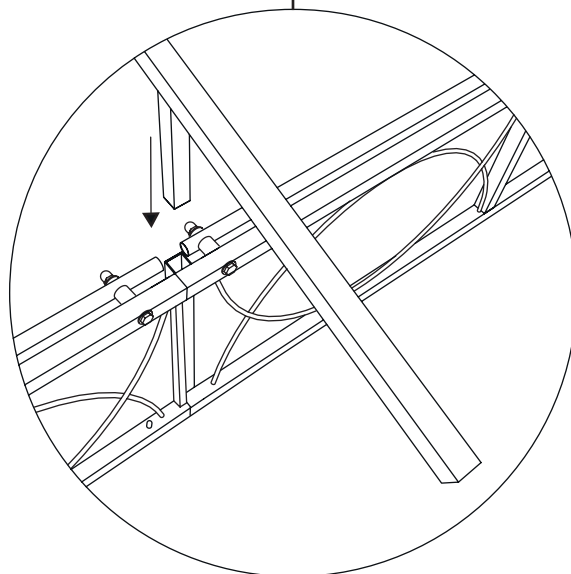
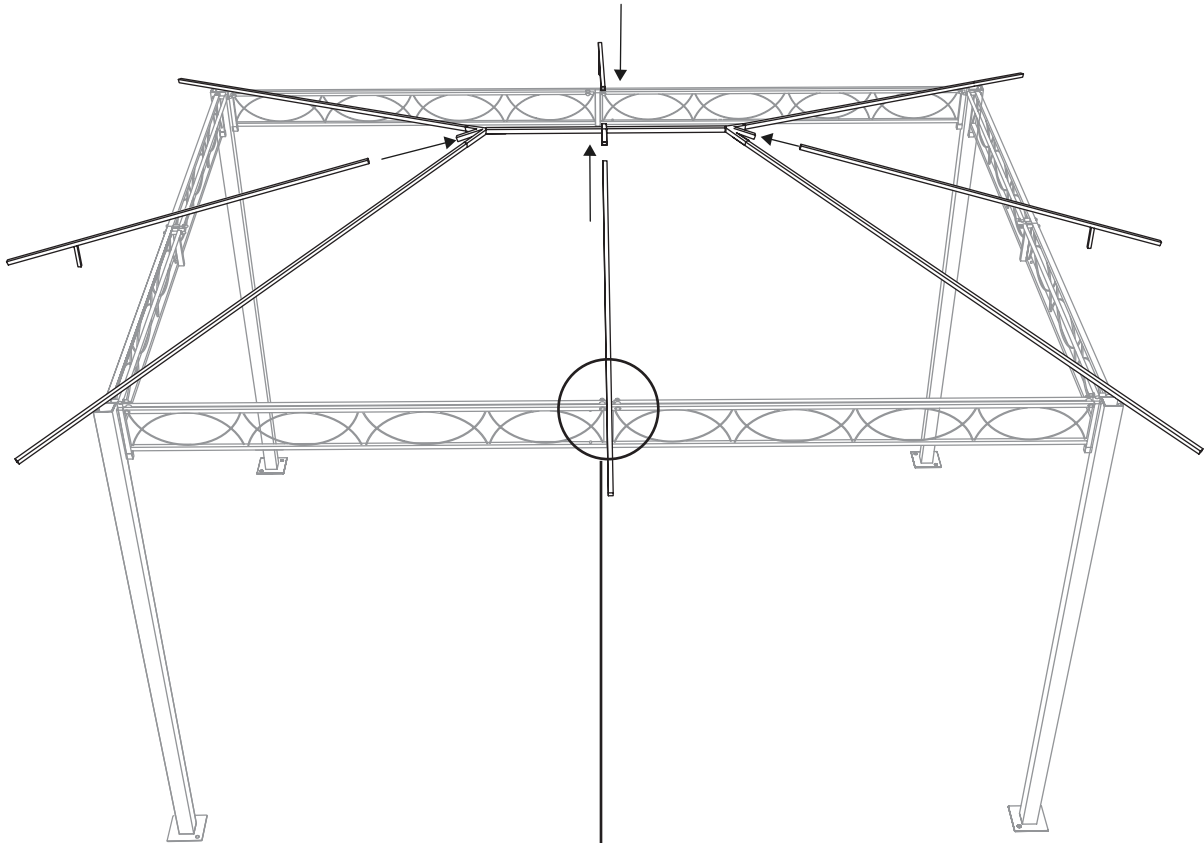
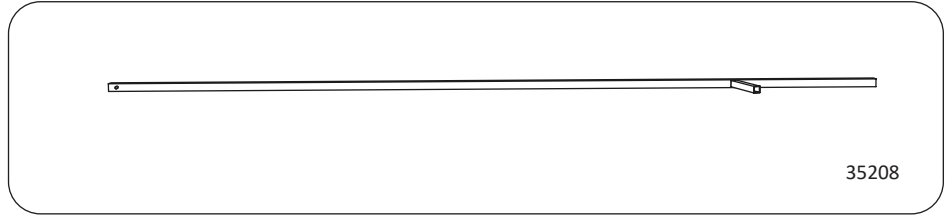

 **GG-L2-Q2 3 m x 4 m**

8

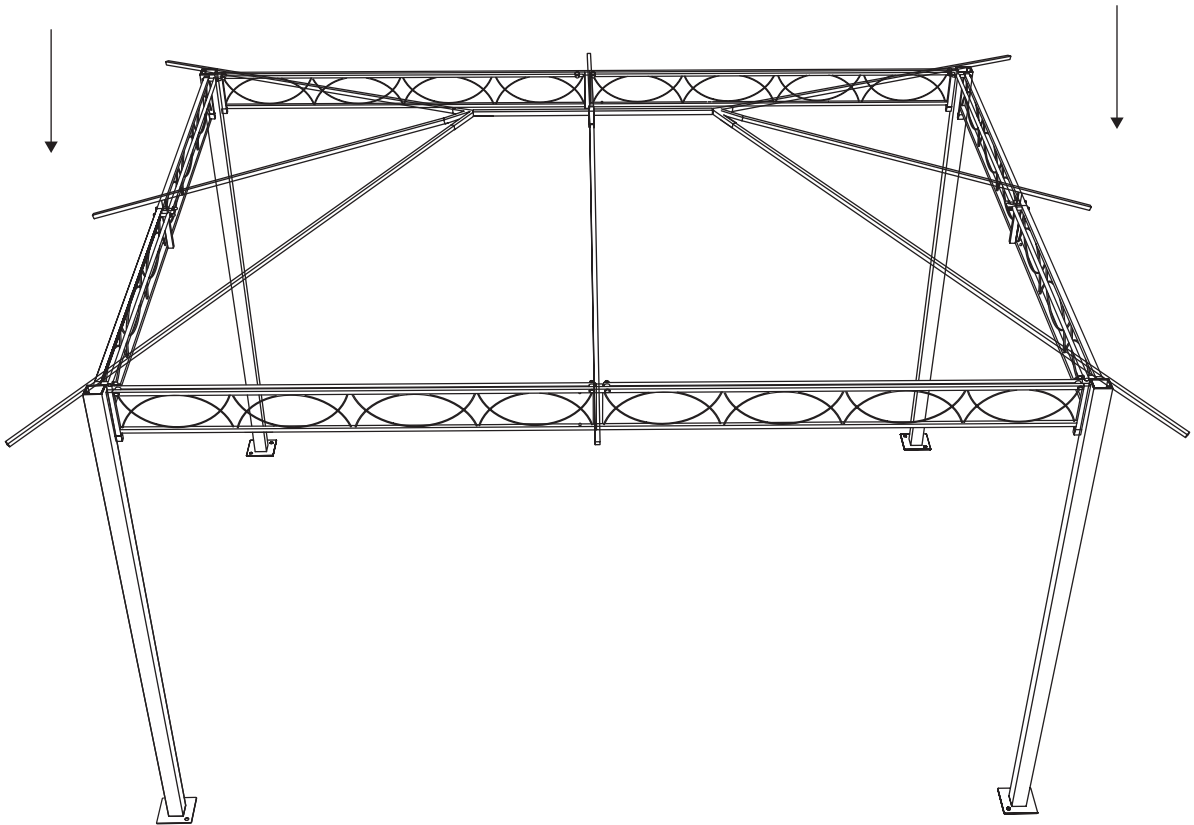
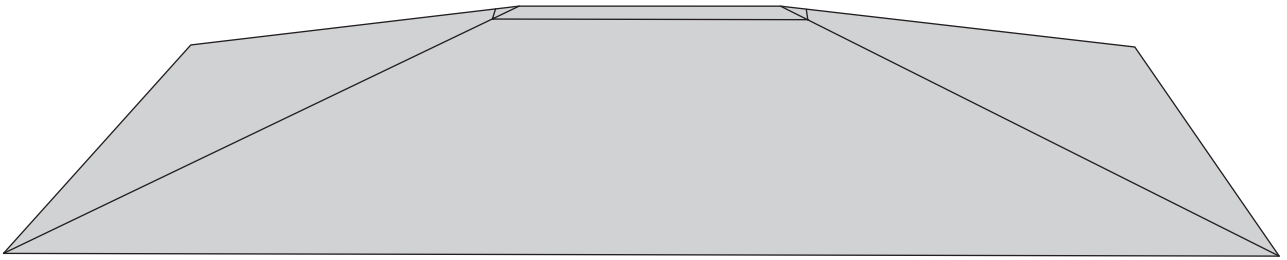
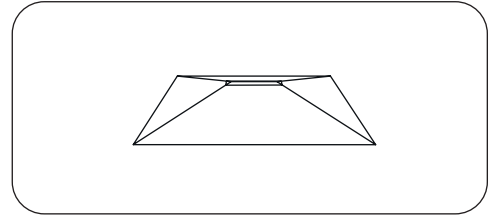

 **GG-L2-Q2 3 m x 4 m**

9

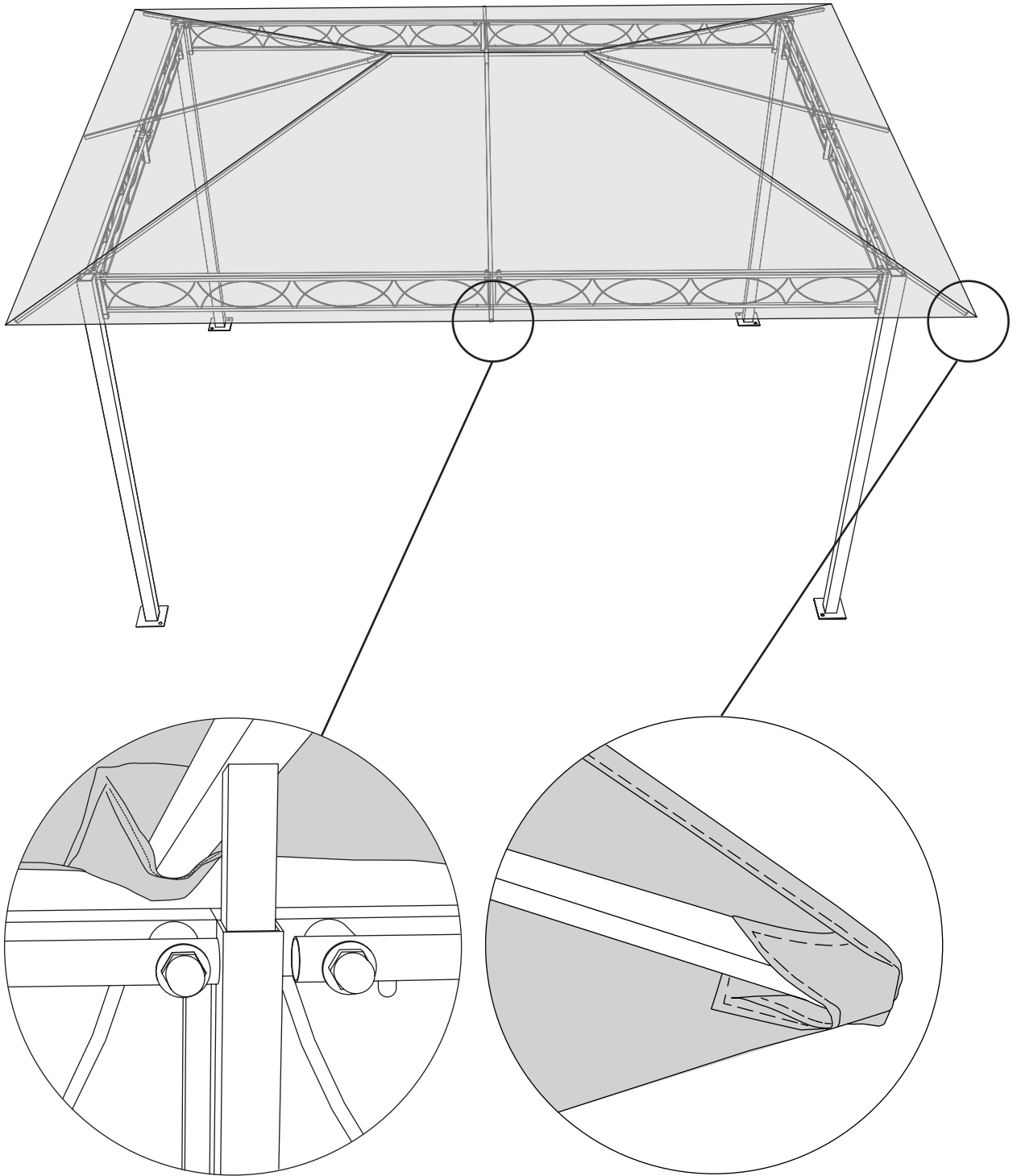

 **GG-L2-Q2 3 m x 4 m**

10

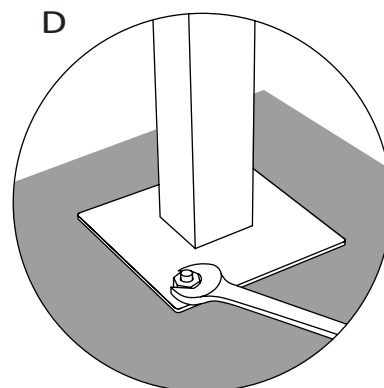
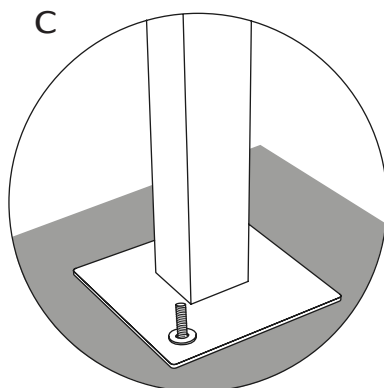
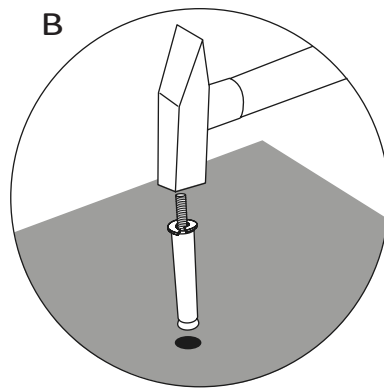
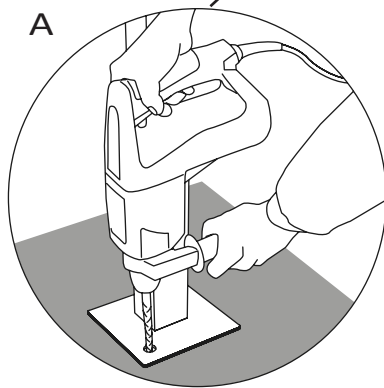
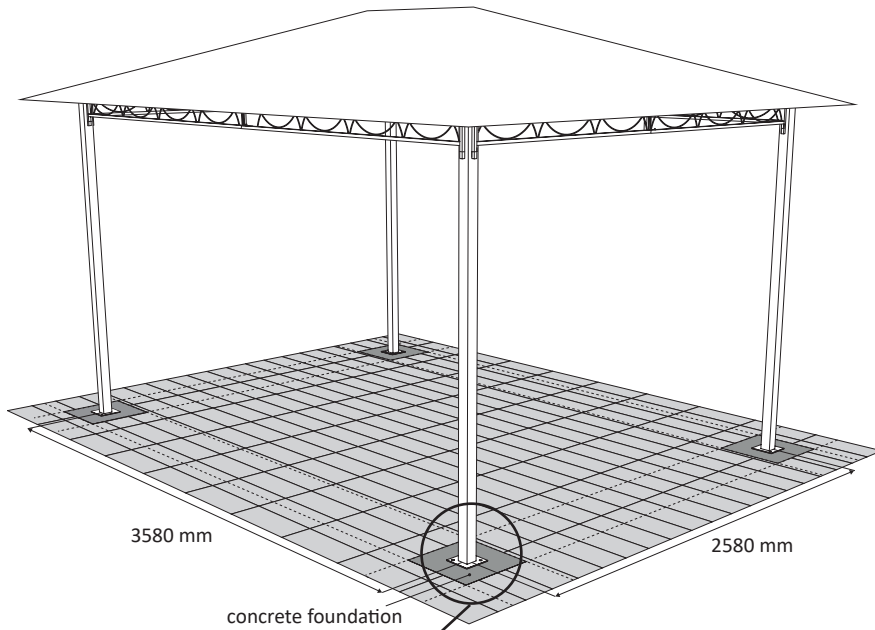
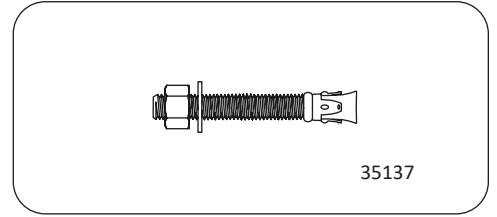

 **GG-L2-Q2** 3 m x 4 m

11

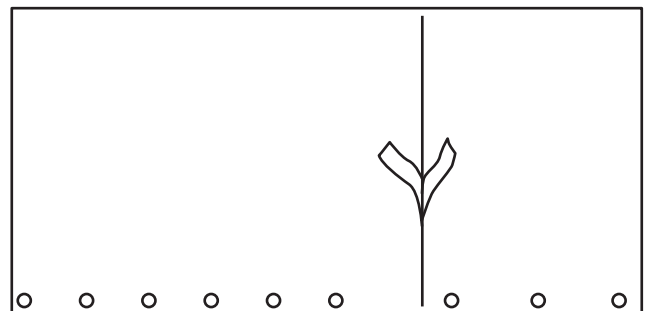
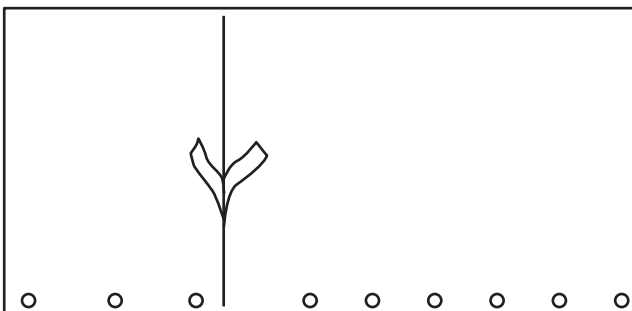
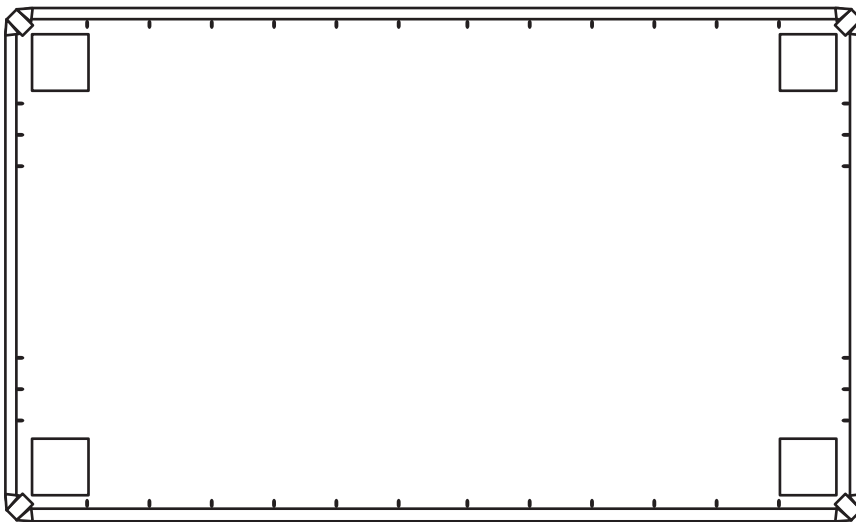
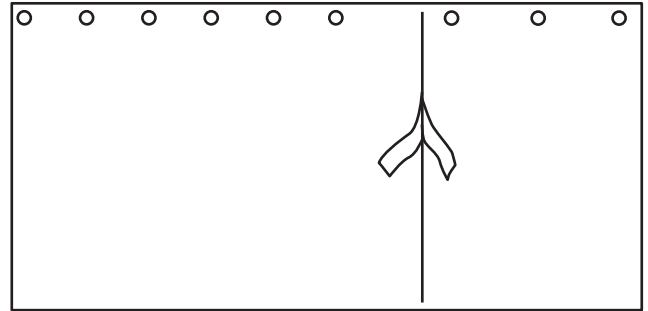
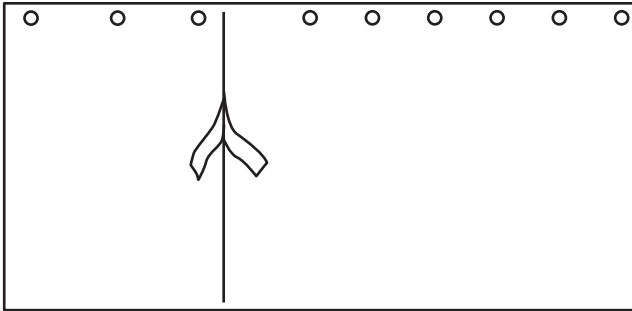
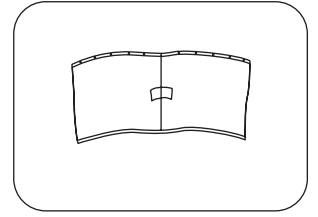

 **GG-L2-Q2 3 m x 4 m**

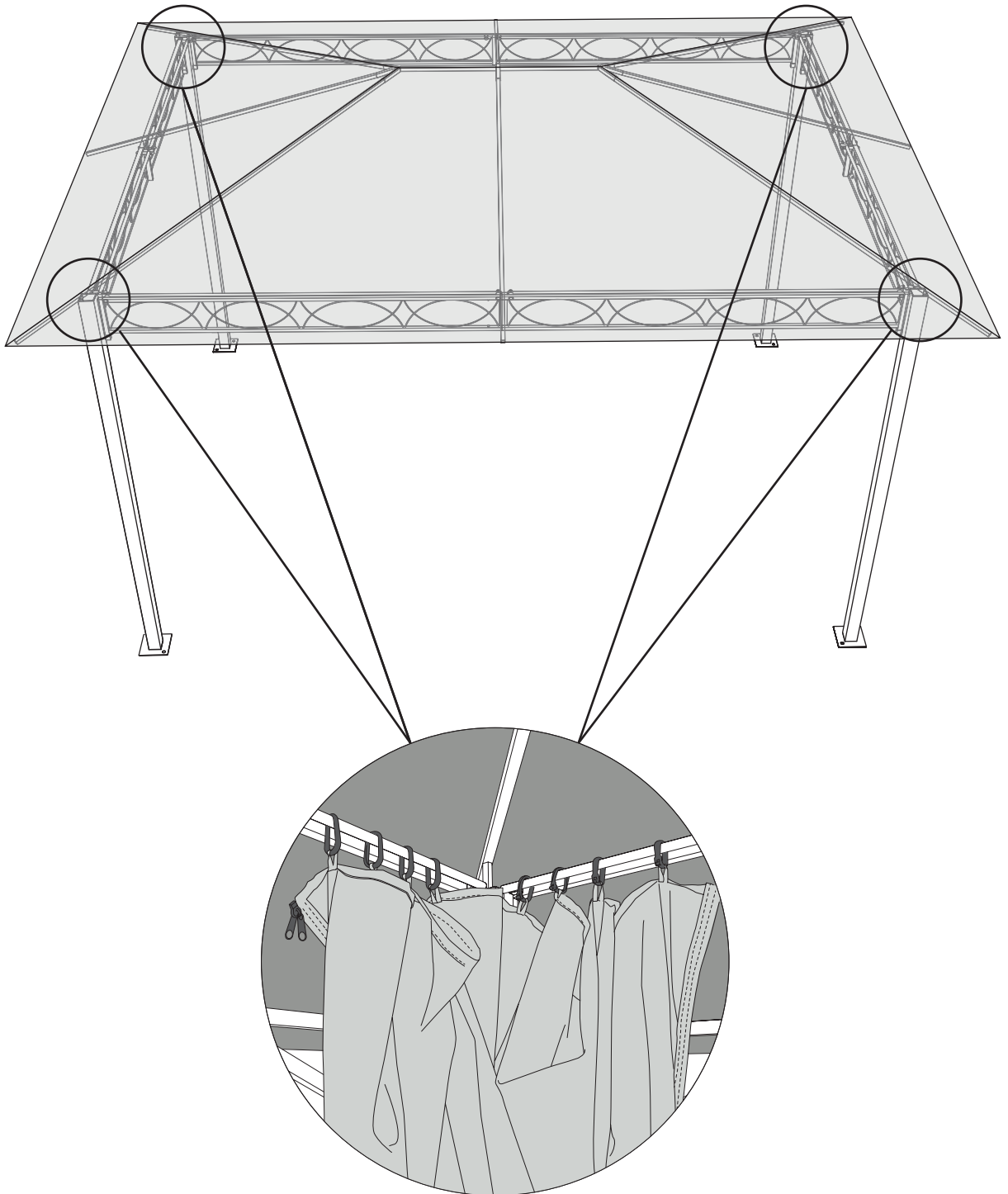
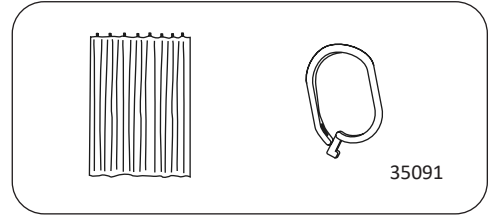



 **GG-L2-Q2 3 m x 4 m**

