 **GG-L2-Q3** 3 m x 4 m



07/2024-05

TOOLPORT

 **GG-L2-Q3 3 m x 4 m**

A

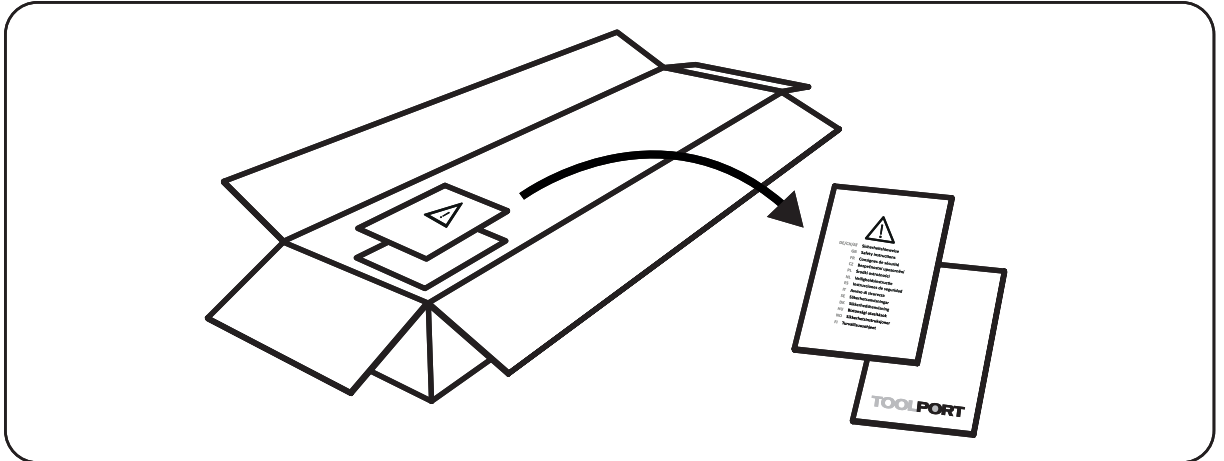



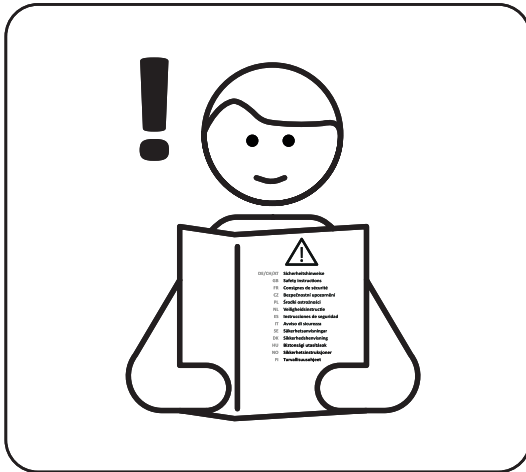



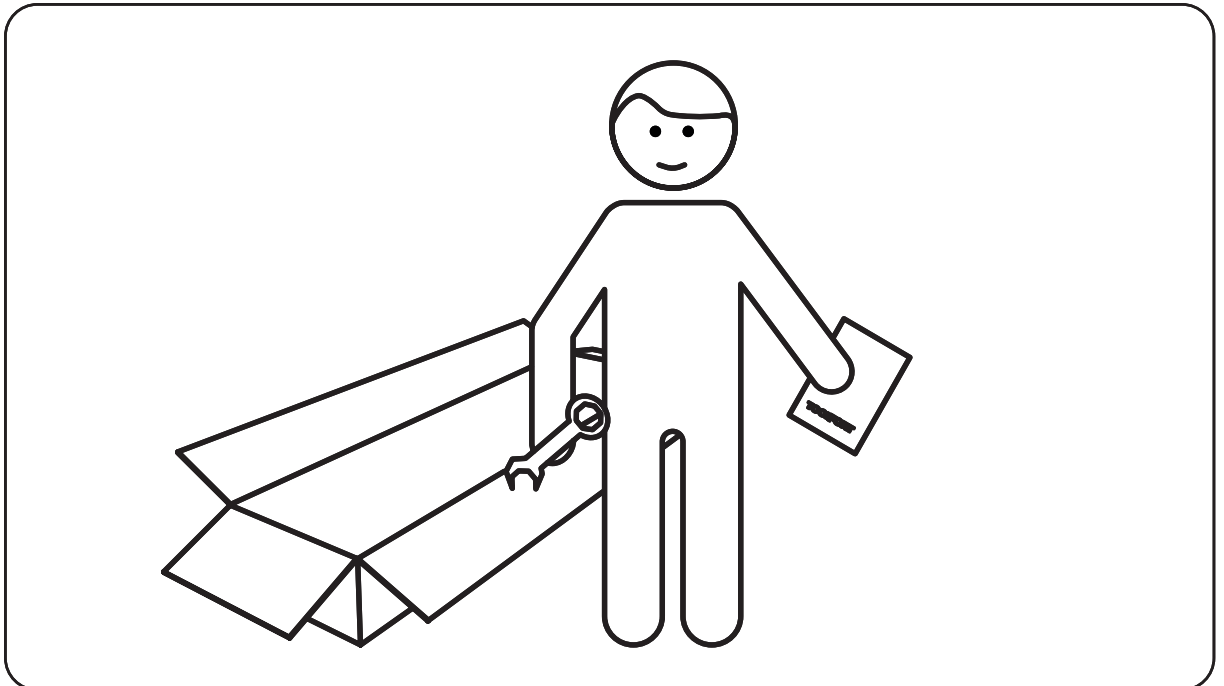



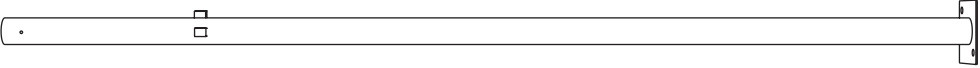

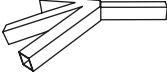
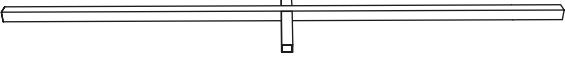
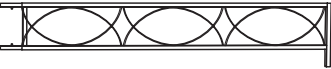

B





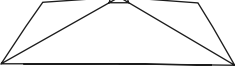





C

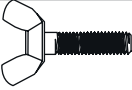

 **GG-L2-Q3 3 m x 4 m**

Item no.		Q'ty
35166		4
35167		4
35669		4
35168		4
35178		2
35177		1
35171		2
35172		2
35179		2
35180		2
35671		4
35672		4
35091		1
35091		4
35091		36
35673	M6 28 mm 	4
35285	M6 50 mm 	16

 **GG-L2-Q3 3 m x 4 m**

Item no.		Q'ty
35085	M6 15 mm 	4
35090	M6 30 mm 	8
35137		8
35670		4
35086		52
35088		20
35283		16
35154		20
35144		2
35145		1

 **GG-L2-Q3 3 m x 4 m**

1

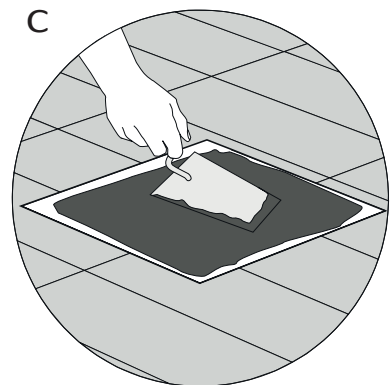
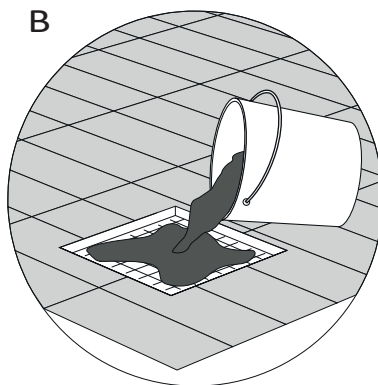
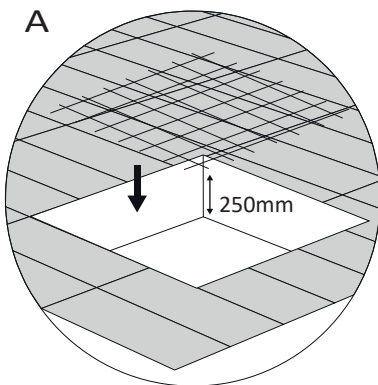
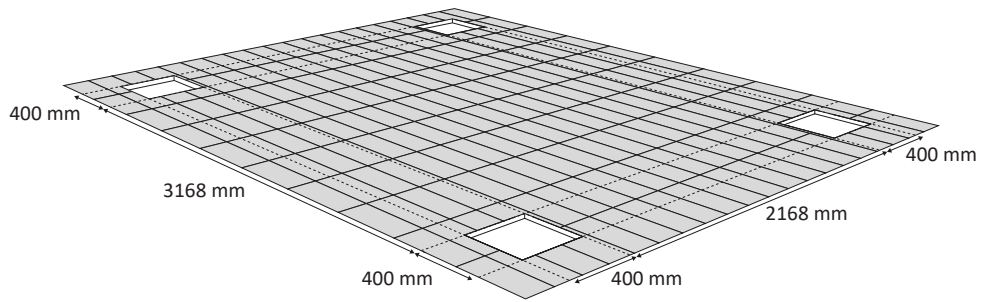
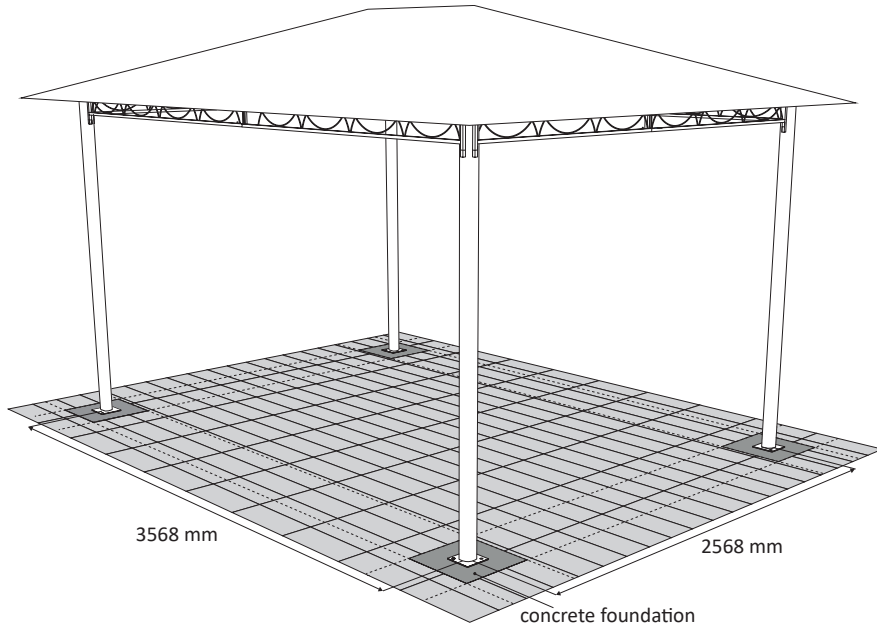

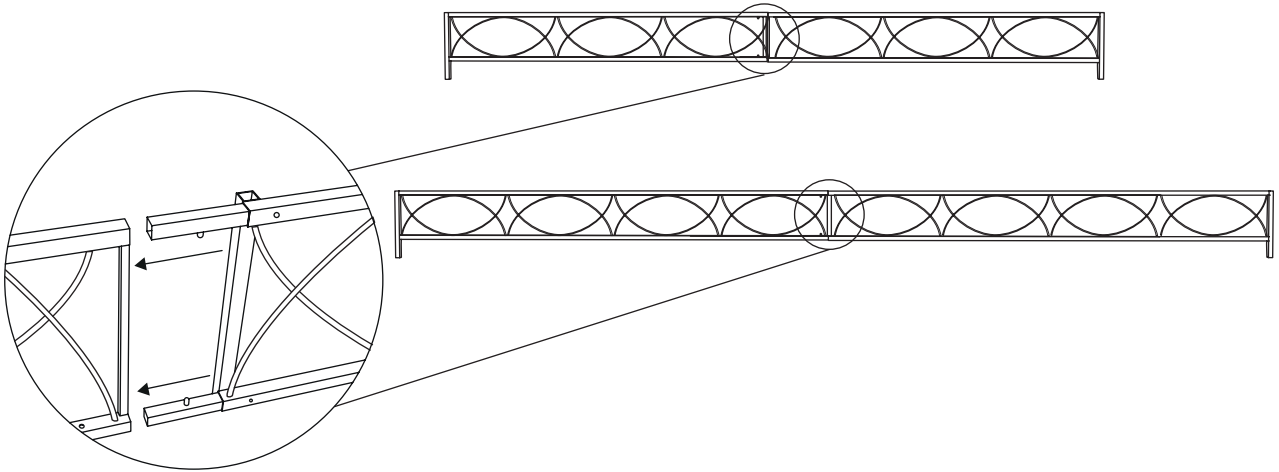
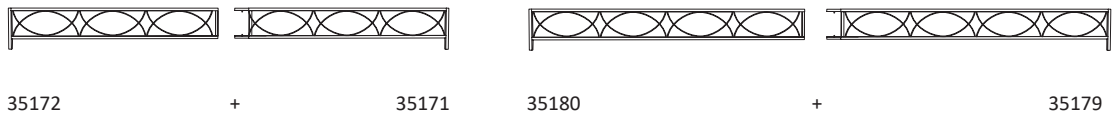

 **GG-L2-Q3 3 m x 4 m**

2



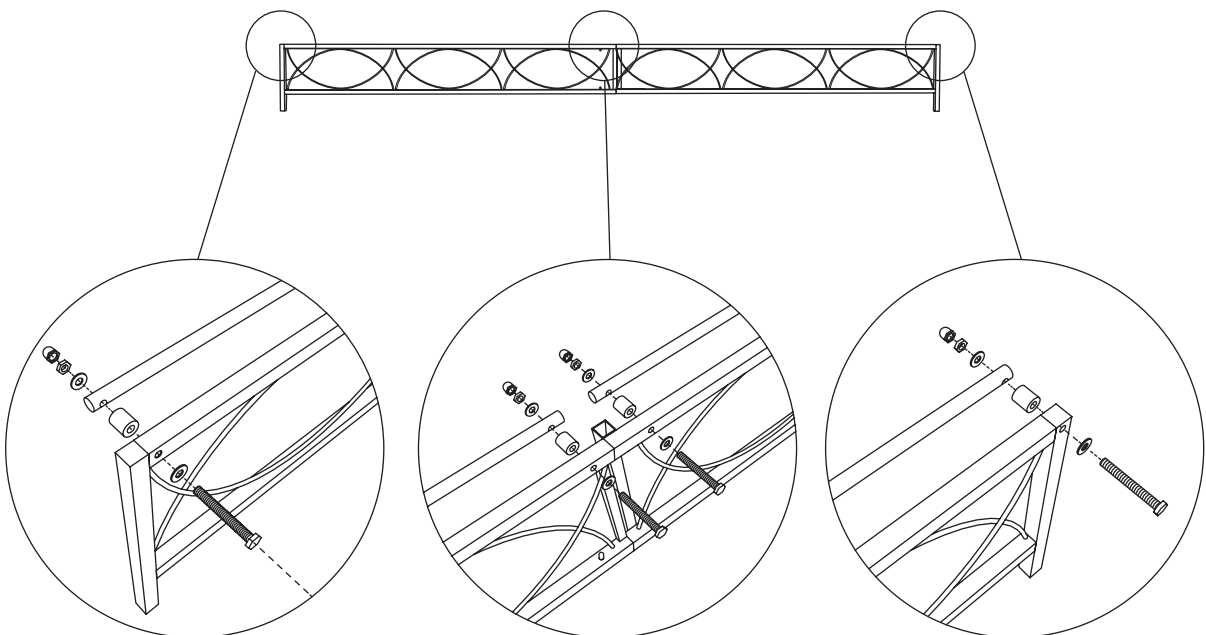
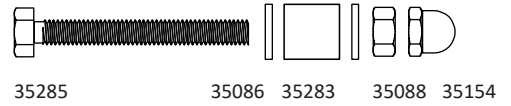
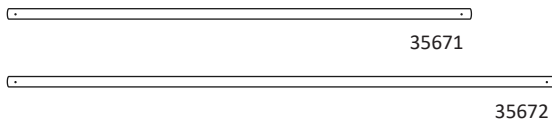

3

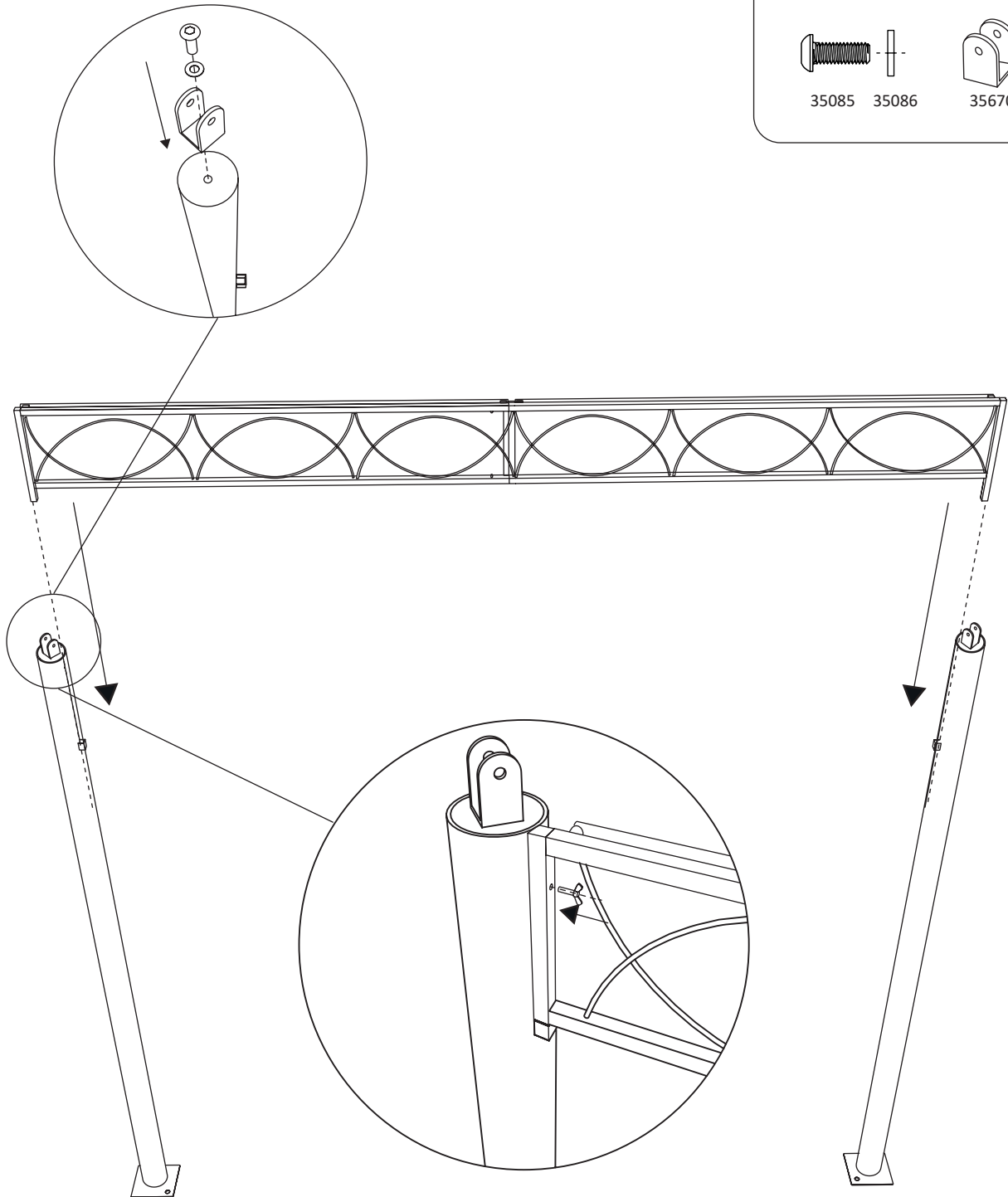
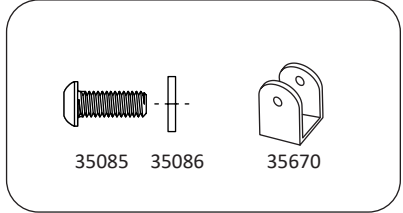
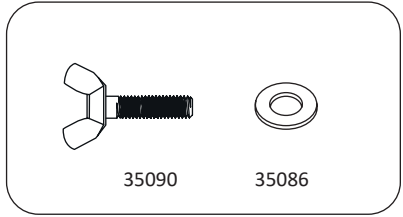
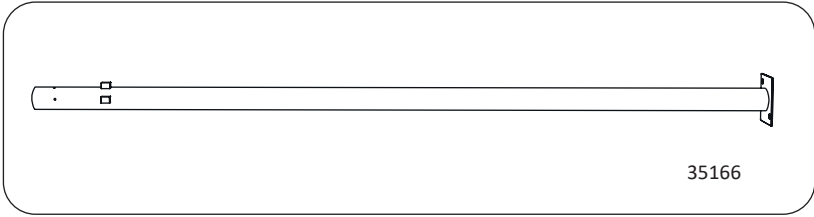

 **GG-L2-Q3 3 m x 4 m**

4



 **GG-L2-Q3 3 m x 4 m**

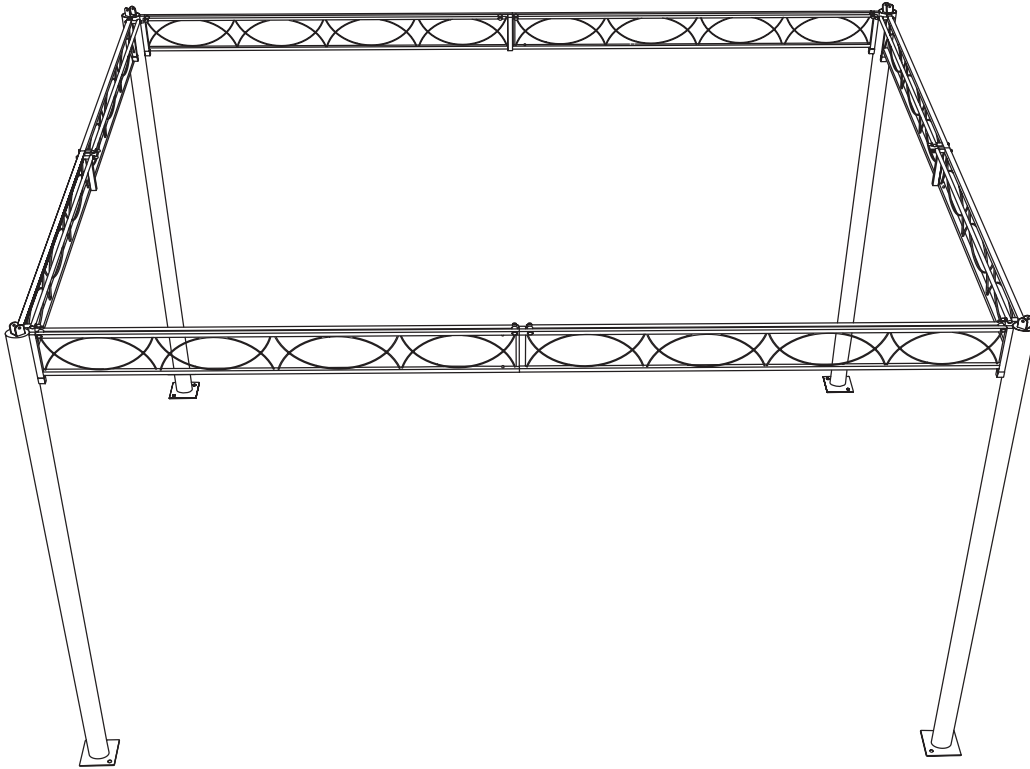

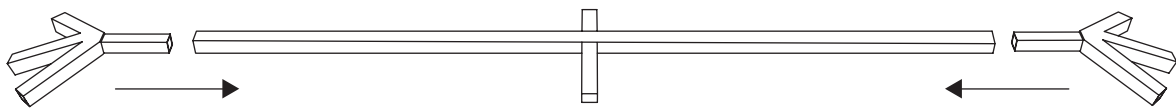
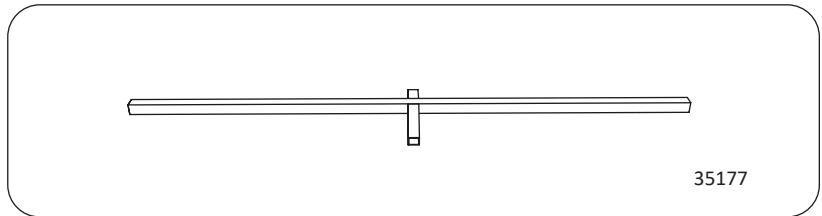
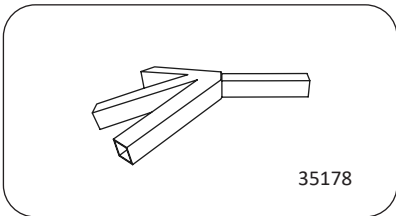

5

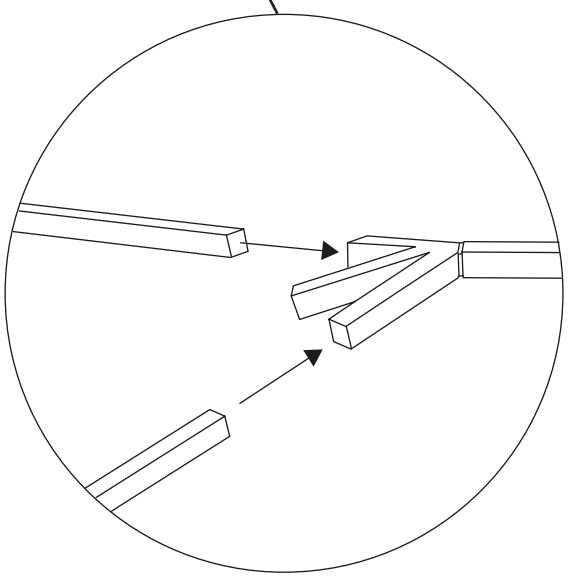
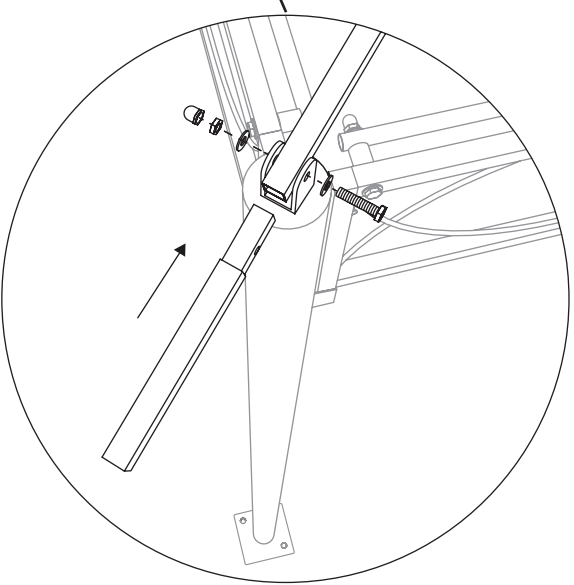
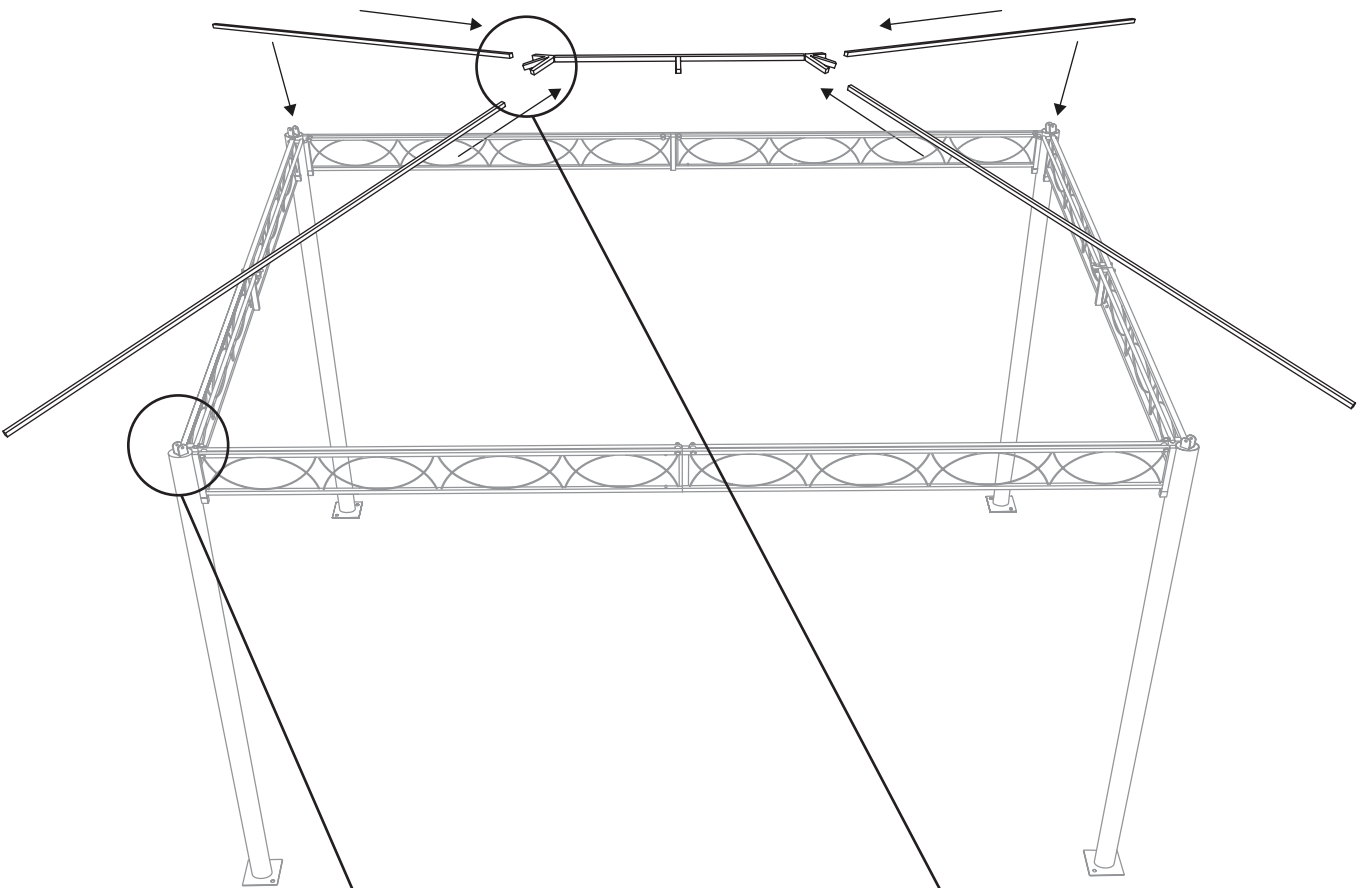
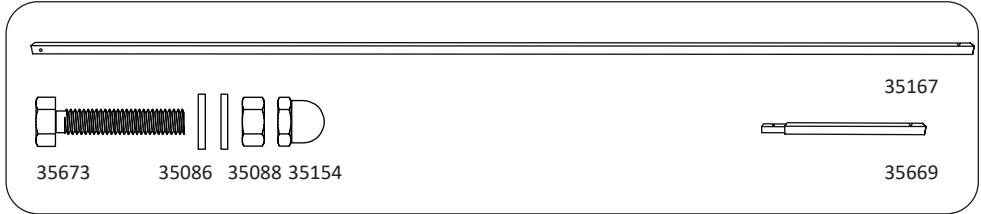

 **GG-L2-Q3 3 m x 4 m**

6



 **GG-L2-Q3 3 m x 4 m**

7

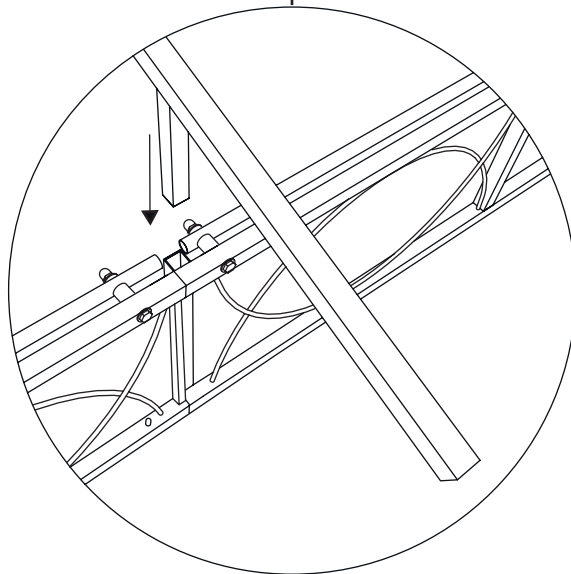
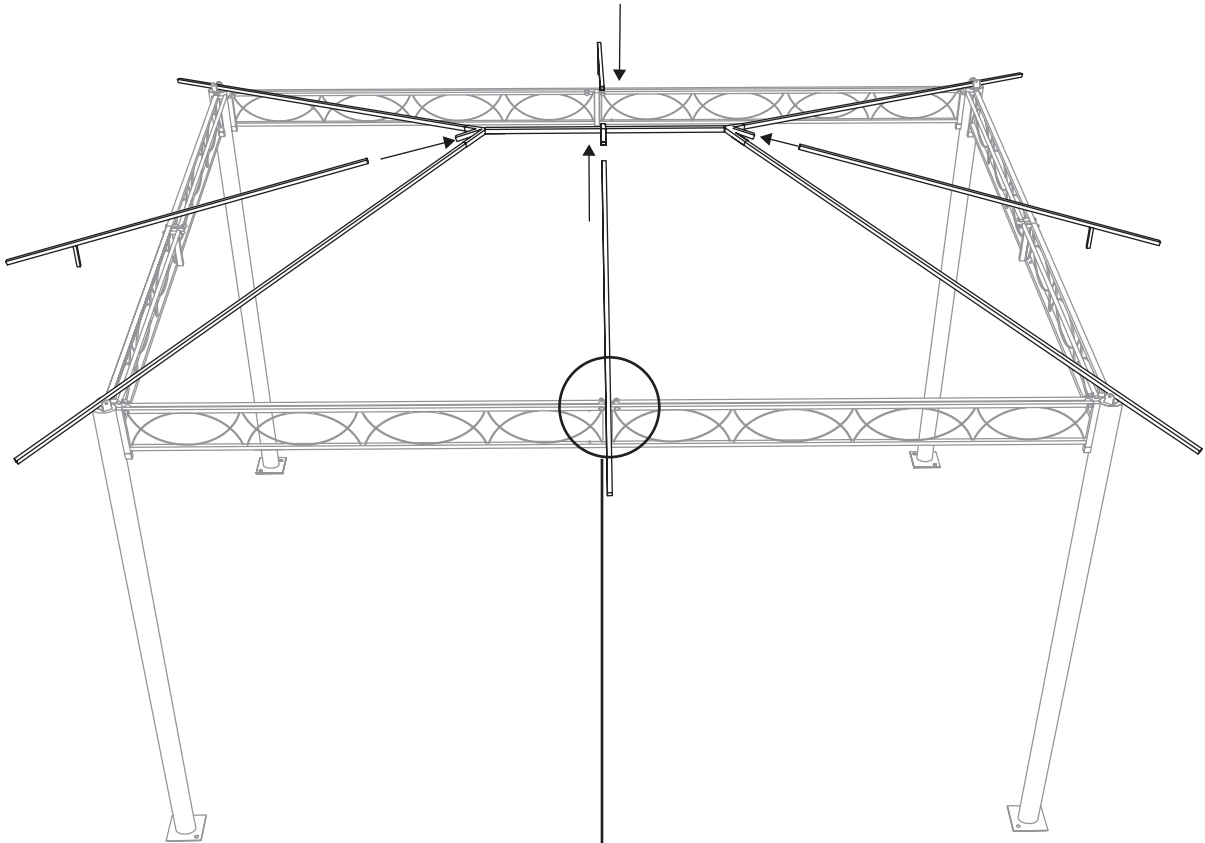
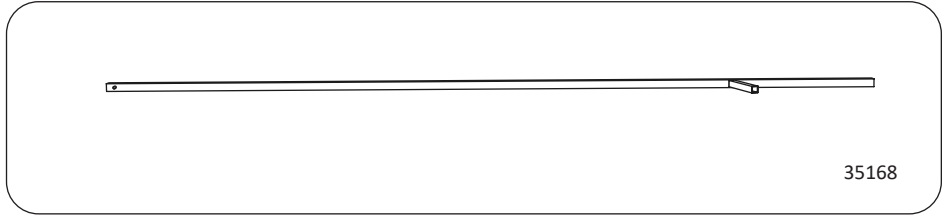

 **GG-L2-Q3 3 m x 4 m**

8

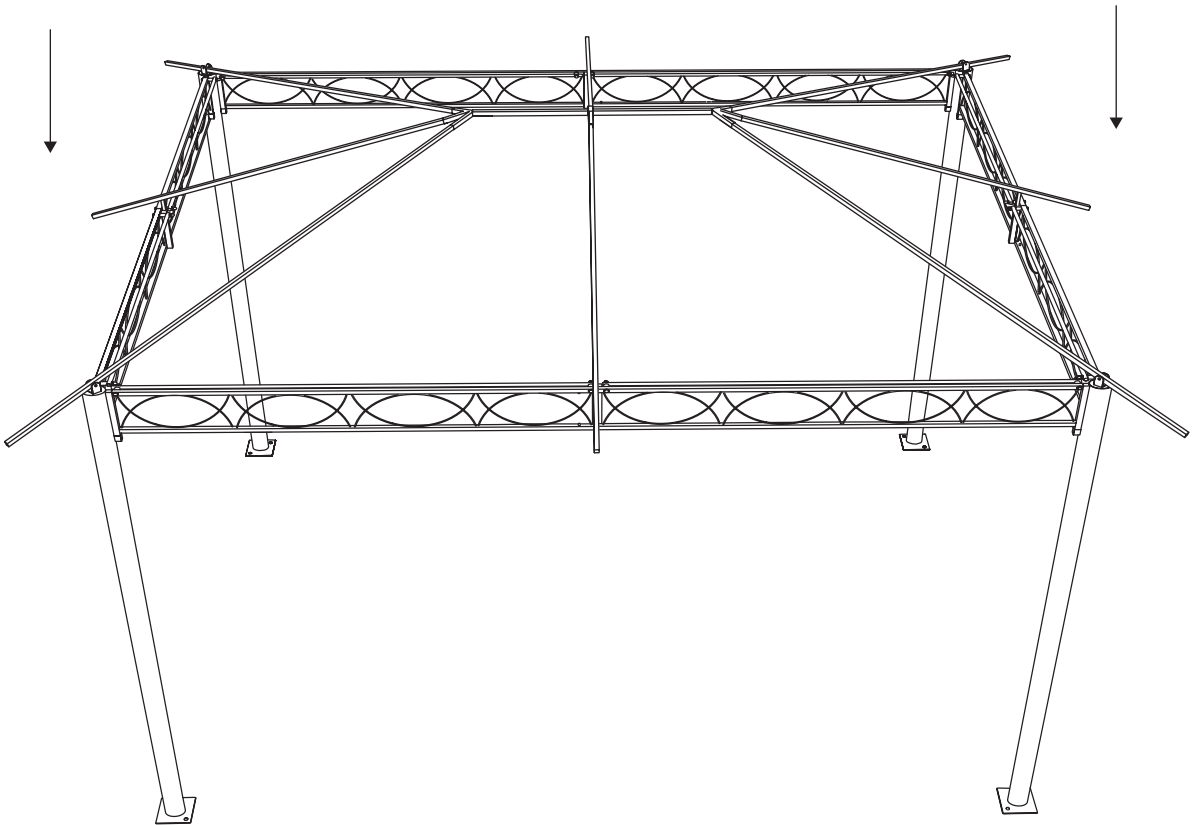
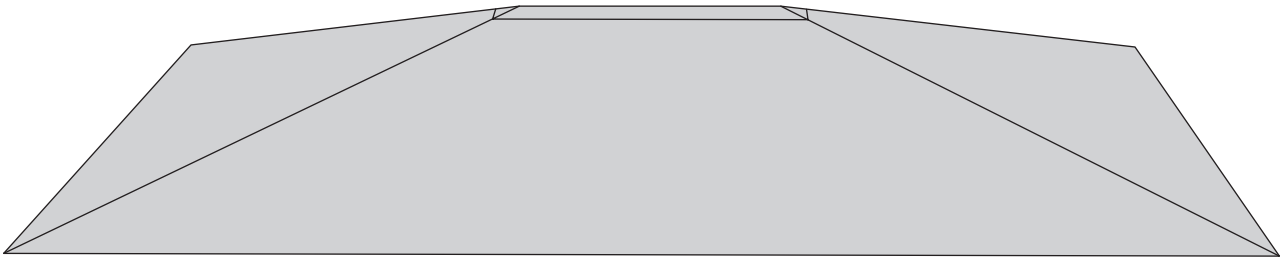
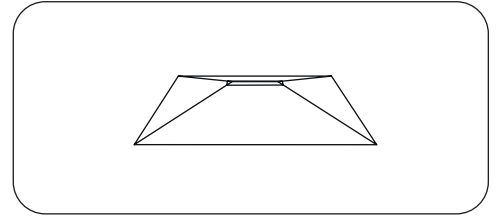

 **GG-L2-Q3 3 m x 4 m**

9

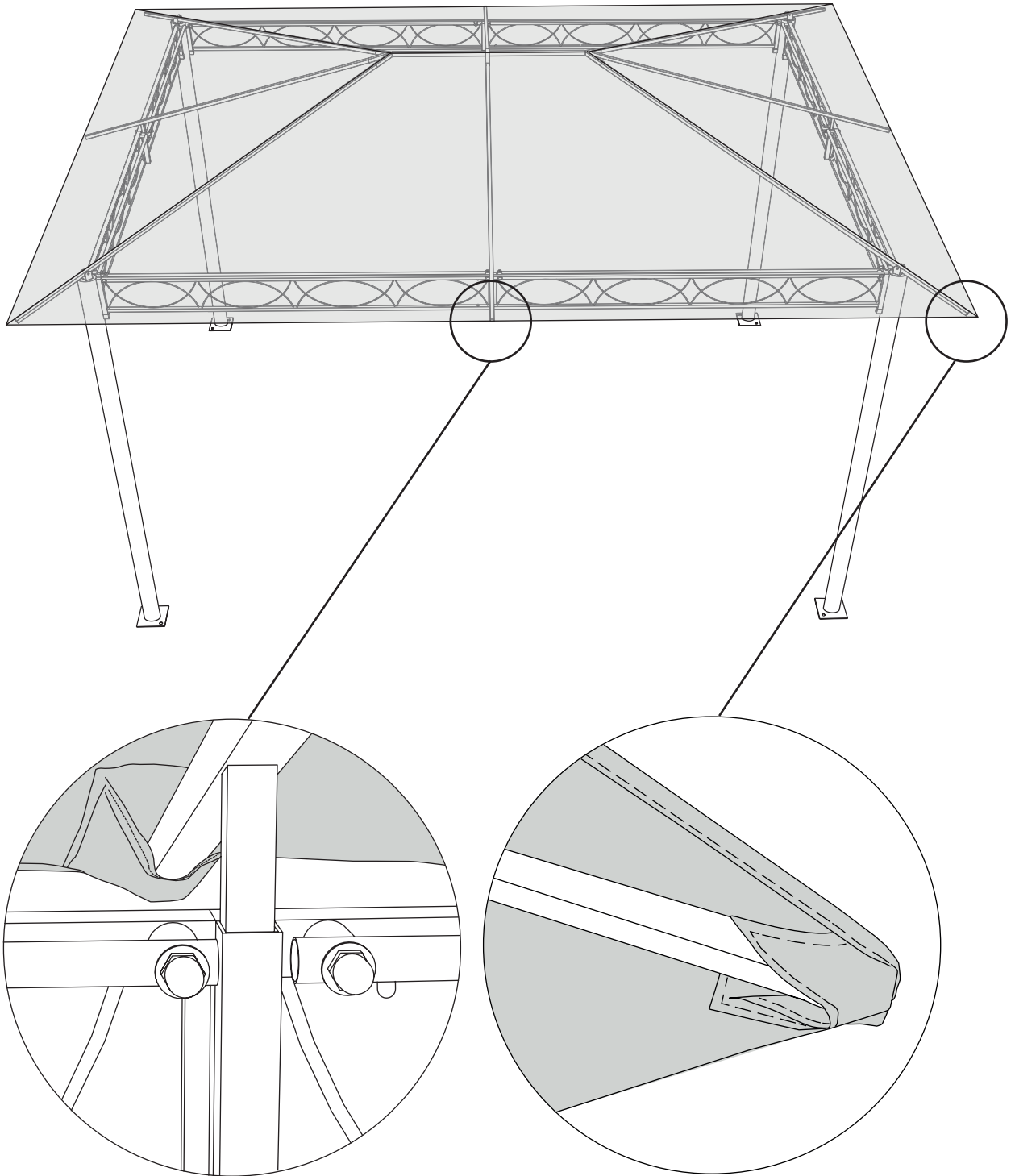

 **GG-L2-Q3 3 m x 4 m**

10

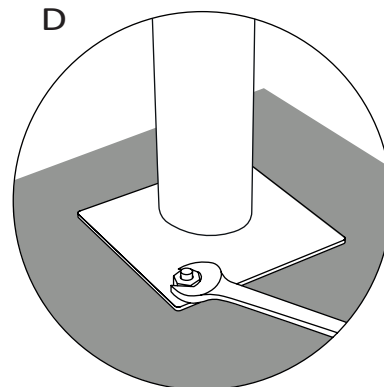
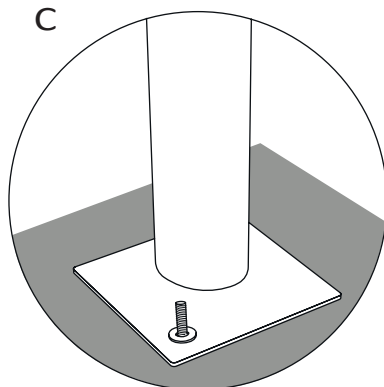
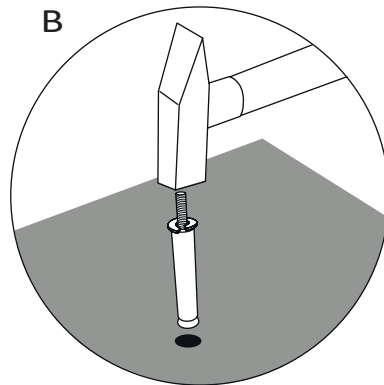
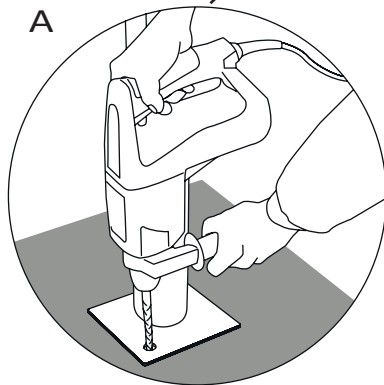
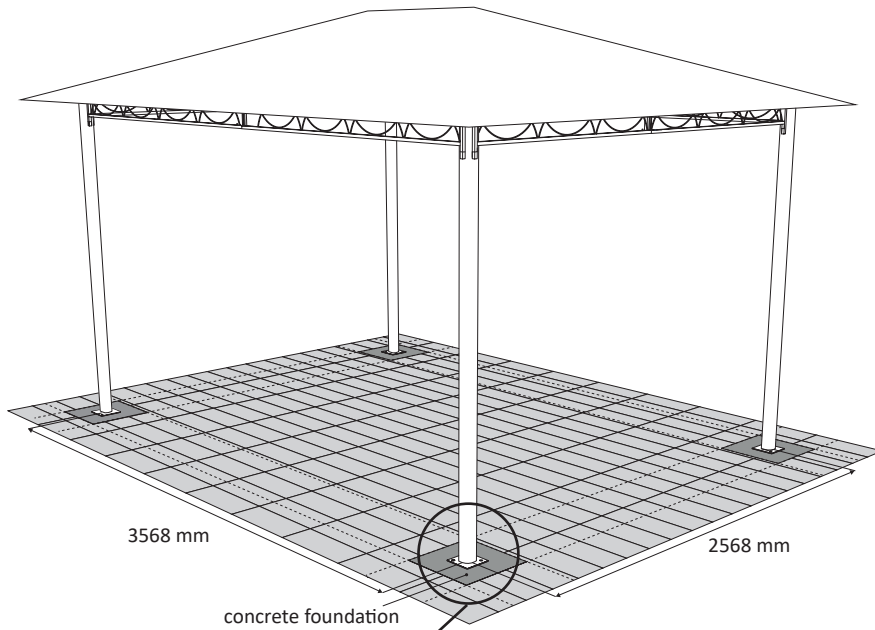
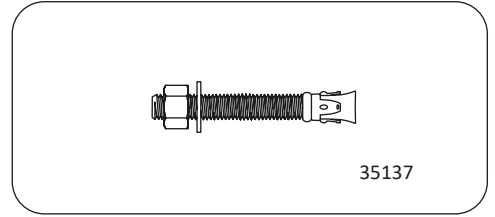

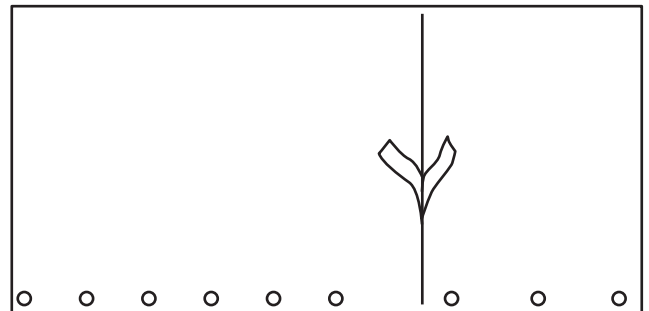
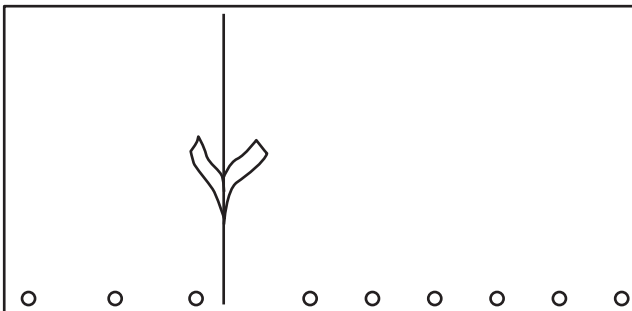
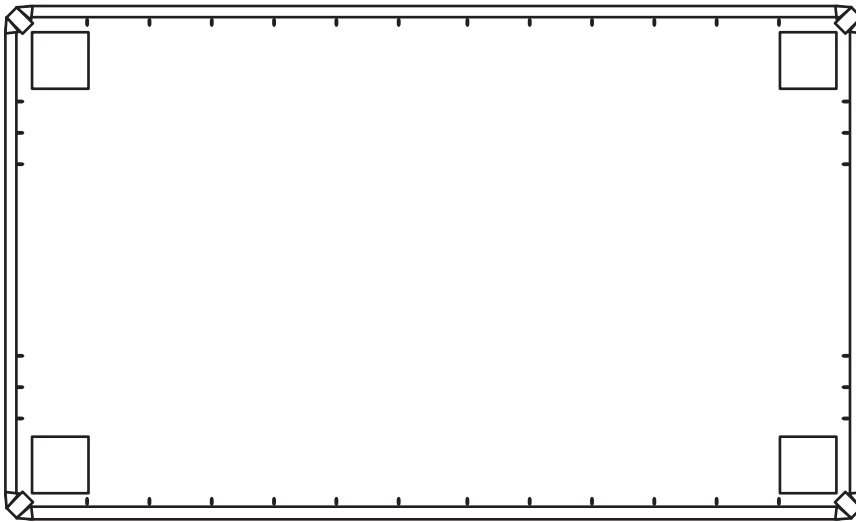
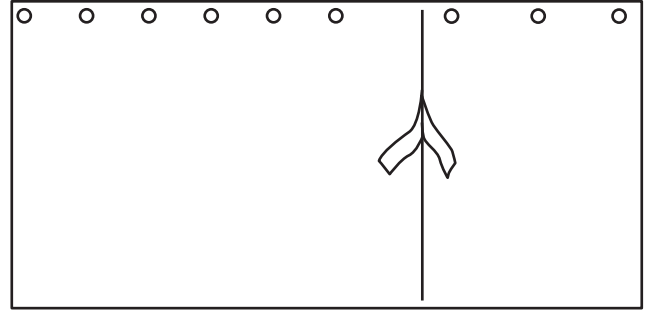
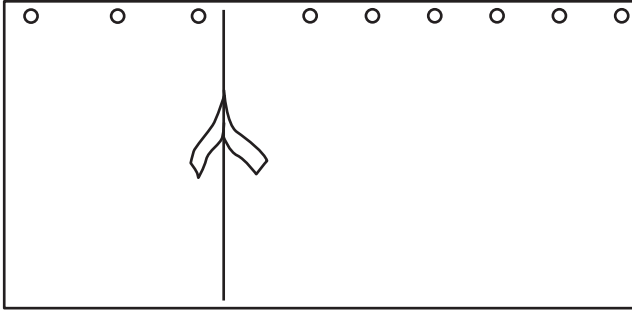
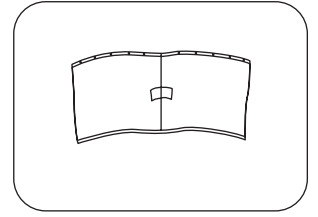

 **GG-L2-Q3** 3 m x 4 m

11

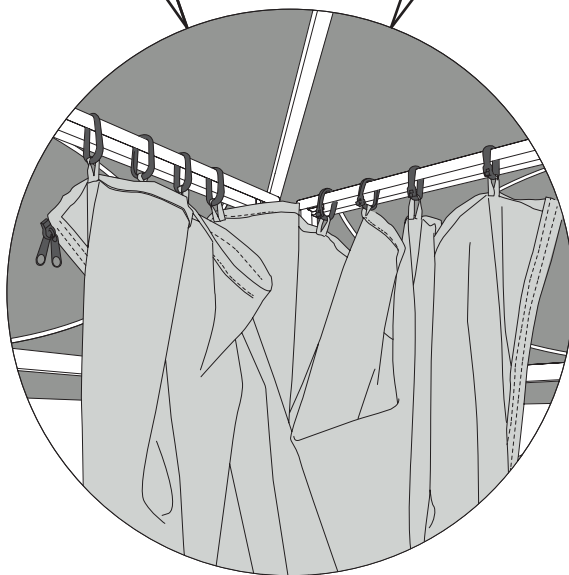
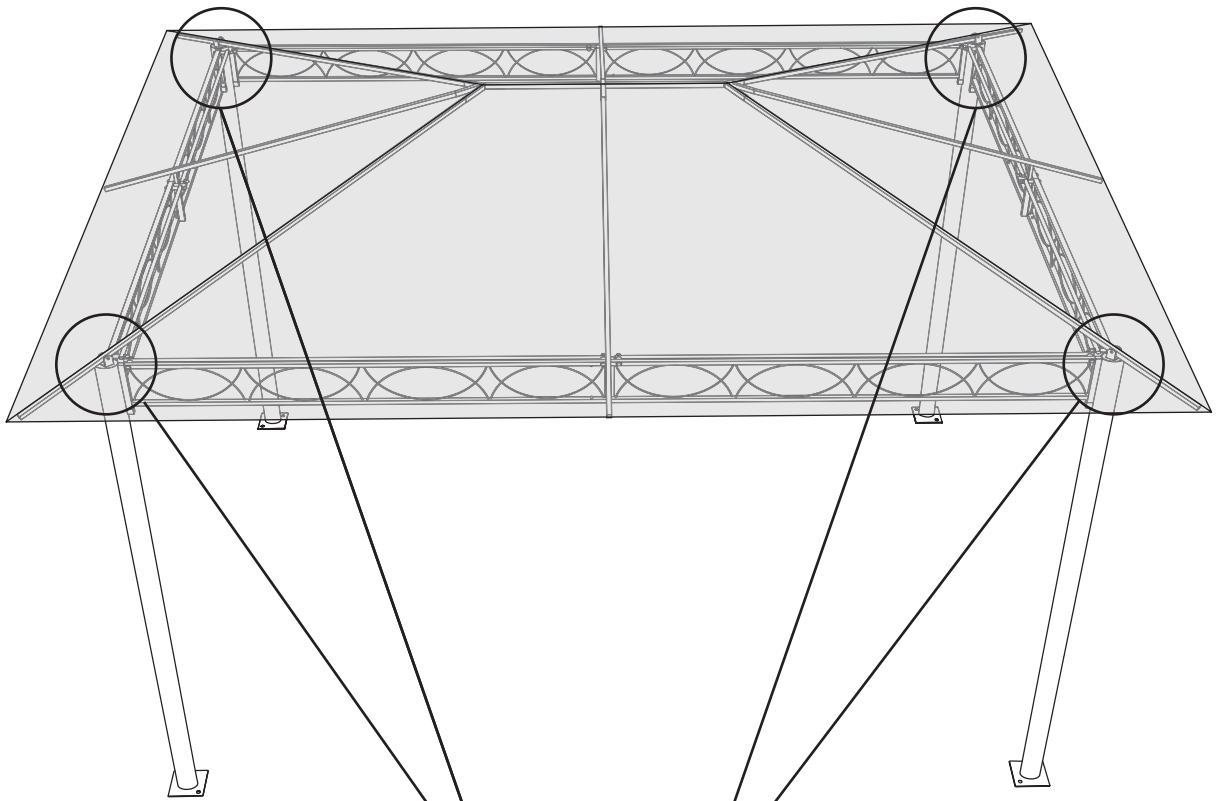
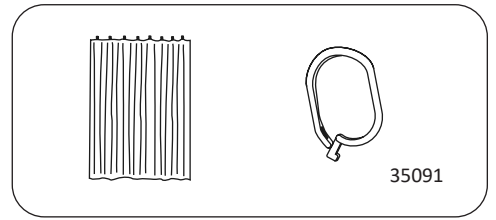

 **GG-L2-Q3 3 m x 4 m**



 **GG-L2-Q3 3 m x 4 m**

