

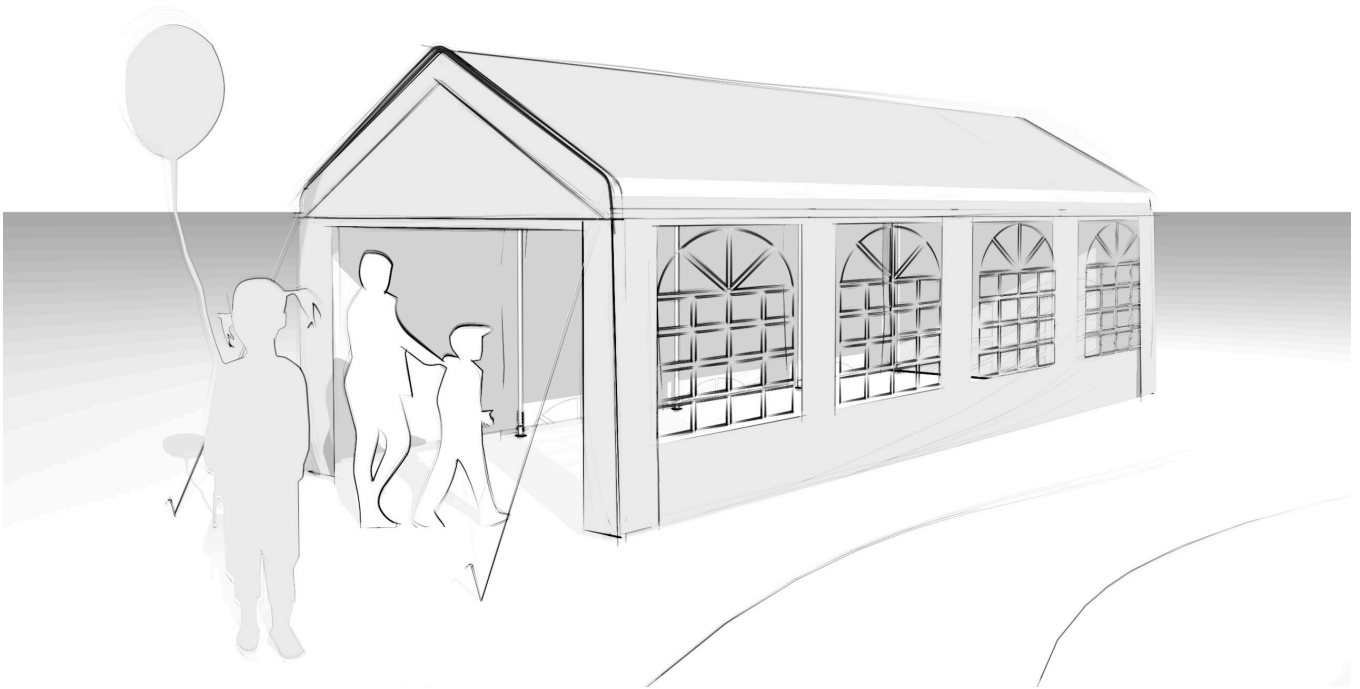

**PT-L1-Q3** 4 m x 6 m, 4 m x 8 m, 4 m x 10 m



07/2024-04

# TOOLPORT





**PT-L1-Q3** 4 m x 6 m, 4 m x 8 m, 4 m x 10 m

**A**

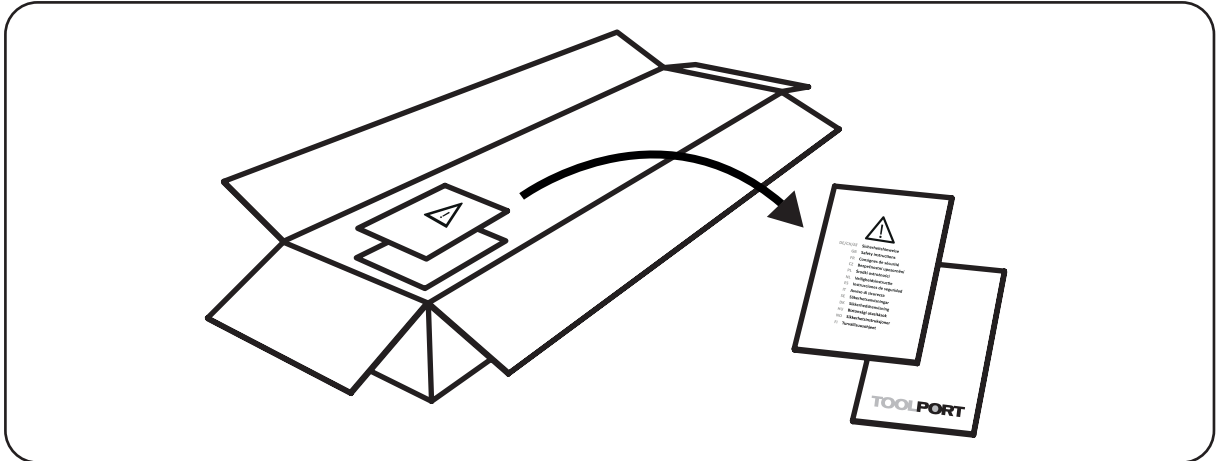

**B**

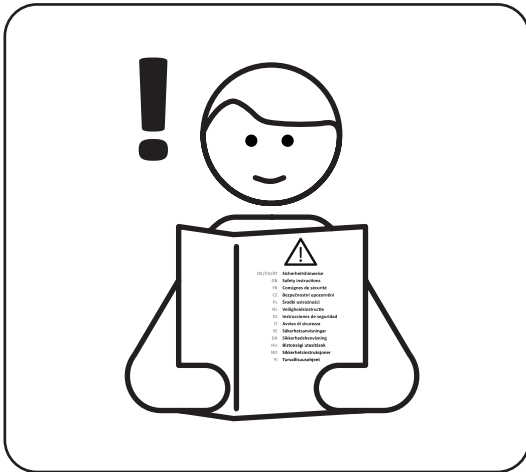



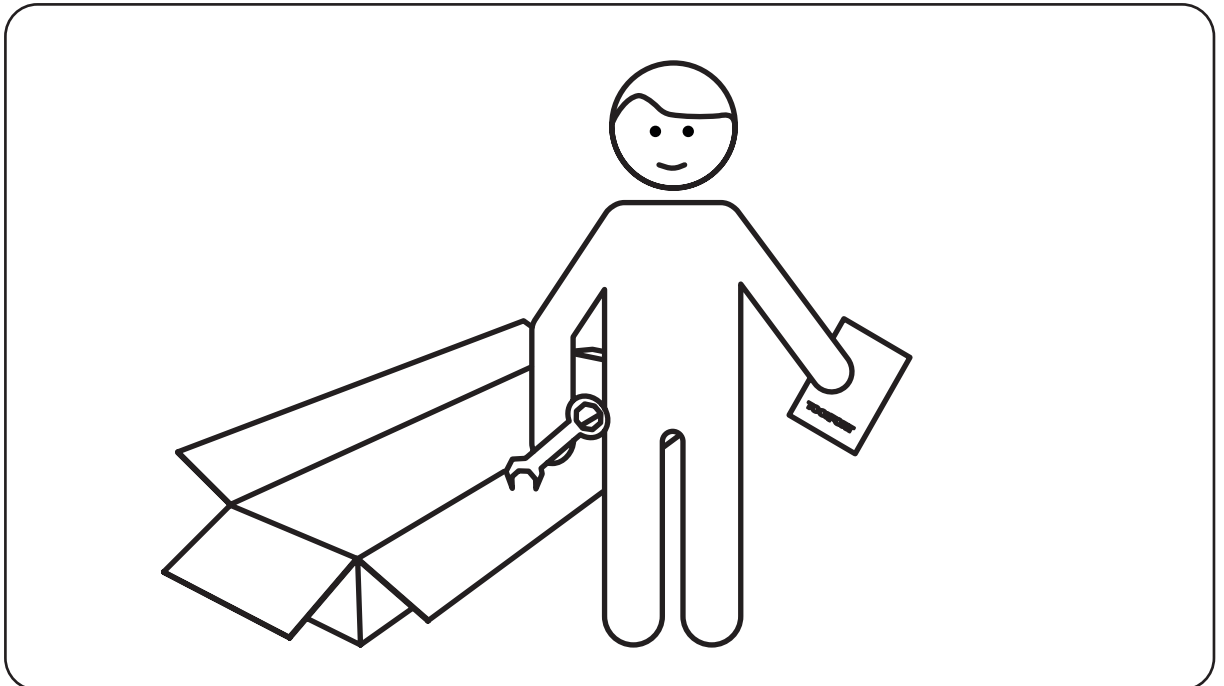





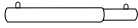

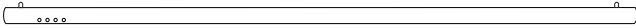
**C**

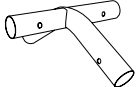

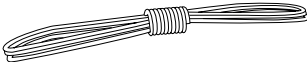

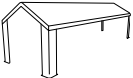
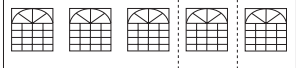
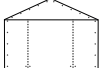
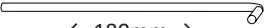
# PT-L1-Q3 4 m x 6 m, 4 m x 8 m, 4 m x 10 m

Item no.		6 m	8 m	10 m
33059	 Ø38mm ← 257mm →	8	10	12
33060	 Ø38mm ← 1930mm →	9	12	15
33094	 Ø38mm ← 1930mm →	8	10	12
33057	 Ø38mm ← 1895mm →	8	10	12
33079		8	10	12
33062		6	6	6
33063		6	9	12
30430		68	76	84
30050		4	4	4
30051		4	4	4
		1	1	1
		2	2	2
		2	2	2
30046	 ← 180mm →	4	4	4
30047	 ← 160mm →	24	28	32



# PT-L1-Q3 4 m x 6 m, 4 m x 8 m, 4 m x 10 m

1

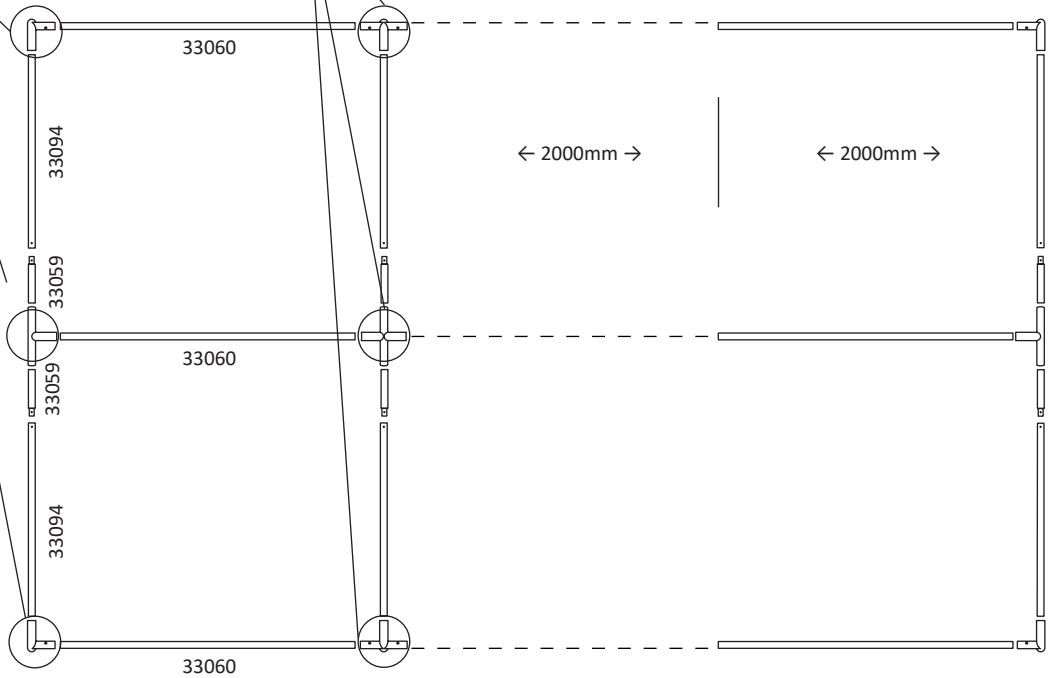
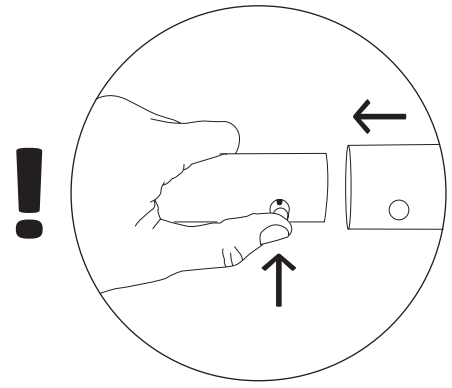
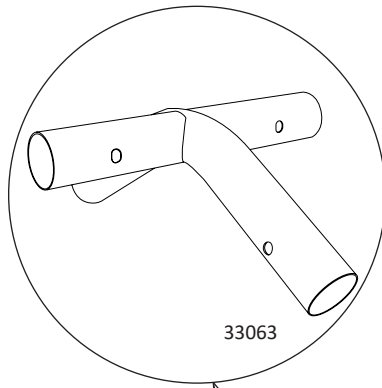
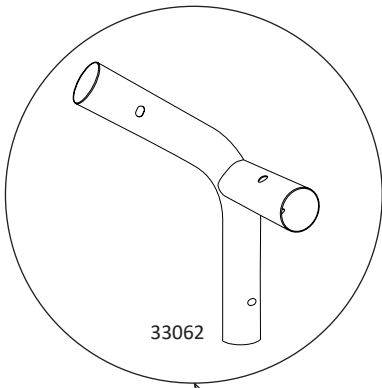
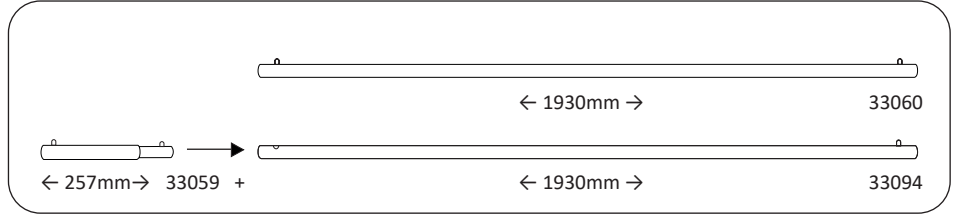



# PT-L1-Q3 4 m x 6 m, 4 m x 8 m, 4 m x 10 m

2

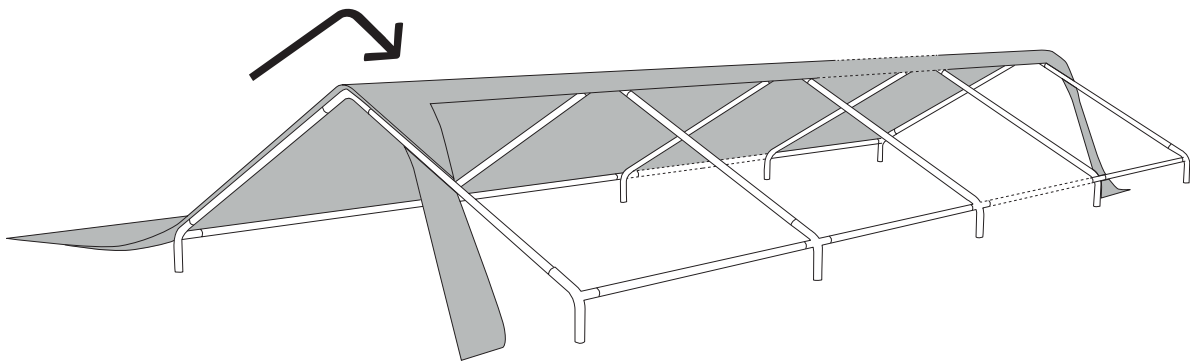
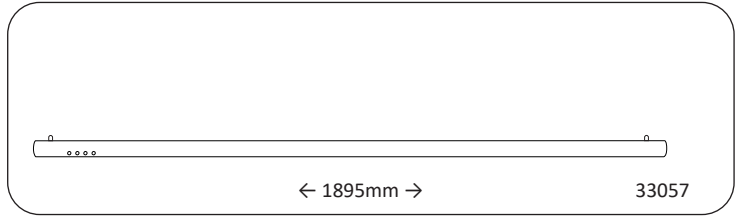
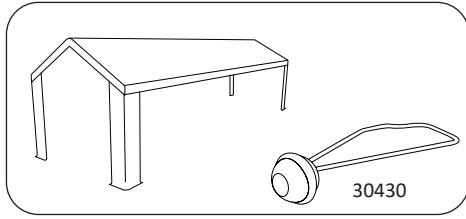

3

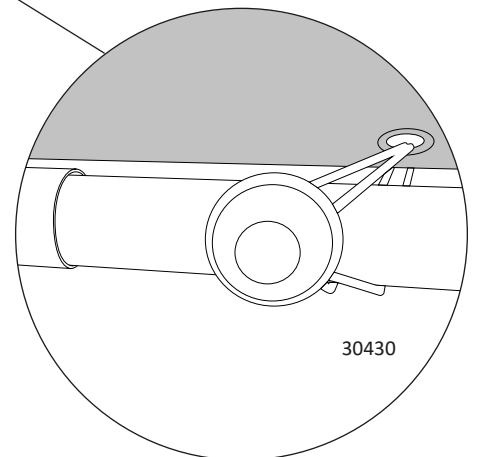
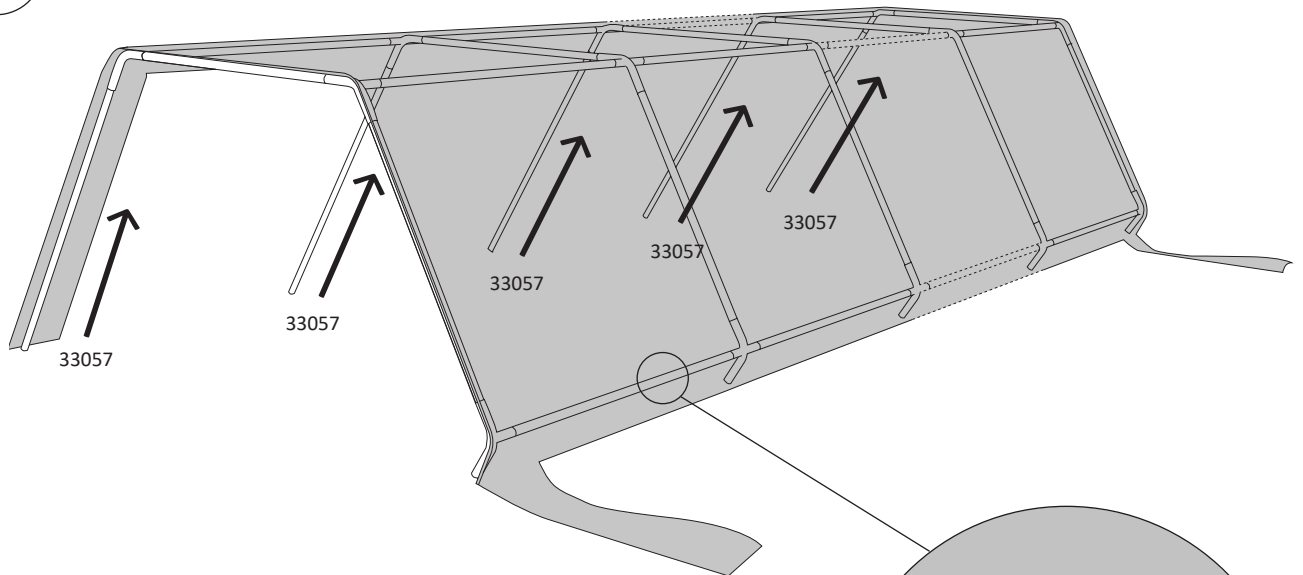



# PT-L1-Q3 4 m x 6 m, 4 m x 8 m, 4 m x 10 m

4

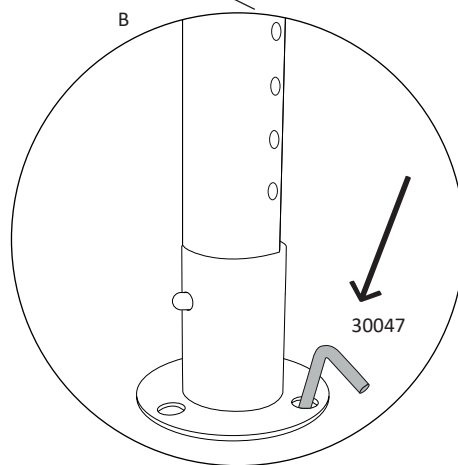
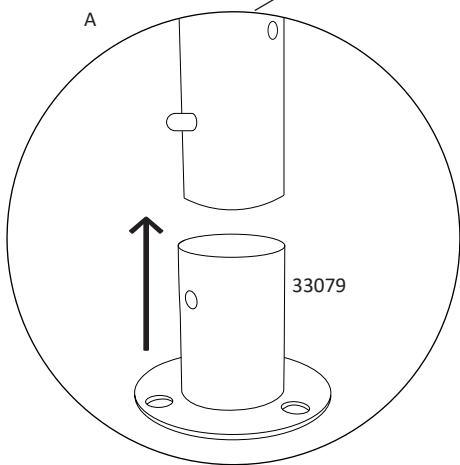
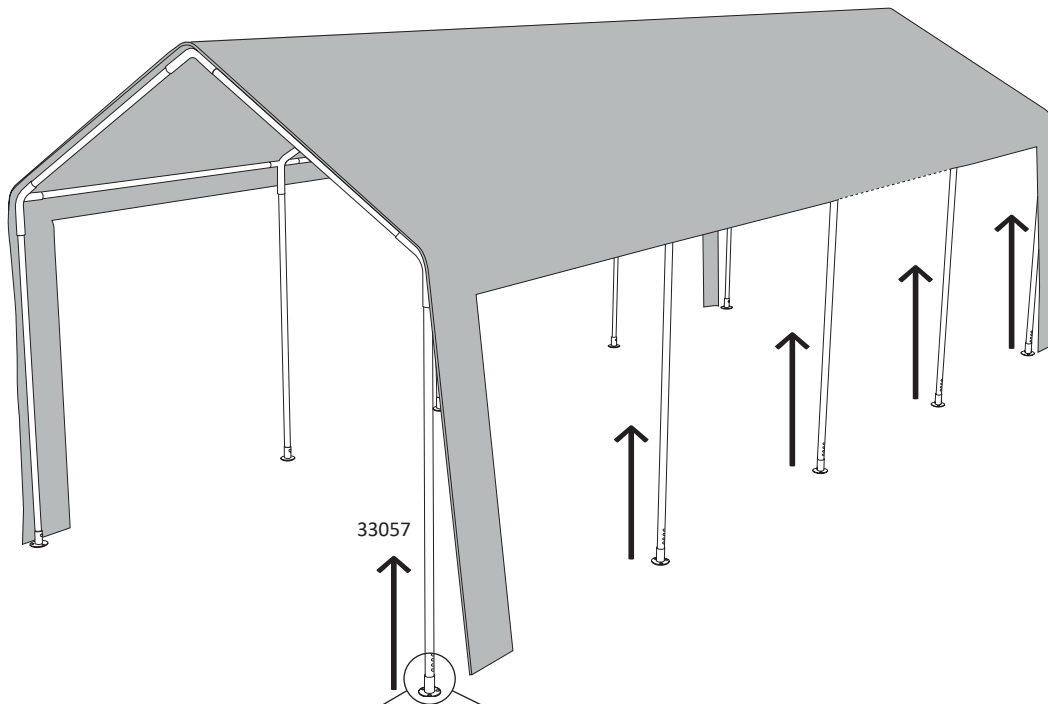
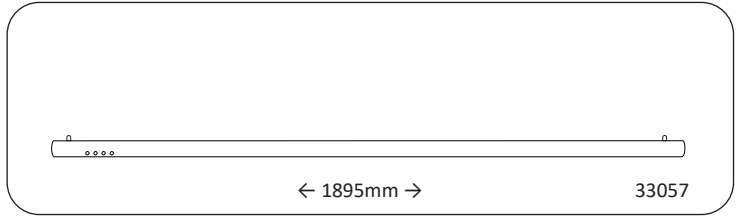
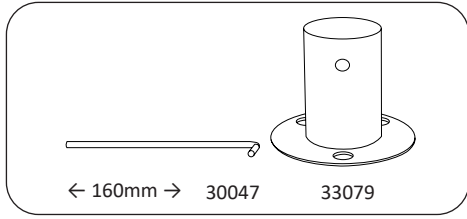



# PT-L1-Q3 4 m x 6 m, 4 m x 8 m, 4 m x 10 m

5

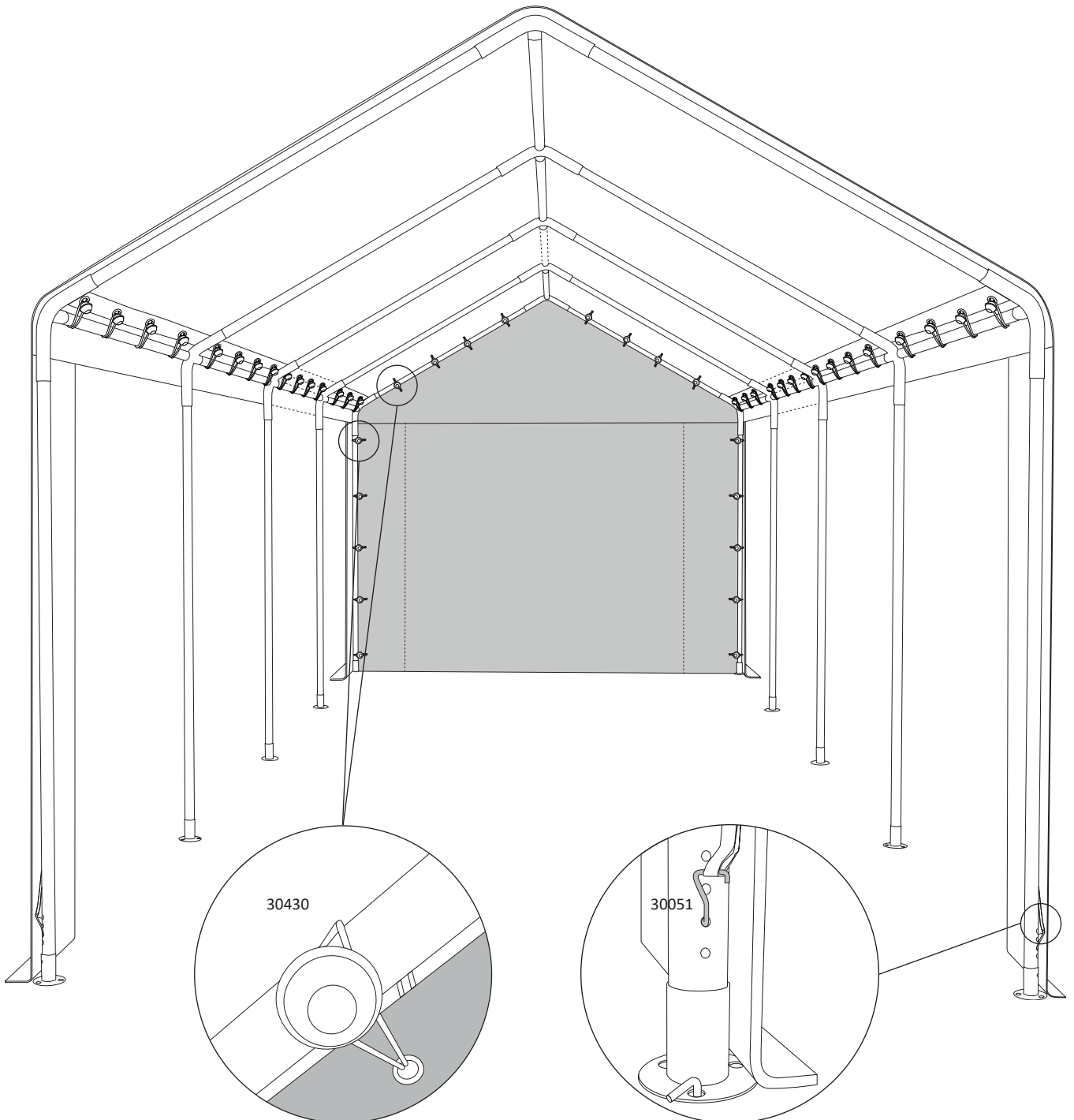
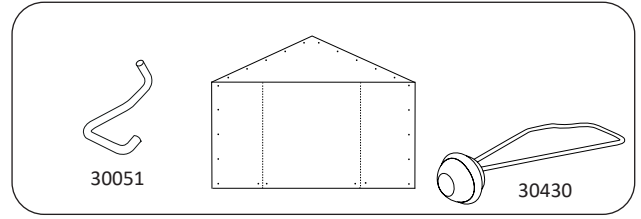





**PT-L1-Q3** 4 m x 6 m, 4 m x 8 m, 4 m x 10 m

6

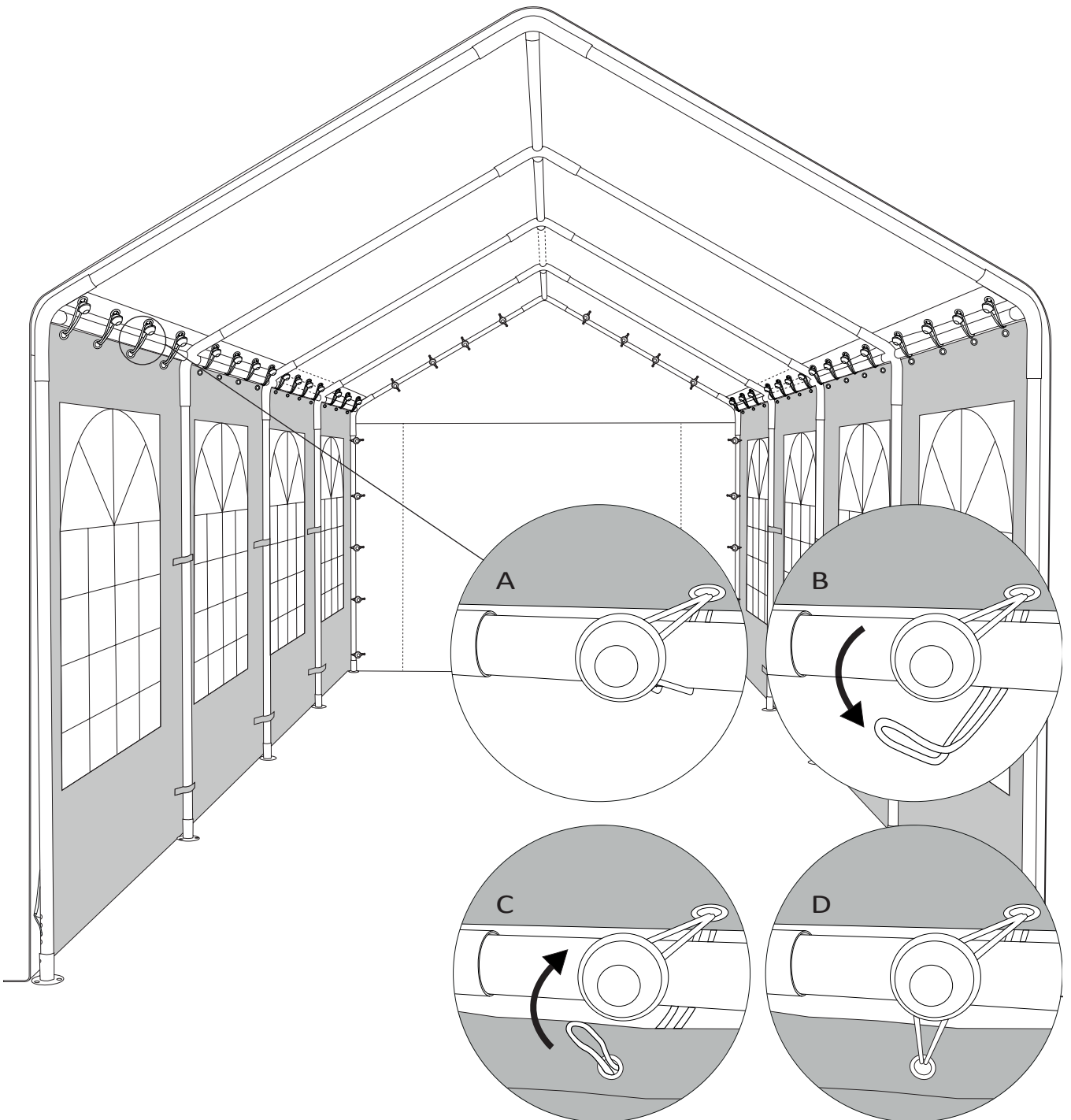
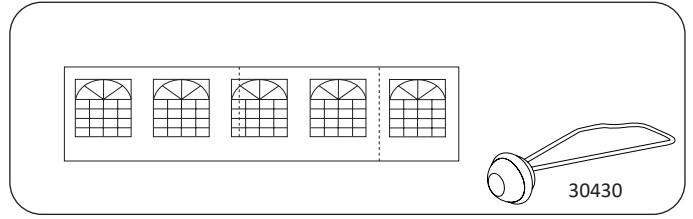



# PT-L1-Q3 4 m x 6 m, 4 m x 8 m, 4 m x 10 m

7

