

**PT-L2-Q1-2.6** 4 m x 6 m, 4 m x 8 m, 4 m x 10 m

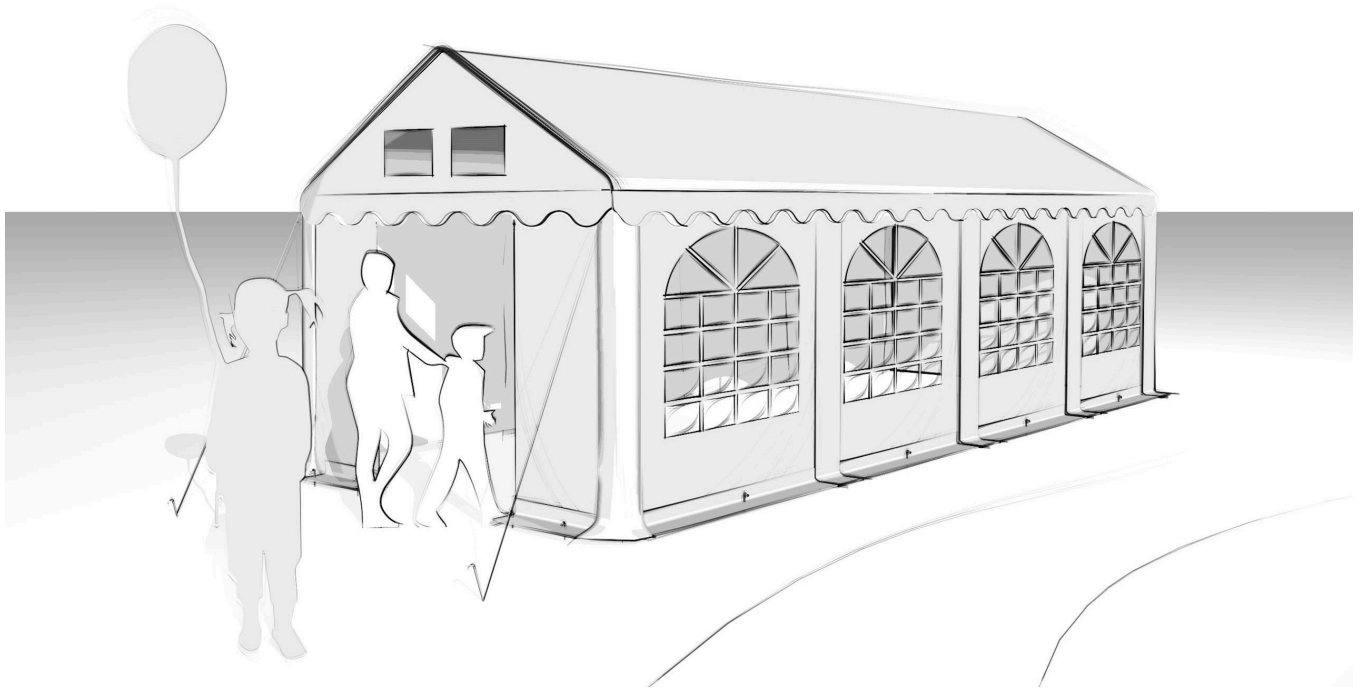

07/2024-03

# TOOLPORT



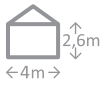

**PT-L2-Q1-2.6** 4 m x 6 m, 4 m x 8 m, 4 m x 10 m

**A**

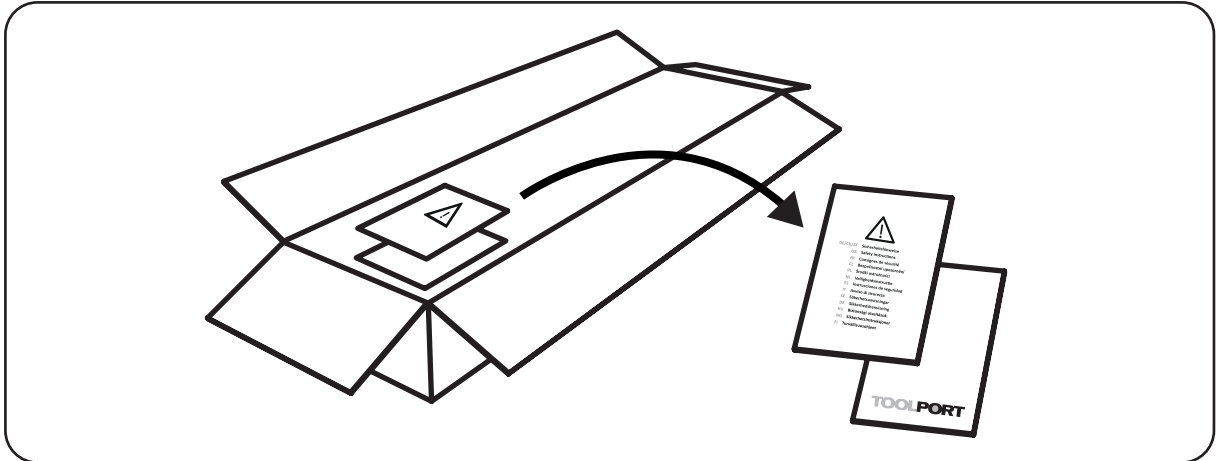

**B**

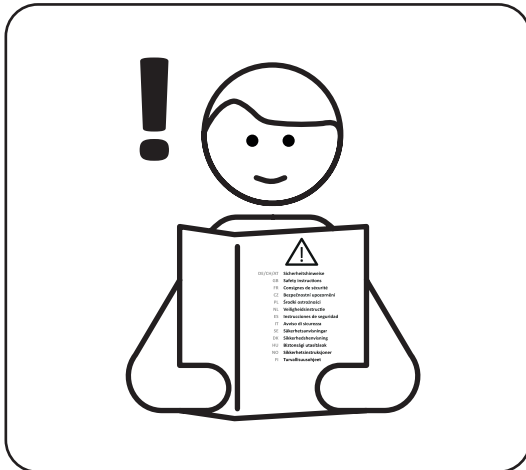



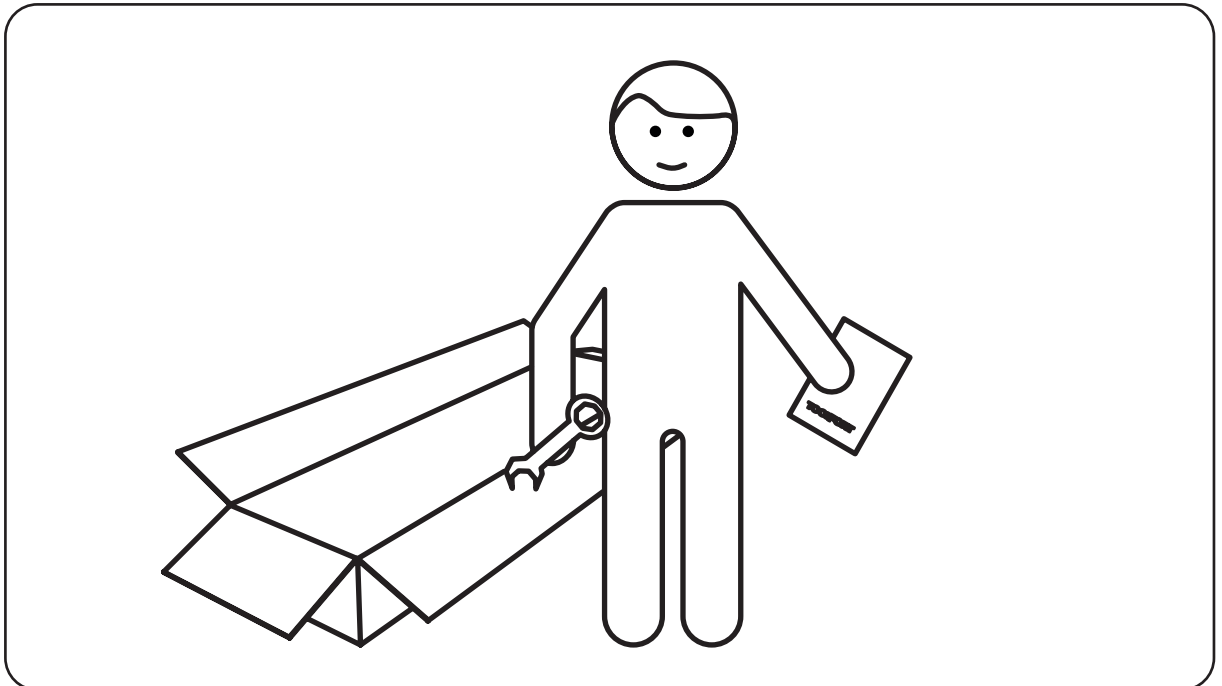

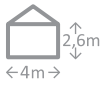

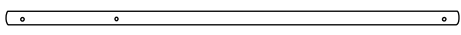
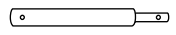
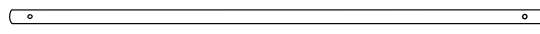
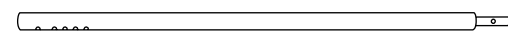
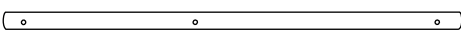
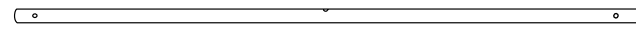
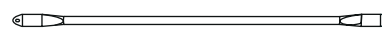
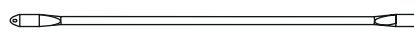

**C**

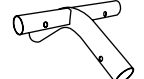
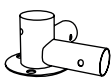
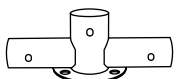

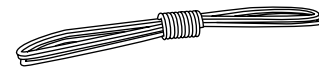

# PT-L2-Q1-2.6 4 m x 6 m, 4 m x 8 m, 4 m x 10 m

Item no.		4 m	6 m	8 m	10 m	12 m
32648	 Ø50 mm ← 1483 mm →	6	8	10	12	14
32649	 Ø50 mm ← 632 mm →	6	8	10	12	14
31597	 Ø38 mm ← 1895 mm →	4	4	4	4	4
32220	 Ø50 mm ← 1283 mm →	6	8	10	12	14
32221	 Ø50 mm ← 1283 mm →	6	8	10	12	14
31136	 Ø38 mm ← 1916 mm →	10	15	20	25	30
30437_E	 Ø25 mm ← 1174 mm →	4	4	4	4	4
30359_E	 Ø25 mm ← 1652 mm →	3	4	5	6	7
31137		6	6	6	6	6
31138		3	6	9	12	15
33338		4	4	4	4	4
35902		2	4	6	8	10
35900		2	2	2	2	2
30430_E		106	128	150	172	194
30429_E		18	18	18	18	18
30085		4	4	4	4	4
30051		6	8	10	12	14

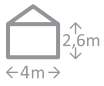

# PT-L2-Q1-2.6 4 m x 6 m, 4 m x 8 m, 4 m x 10 m

Item no.		4 m	6 m	8 m	10 m	12 m
31459	M6 	1	1	1	1	1
30382_E	M8 	1	1	1	1	1
30081	 ← 935 mm →	8	12	16	20	24
30080		4	6	8	10	12
33096		6	8	10	12	14
30052		6	8	10	12	14
30384_E	M6 30 mm 	6	8	10	12	14
30404_E	M6 45 mm 	4	4	4	4	4
30405_E	M6 65 mm 	4	4	4	4	4
30407_E	M6 	8	8	8	8	8
30914	M8 50 mm 	28	38	48	58	68
30915	M8 70 mm 	32	42	52	62	72
30760	M8 	60	80	100	120	140
30048	 ← 300 mm →	6	8	10	12	14
30046_E	 ← 180 mm →	12	18	24	30	36
30222_E	 ← 400 mm →	6	8	10	12	14
		1	1	1	1	1
		4	6	8	10	12
		2	2	2	2	2

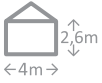

**PT-L2-Q1-2.6** 4 m x 6 m, 4 m x 8 m, 4 m x 10 m

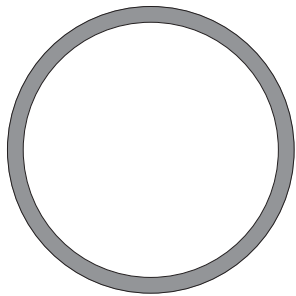
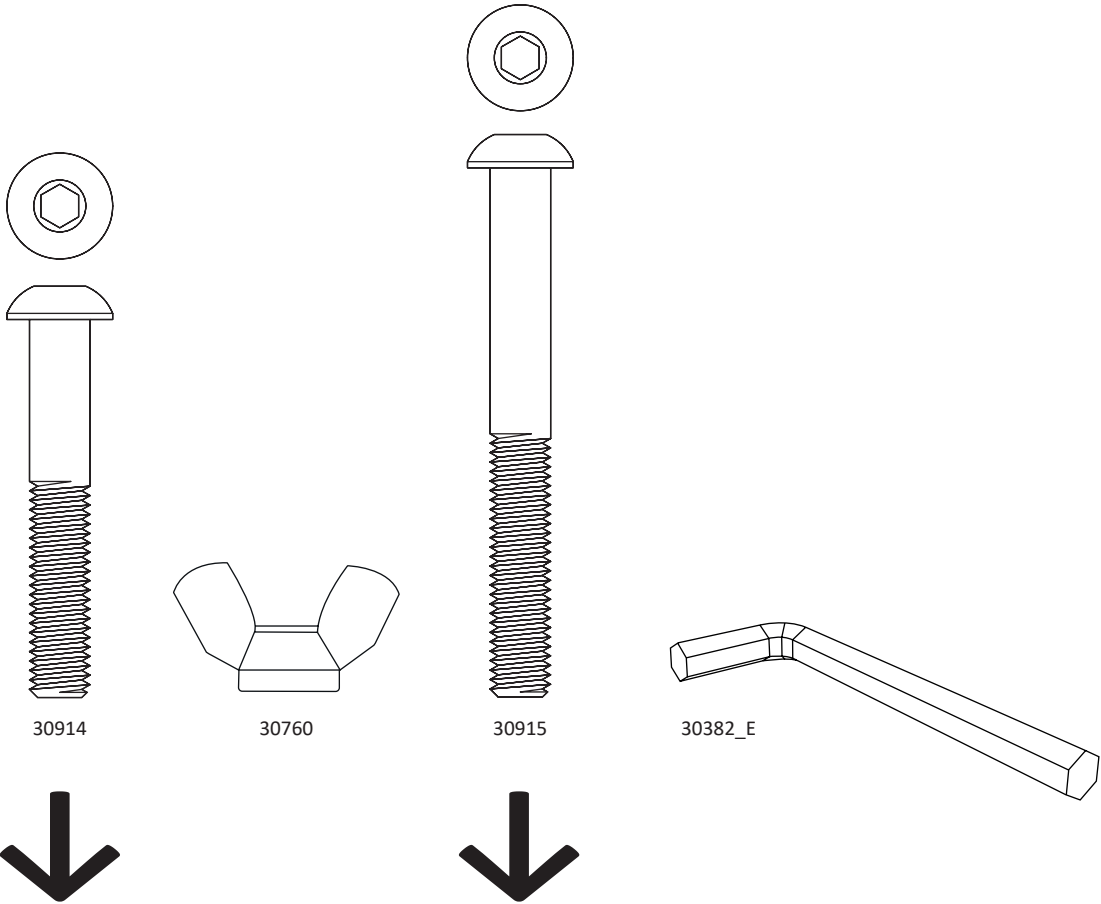

Ø 38mm

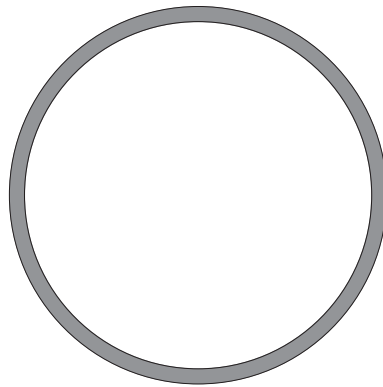

Ø 50mm

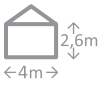

# PT-L2-Q1-2.6 4 m x 6 m, 4 m x 8 m, 4 m x 10 m

1

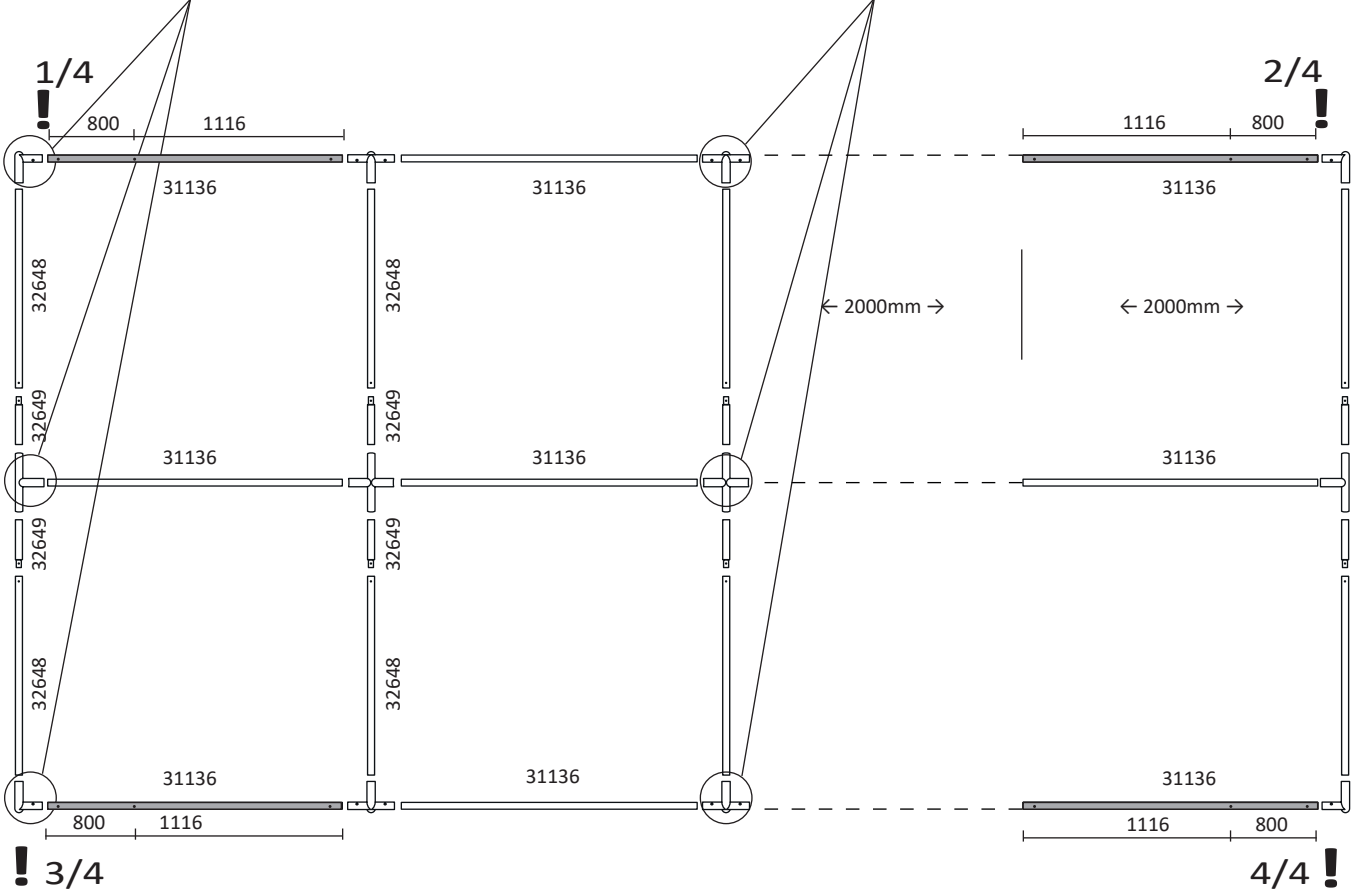
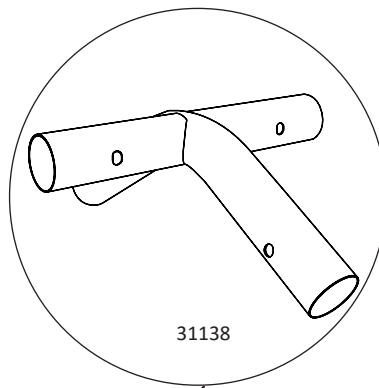
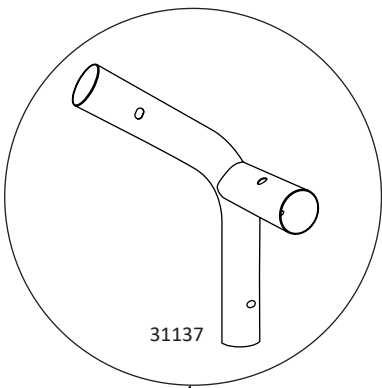
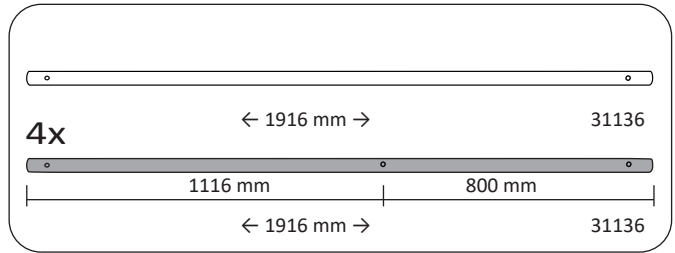
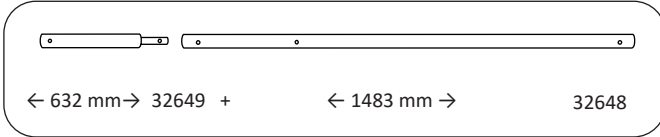

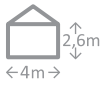

# PT-L2-Q1-2.6 4 m x 6 m, 4 m x 8 m, 4 m x 10 m

2

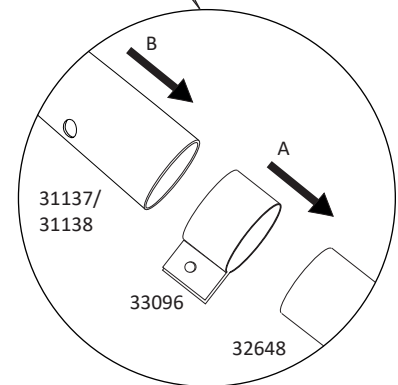
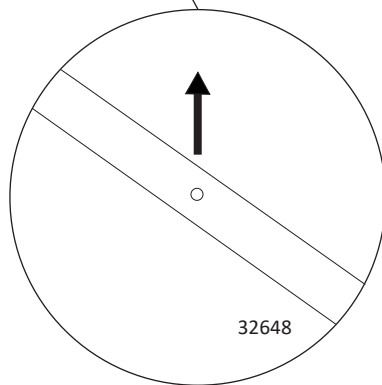
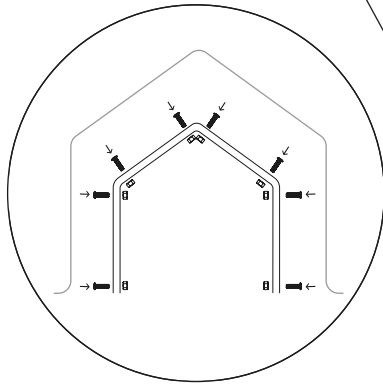
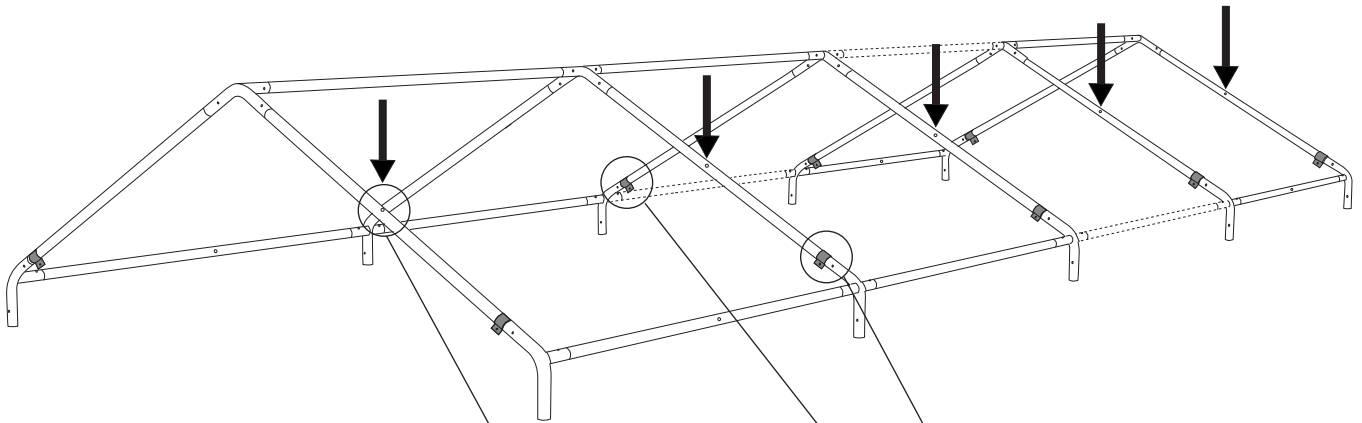
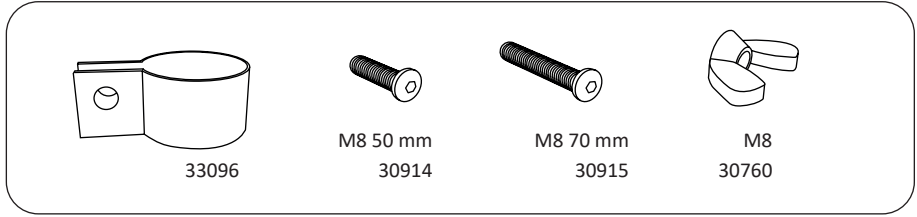



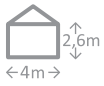

# PT-L2-Q1-2.6 4 m x 6 m, 4 m x 8 m, 4 m x 10 m

3

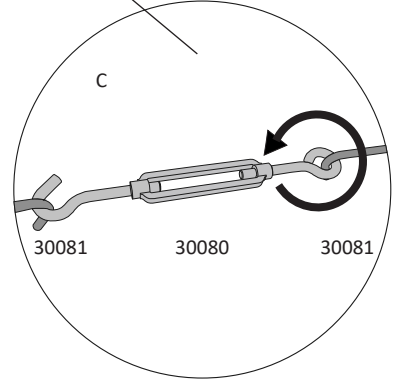
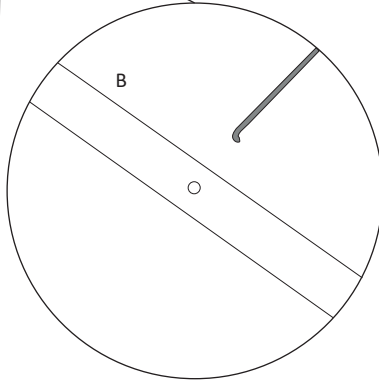
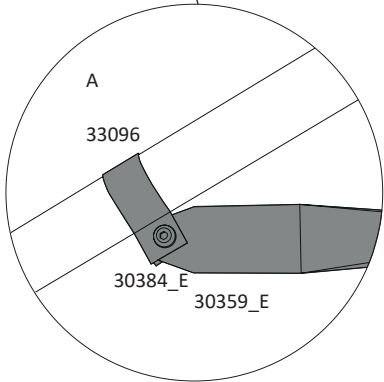
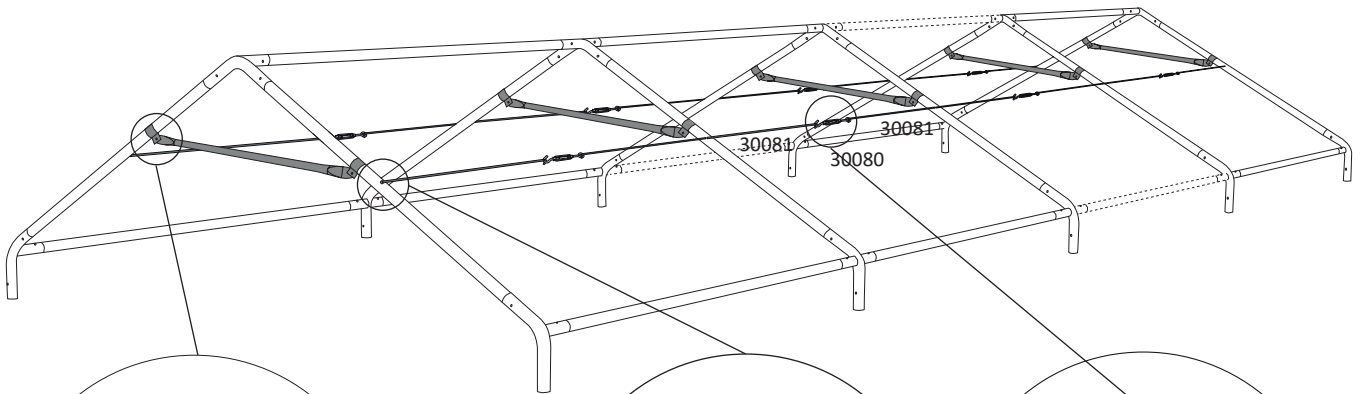
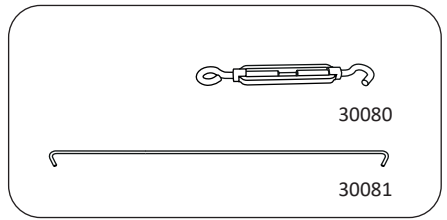
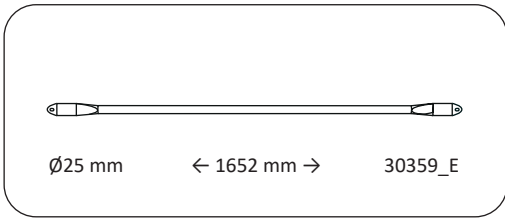
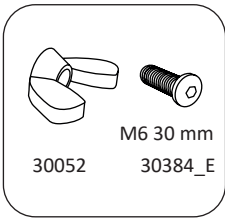

4

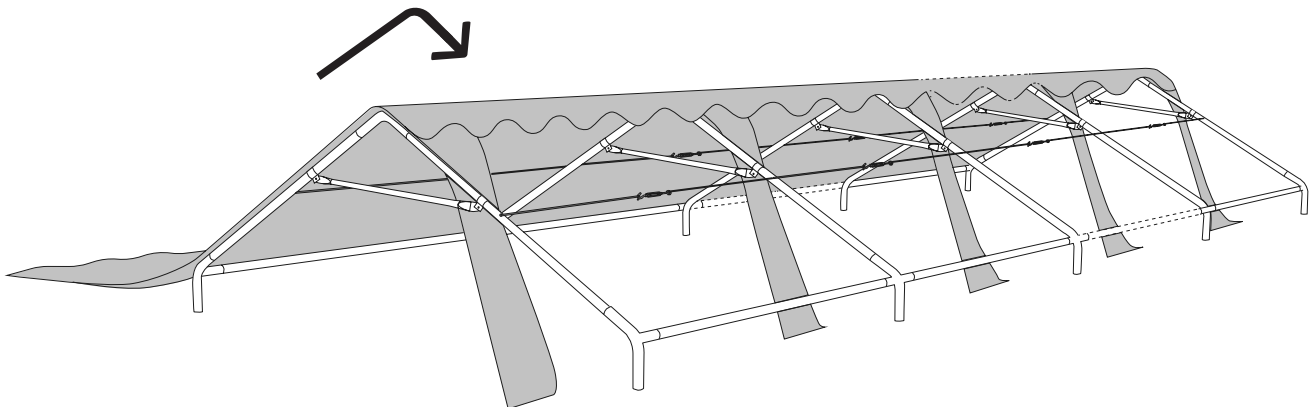
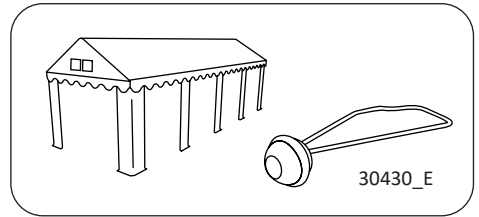

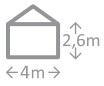

# PT-L2-Q1-2.6 4 m x 6 m, 4 m x 8 m, 4 m x 10 m

5

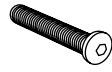

M8 70 mm  
30915



M8  
30760

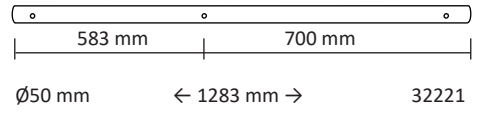

Ø50 mm    ← 1283 mm →    32221

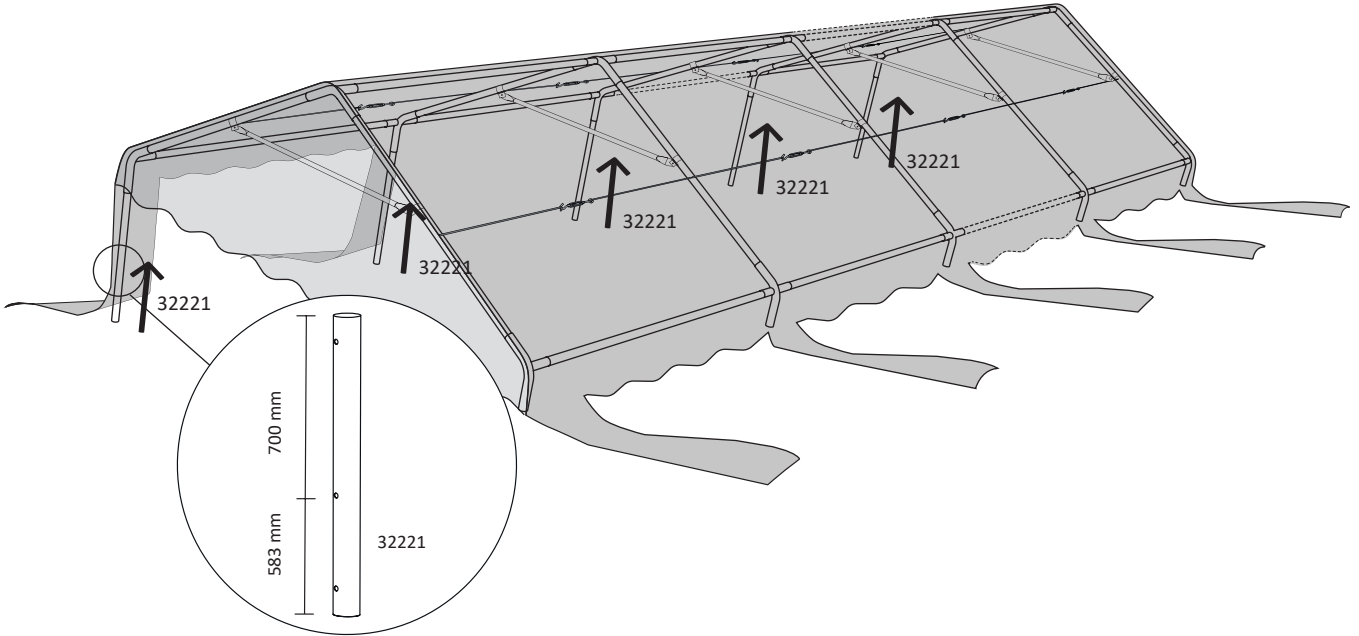

6



M6 45 mm  
30404\_E



M6 65 mm  
30405\_E



M6  
30407\_E



Ø25 mm    ← 1174 mm →    30437\_E

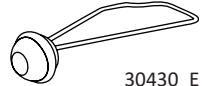

30430\_E

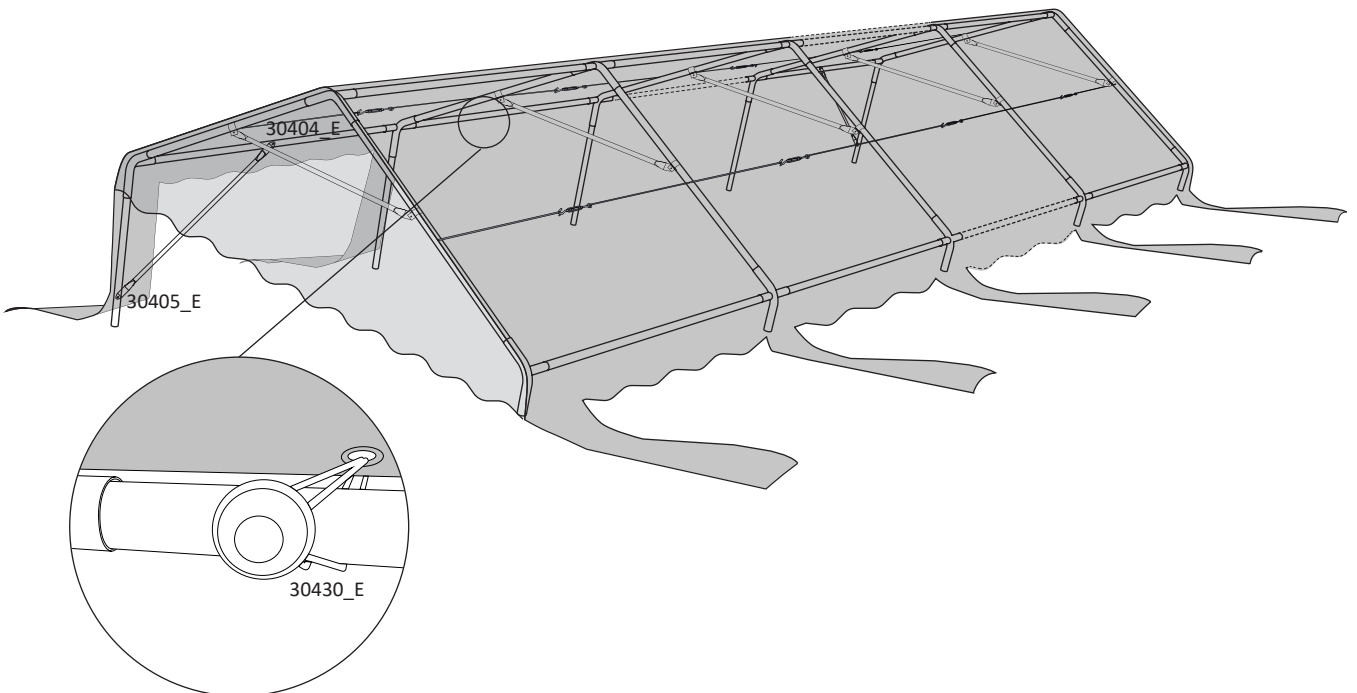

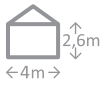

# PT-L2-Q1-2.6 4 m x 6 m, 4 m x 8 m, 4 m x 10 m

7

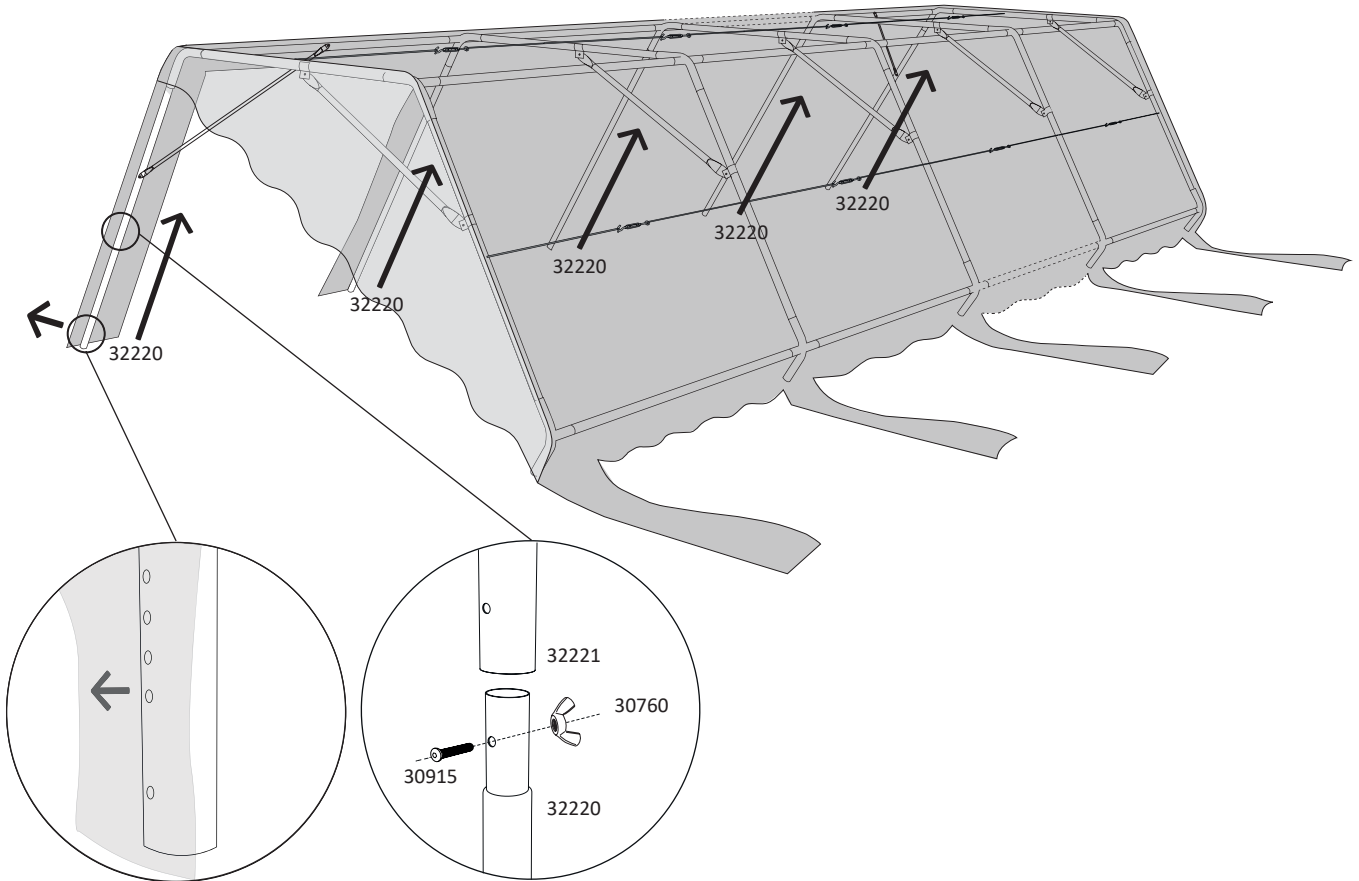
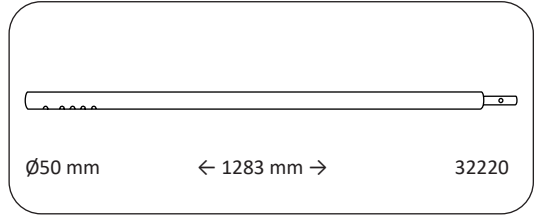
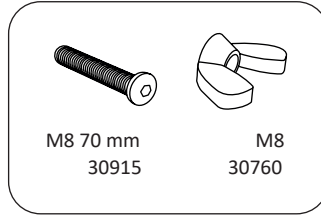

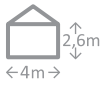

# PT-L2-Q1-2.6 4 m x 6 m, 4 m x 8 m, 4 m x 10 m

8

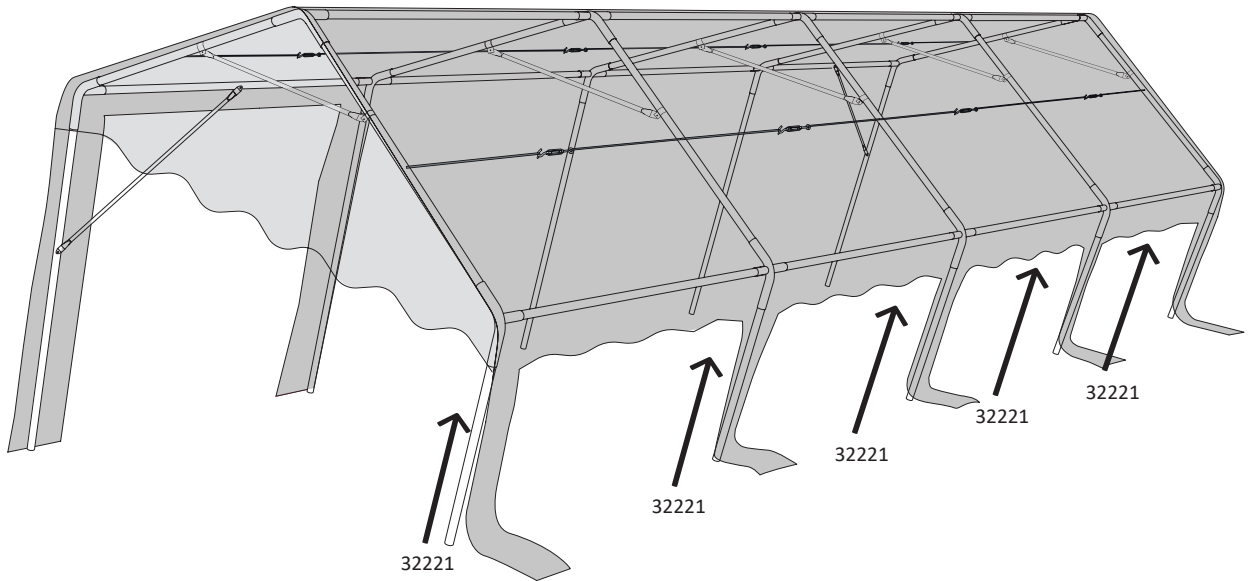
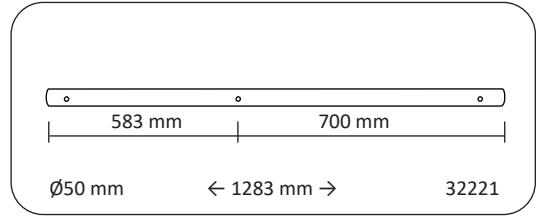
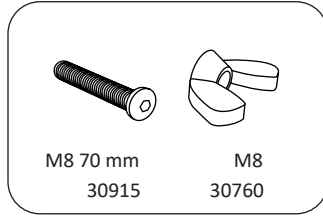

9

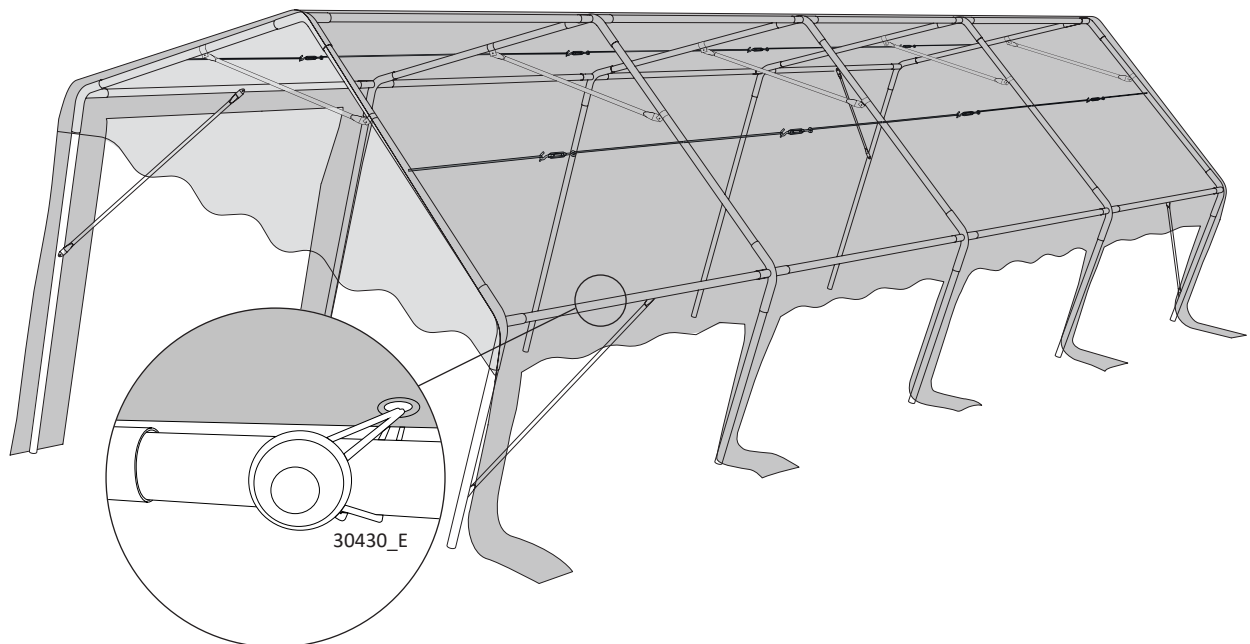
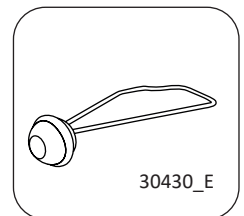
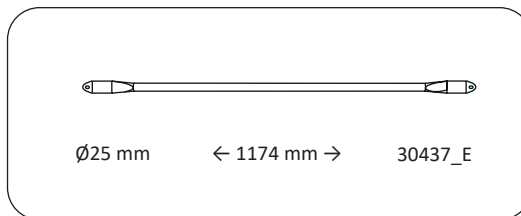
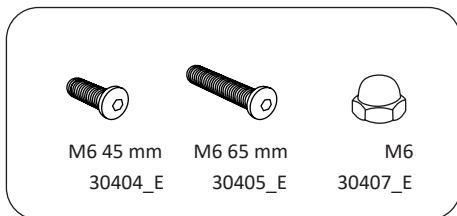

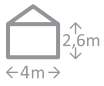

# PT-L2-Q1-2.6 4 m x 6 m, 4 m x 8 m, 4 m x 10 m

10

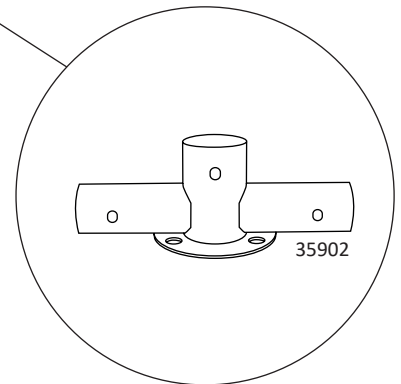
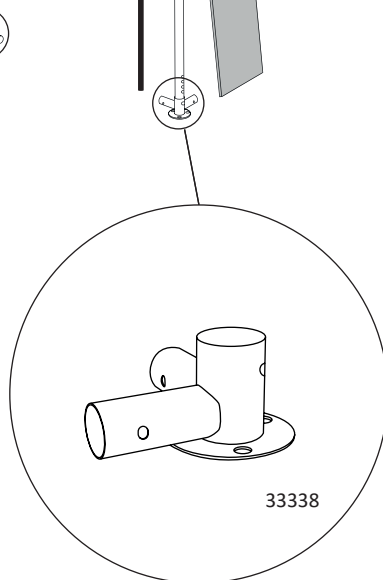
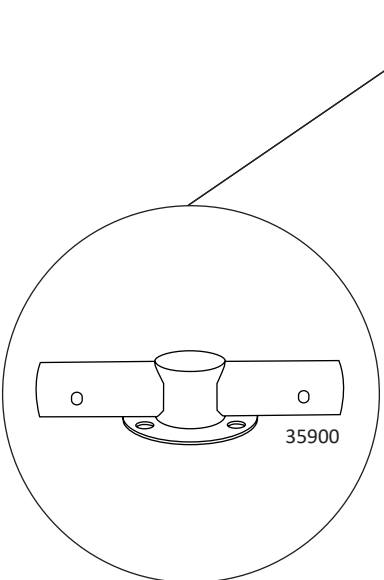
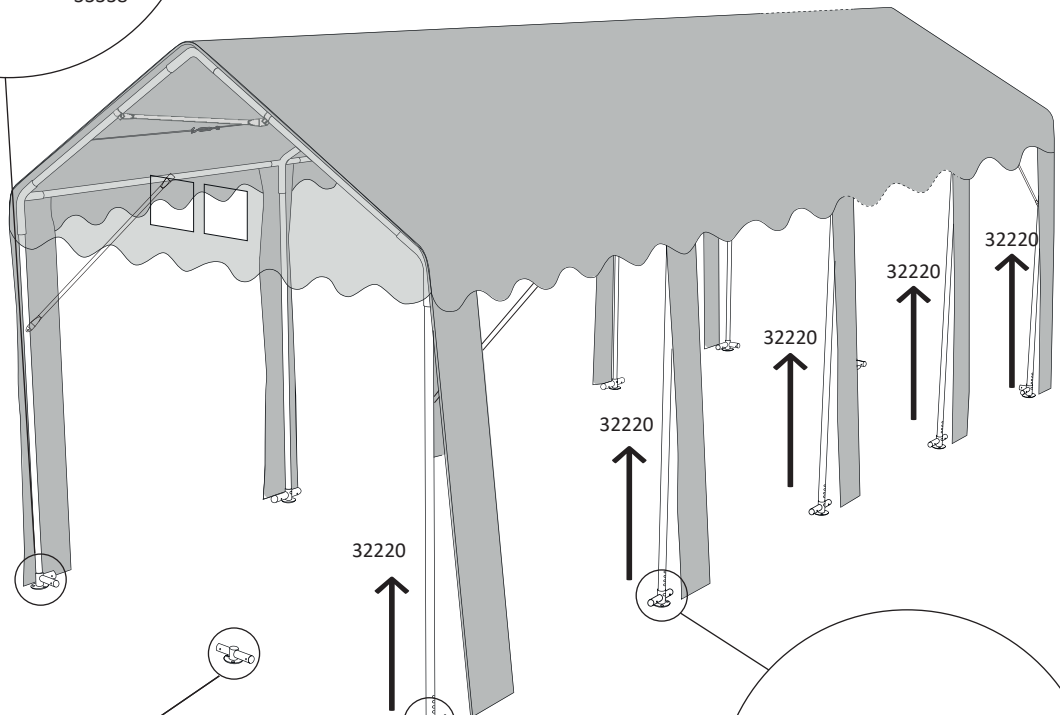
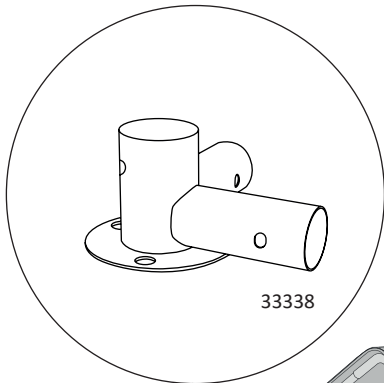
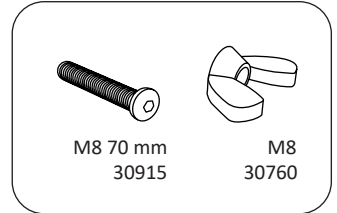
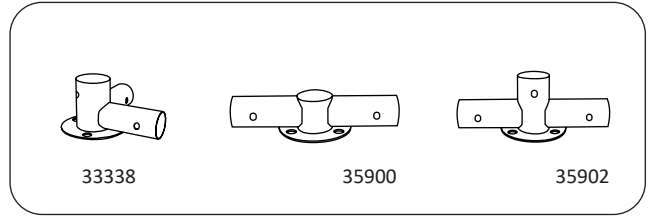
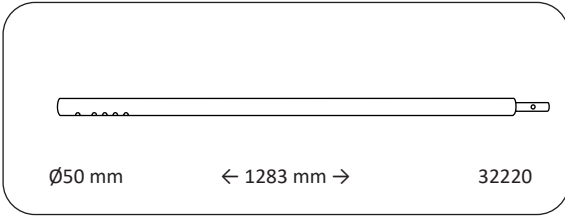

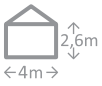

# PT-L2-Q1-2.6 4 m x 6 m, 4 m x 8 m, 4 m x 10 m

11

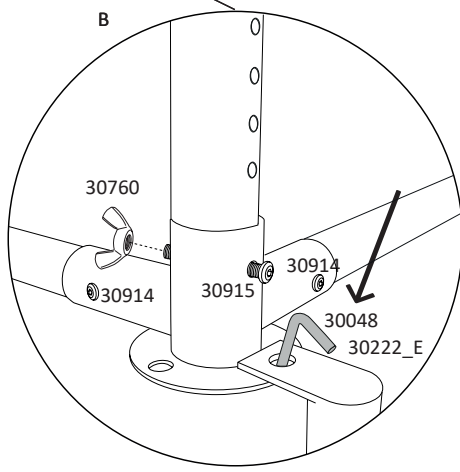
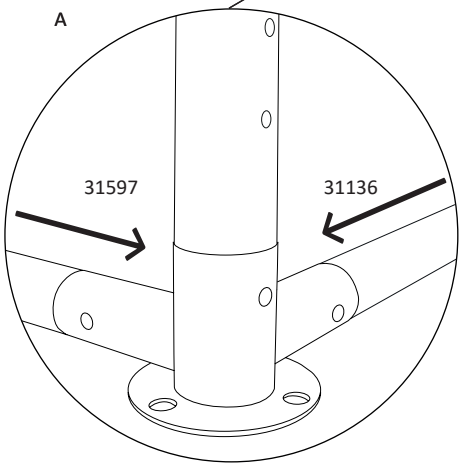
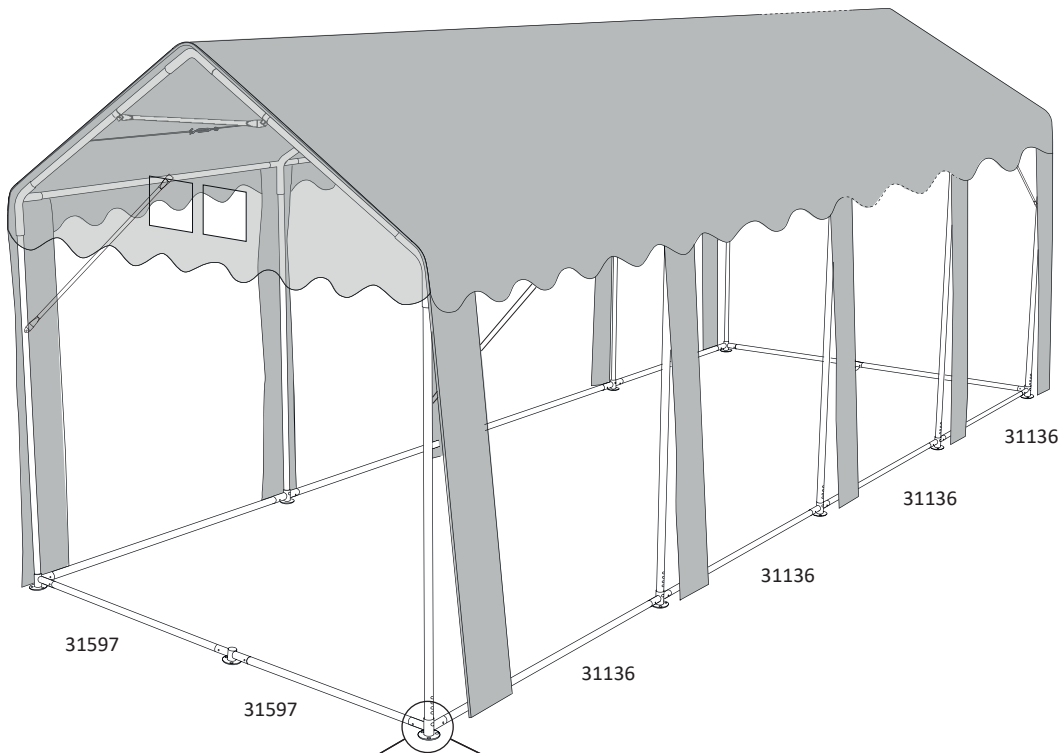
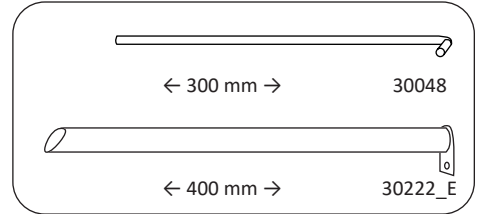
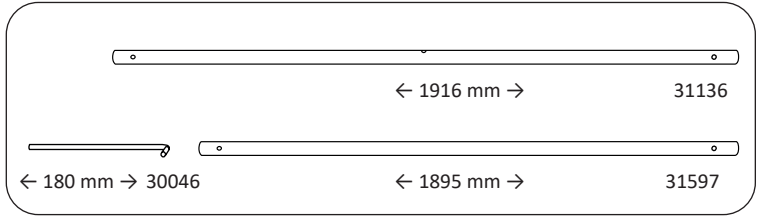
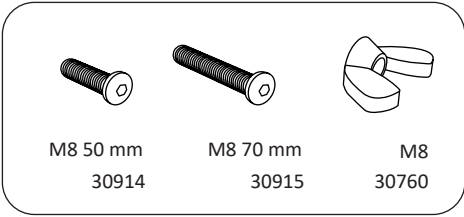

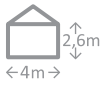

**PT-L2-Q1-2.6** 4 m x 6 m, 4 m x 8 m, 4 m x 10 m

12

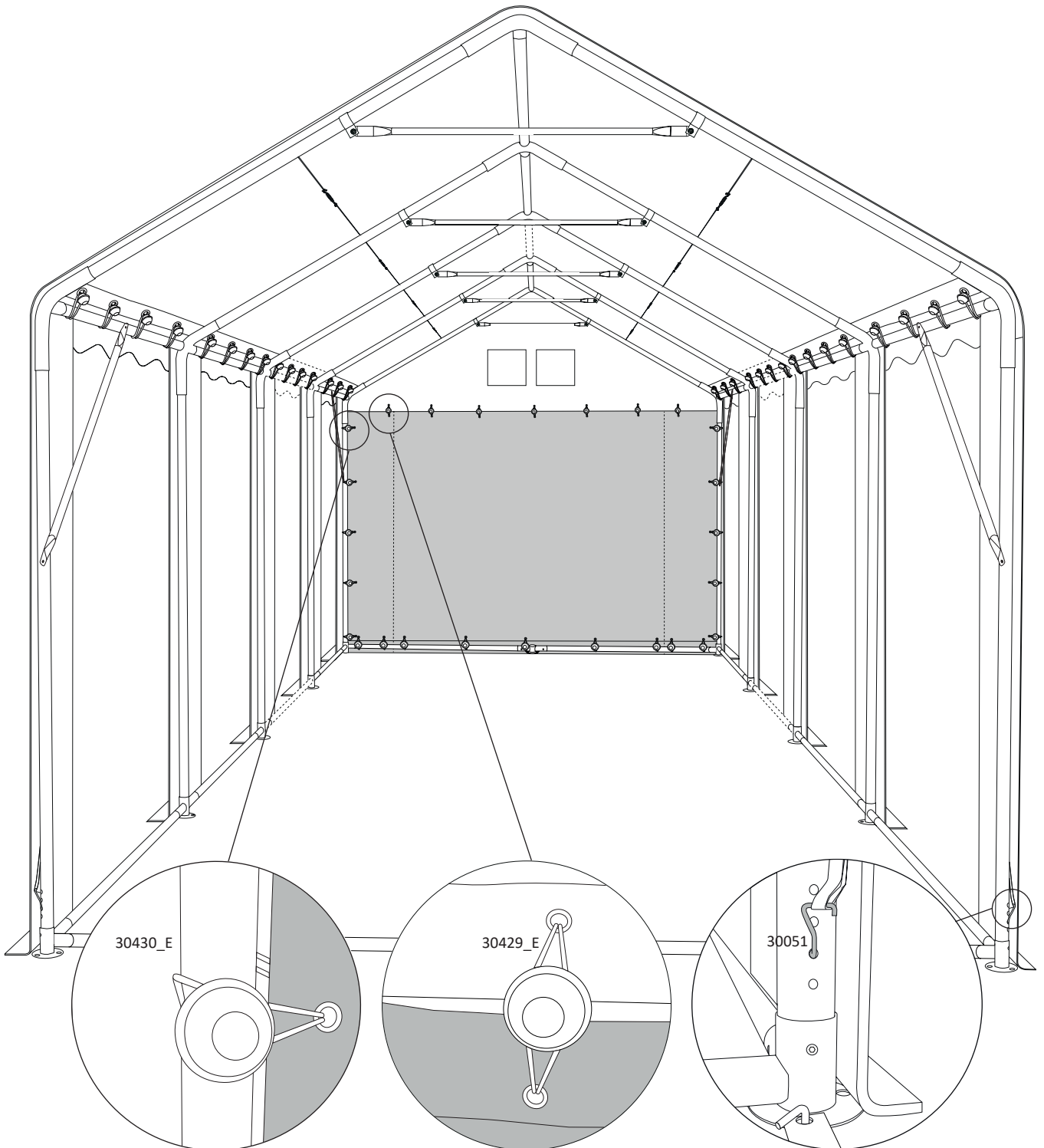
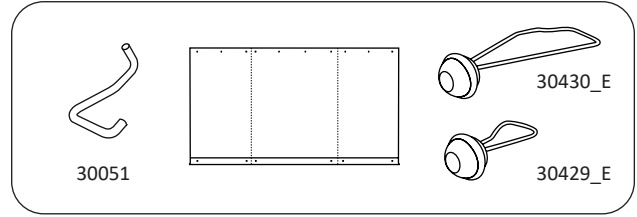

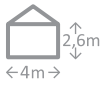

**PT-L2-Q1-2.6** 4 m x 6 m, 4 m x 8 m, 4 m x 10 m

13

